

**NOT MEASUREMENT
SENSITIVE**

**MIL-STD-2525D
10 JUNE 2014**

**SUPERSEDING
MIL-STD-2525C
17 NOVEMBER 2008**

DEPARTMENT OF DEFENSE INTERFACE STANDARD

JOINT MILITARY SYMBOLOGY



Distribution A: Approved for public release, distribution is unlimited.

AMSC N/A

AREA INST

FOREWORD

1. This standard is approved for use by all departments and agencies of the Department of Defense (DOD) and available for use by non-DOD entities (e.g., first responders, United Nations, and multinational partners).

2. This standard provides a standardized, structured set of graphical symbols for the display of information in command and control (C2) systems and applications. A standard method for symbol construction is provided using common building blocks which shall be used to create current symbol sets as well as for creating sets that may be needed in the future. This includes frame, icon, modifier, and amplifier using color, graphic, and alphanumeric representations. It provides requirements for symbol construction and composition with flexibility for special user's needs.

3. In joint military operations, it is imperative to have a common language clearly understood among all users. Graphical representation of objects of interest (e.g., units, installations, equipment, control measures, activities, and meteorological occurrences) are observed and readily understood faster than merely text alone. This is valid even more for a user population with a widely different background of language, component, knowledge, and experience. A common standard of joint military symbols is therefore an important element to enhance efficiency and to contribute to success in joint operations.

4. This revision has resulted in many changes to the standard, but the most significant ones are as follows:

a. Restructuring of the standard to build symbols from components, including frame, icon, first modifier, second modifier, and amplifiers, rather than pre-define all possible symbols.

b. Aligning more closely with North Atlantic Treaty Organization (NATO) Standardization Agreement (STANAG) 2019/Allied Procedural Publication (APP)-6(C), NATO Joint Military Symbology.

c. Realigning appendixes into space, air, land, sea surface, subsurface, activities, control measures, meteorological and oceanographic (METOC), signals intelligence (SIGINT), three dimensional, and cyberspace.

5. Comments, suggestions, or questions on this document should be addressed to Defense Information Systems Agency (DISA) Standards Management Branch (EE32), P.O. Box 549, Ft. Meade, MD 20755-0549, or emailed to disa.meade.EE.mbx.symbology@mail.mil. Since contact information can change, you may want to verify the currency of this address information using the ASSIST [Acquisition Streamlining and Standardization Information System] online database at <https://assist.dla.mil/>.

CONTENTS

<u>PARAGRAPH</u>	<u>PAGE</u>
FOREWORD	i
CONTENTS.....	ii
1 SCOPE.....	1
1.1 Scope.....	1
2 APPLICABLE DOCUMENTS	1
2.1 General.....	1
2.2 Government documents	1
2.2.1 Specifications, standards, and handbooks.....	1
2.2.2 Other Government documents, drawings and publications	2
2.3 Order of precedence	3
3 DEFINITIONS.....	3
3.1 Acronyms and abbreviations used in this standard.....	3
3.2 Definitions used in this standard.....	3
3.2.1 Amplifier.....	3
3.2.2 Area.....	4
3.2.3 Assumed friend	4
3.2.4 Atmospheric environment phenomena.	4
3.2.5 Attribute	4
3.2.6 Boundary.....	4
3.2.7 C2 (Command and Control).....	4
3.2.8 Civil support.....	4
3.2.9 Combat effectiveness	4
3.2.10 Commission Internationale de l'Eclairage (CIE).	4
3.2.11 Contact	4
3.2.12 Control measure symbol	4
3.2.13 Defended area	4
3.2.14 Dynamic amplifier	4
3.2.15 Engineering design symbology.....	5
3.2.16 Faker	5
3.2.17 Field	5
3.2.18 Frame	5
3.2.19 Friend	5
3.2.20 Geospatial intelligence (GEOINT)	5
3.2.21 Graphic.....	5
3.2.22 Hostile	5

3.2.23 Icon	5
3.2.24 Icon-based symbol	5
3.2.25 Installation.....	5
3.2.26 Interoperability.....	5
3.2.27 Joint military symbology	6
3.2.28 Joker.....	6
3.2.29 Kilo	6
3.2.30 Lollipopping.....	6
3.2.31 Meteorological symbology.	6
3.2.32 Modifier	6
3.2.33 Neutral.....	6
3.2.34 Oceanic environment phenomena.....	6
3.2.35 Operational environment	6
3.2.36 Ownship	6
3.2.37 Pending	6
3.2.38 Point.	6
3.2.39 Signals intelligence (SIGINT)	6
3.2.40 Staff.....	6
3.2.41 Static amplifier.....	6
3.2.42 Suspect	7
3.2.43 Symbol	7
3.2.44 Symbol identification code (SIDC).	7
3.2.45 Text	7
3.2.46 Track	7
3.2.47 Traveler	7
3.2.48 Unknown.....	7
3.2.49 Zombie	7
4 GENERAL REQUIREMENTS	7
4.1 Command and control symbols	7
4.2 Other symbols	7
4.3 Joint military symbology sets	7
4.4 Monochromatic and hand-drawn symbols.....	8
4.5 Symbol recognition and legibility.....	8
5 DETAILED REQUIREMENTS	8
5.1 Objective.....	8
5.2 Organization.....	8
5.3 Icon-based symbols.....	8
5.3.1 Bounding octagon.....	9

5.3.1.1 Bounding octagon and frames.	9
5.3.1.2 The bounding octagon and icons/modifiers	11
5.3.2 Frame	11
5.3.2.1 Standard identity.	15
5.3.2.2 Domain.....	15
5.3.2.3 Status.....	15
5.3.3 Fill	16
5.3.4 Icons	18
5.3.4.1 Main icons.....	18
5.3.4.2 Full octagon icons.	18
5.3.4.3 Full frame icons.	18
5.3.5 Modifiers.....	19
5.3.6 Amplifiers	19
5.3.6.1 Echelon indicator	23
5.3.6.2 Installation indicator.	24
5.3.6.3 Task force indicator.	24
5.3.6.4 Feint/dummy indicator.....	24
5.3.6.5 Offset location amplifier	24
5.3.6.6 Altitude/depth modifier.....	25
5.3.6.6.1 Altitude base reference point	25
5.3.6.6.2 Relative altitude	25
5.3.6.6.3 Flight level	25
5.3.6.6.4 Multiple instances of altitude/depth modifiers	25
5.3.6.7 Date-time group.	26
5.3.6.8 Direction of movement amplifier.....	26
5.3.6.9 Mobility indicator	26
5.3.6.10 Auxiliary equipment indicator.	27
5.3.6.11 Text modifiers.....	28
5.3.6.12 Dynamic graphic amplifiers.....	28
5.3.6.12.1 Area of uncertainty amplifier.....	30
5.3.6.12.1.1 Ellipse AOU amplifier	30
5.3.6.12.1.2 Bearing box AOU amplifier.....	30
5.3.6.12.1.3 Line of bearing AOU amplifier.....	30
5.3.6.12.2 Dead reckoning trailer amplifier	30
5.3.6.12.2.1 Line DR trailer amplifier	30
5.3.6.12.2.2 Farthest-on circle DR trailer amplifier.....	30
5.3.6.12.3 Speed leader amplifier	30
5.3.6.12.4 Pairing line amplifier	31

5.3.6.12.5 Dynamic towed sensor array amplifier	31
5.3.6.13 Operational condition amplifier	31
5.3.6.14 Engagement amplifier bar	32
5.3.6.14.2.1 For hostile targets	34
5.3.6.14.3 Engagement amplifier bar structure	34
5.3.6.14.3.1 Remote and local engagements	34
5.3.6.14.3.2 Engagement stage	34
5.3.6.14.3.3 Weapons assignment or deployment	35
5.3.7 Manually-generated tracks	36
5.3.8 Composition of icon-based symbols	36
5.3.8.1 Symbol display hierarchy	37
5.3.9 Symbol size	39
5.3.10 Line width	39
5.3.11 Plotting	39
5.3.12 Orientation	39
5.4 Compliance criteria	39
5.4.1 Appearance of tactical symbols	39
5.4.2 Appearance of tactical graphics	40
5.4.3 Assembling and parsing of SIDC	40
5.5 Color	40
6 NOTES	42
6.1 Intended use	42
6.2 Subject term (key word) listing	43
6.3 International standardization agreement implementation	43
6.4 Changes from previous issue	43
APPENDIX A - SYMBOL IDENTIFICATION CODES	45
A.1 SCOPE	45
A.1.1 Scope	45
A.2 APPLICABLE DOCUMENTS	45
A.3 DEFINITIONS	45
A.4 GENERAL REQUIREMENTS	45
A.4.1 Organization	45
A.5 DETAILED REQUIREMENTS	45
A.5.1 Symbol identification codes	45
A.5.2 Elements of the symbol identification codes	45
A.5.2.1 Set A - First ten digits	45
A.5.2.2 Set B - Second ten digits	45
A.5.2.3 Set C - Conditional version extension	46

A.5.3 Set A.....	47
A.5.3.1 Version.....	47
A.5.3.2 Standard identity	47
A.5.3.3 Symbol set.....	48
A.5.3.4 Status.....	48
A.5.3.5 Headquarters/Task Force/Dummy	49
A.5.3.6 Echelon/Mobility/Towed Array Amplifier.....	49
A.5.4 Set B.....	50
A.5.4.1 Air (01).....	51
A.5.4.2 Air missile (02).	54
A.5.4.3 Space (05).	55
A.5.4.4 Space missile (06).	57
A.5.4.5 Land unit (10).....	58
A.5.4.6 Land civilian unit/organization (11).	67
A.5.4.7 Land Equipment (15).	68
A.5.4.8 Land installations (20).	75
A.5.4.9 Control measure (25).	80
A.5.4.10 Sea surface (30).....	97
A.5.4.11 Sea subsurface (35).	101
A.5.4.12 Mine warfare (36).	104
A.5.4.13 Activities (40).	106
A.5.4.14 Atmospheric (45).	111
A.5.4.15 Oceanographic (46).....	117
A.5.4.16 Meteorological space (47).....	123
A.5.4.17 Signals intelligence equipment (50, 51, 52, 53, 54).....	123
A.5.4.18 Cyberspace (60).	125
A.5.5 Third Ten Digits.....	126
APPENDIX B - SPACE SYMBOLS	127
B.1 SCOPE	127
B.1.1 Scope	127
B.2 APPLICABLE DOCUMENTS.....	127
B.3 DEFINITIONS	127
B.4 GENERAL REQUIREMENTS	127
B.4.1 Organization.....	127
B.5 DETAILED REQUIREMENTS	127
B.5.1 Technical specifications.....	127
B.5.2 Symbol identification coding scheme	127
B.5.3 Composition of space symbols.....	127

B.5.3.1 Symbol building process	128
B.5.3.2 Icons and modifiers	129
B.5.3.3 Amplifiers.....	129
B.5.3.3.1 Text amplifiers	129
B.5.3.3.2 Graphic amplifiers.....	130
B.6 SPACE EQUIPMENT AND PLATFORM SYMBOLS	130
B.6.1 Space equipment and platform symbols.....	130
B.6.2 Space equipment and platform icons	130
B.6.3 Space equipment and platform sector 1 modifiers	136
B.6.4 Space equipment and platform sector 2 modifiers	137
B.7 SPACE MISSILE SYMBOLS	137
B.7.1 Space missile symbols.....	137
B.7.2 Space missile icons.....	137
B.7.3 Space missile sector 1 modifiers.	138
B.7.4 Space missile sector 2 modifiers.	138
APPENDIX C - AIR SYMBOLS	141
C.1 SCOPE	141
C.1.1 Scope	141
C.2 APPLICABLE DOCUMENTS	141
C.3 DEFINITIONS	141
C.4 GENERAL REQUIREMENTS	141
C.4.1 Organization	141
C.5 DETAILED REQUIREMENTS	141
C.5.1 Technical specifications	141
C.5.2 Symbol identification coding scheme	141
C.5.3 Composition of air symbols	141
C.5.3.1 Symbol building process	142
C.5.3.2 Icons and modifiers	143
C.5.3.3 Amplifiers.....	143
C.5.3.3.1 Heading	143
C.5.3.3.2 Graphic amplifiers.....	144
C.6 AIR EQUIPMENT AND PLATFORM SYMBOLS	145
C.6.1 Air equipment and platform symbols.....	145
C.6.2 Air equipment and platform icons.....	145
C.6.3 Air equipment and platform sector 1 modifiers	152
C.6.4 Air equipment and platform sector 2 modifiers	157
C.7 AIR MISSILE SYMBOLS	159
C.7.1 Air missile symbols.....	159

C.7.2 Air missile icons.....	159
C.7.3 Air missile sector 1 modifiers.	159
C.7.4 Air missile sector 2 modifiers	161
APPENDIX D - LAND SYMBOLS.....	165
D.1 SCOPE.....	165
D.1.1 Scope.....	165
D.2 APPLICABLE DOCUMENTS.....	165
D.3 DEFINITIONS.....	165
D.4 GENERAL REQUIREMENTS	165
D.4.1 Organization.....	165
D.5 DETAILED REQUIREMENTS	165
D.5.1 Technical specifications.....	165
D.5.2 Symbol identification coding scheme	165
D.5.3 Composition of land symbols	165
D.5.3.1 Symbol building process	166
D.5.3.2 Icons and modifiers.....	167
D.5.3.3 Amplifiers.	167
D.5.3.3.1 Text amplifiers	167
D.5.3.3.2 Graphic amplifiers.....	171
D.5.3.3.2.1 Headquarters staff amplifier.....	171
D.5.3.3.2.2 Echelon amplifier.....	172
D.6 LAND UNIT SYMBOLS	172
D.6.1 Land unit symbols.....	172
D.6.2 Land unit icons.....	172
D.6.2.1 Land unit icons – special entity subtypes.....	205
D.6.3 Land unit sector 1 modifiers	206
D.6.4 Land unit sector 2 modifiers	216
D.7 LAND CIVILIAN INDIVIDUALS/ORGANIZATION SYMBOLS	223
D.7.1 Land civilian individuals/organization symbols	223
D.7.2 Land civilian individuals/organization icons	223
D.7.3 Land civilian unit/organization sector 1 modifiers	225
D.7.4 Land civilian unit sector 2 modifiers	228
D.8 LAND EQUIPMENT SYMBOLS.....	229
D.8.1 Land equipment symbols.	229
D.8.2 Land equipment icons	229
D.8.3 Land equipment sector 1 modifiers.....	268
D.9 LAND INSTALLATION SYMBOLS.....	269
D.9.1 Land installation symbols	269

D.9.2 Land installation icons	269
D.9.3 Land installation sector 1 modifiers.....	294
D.9.4 Land installation sector 2 modifiers.....	296
APPENDIX E - SEA SURFACE SYMBOLS	299
E.1 SCOPE.....	299
E.1.1 Scope	299
E.2 APPLICABLE DOCUMENTS	299
E.3 DEFINITIONS	299
E.4 GENERAL REQUIREMENTS.....	299
E.4.1 Organization	299
E.5 DETAILED REQUIREMENTS	299
E.5.1 Technical specifications	299
E.5.2 Symbol identification coding scheme	299
E.5.3 Composition of sea surface symbols	299
E.5.3.1 Symbol building process.	300
E.5.3.2 Icons and modifiers.	300
E.5.3.3 Amplifiers.....	301
E.5.3.3.1 Text amplifiers.....	301
E.5.3.3.2 Graphic amplifiers	302
E.6 SEA SURFACE UNIT, EQUIPMENT AND INSTALLATION SYMBOLS	302
E.6.1 Sea surface unit, equipment and installation symbols.....	302
E.6.2 Sea surface unit, equipment and installation icons.....	302
E.6.3 Sea surface unit, equipment and installation sector 1 modifiers	319
E.6.4 Sea surface unit, equipment and installation sector 2 modifiers	322
E.6.5 Sea surface local tracks.	324
E.6.5.1 Fused tracks.....	324
APPENDIX F - SUBSURFACE SYMBOLS	327
F.1 SCOPE.....	327
F.1.1 Scope.....	327
F.2 APPLICABLE DOCUMENTS	327
F.3 DEFINITIONS	327
F.4 GENERAL REQUIREMENTS.....	327
F.4.1 Organization.	327
F.5 DETAILED REQUIREMENTS.....	327
F.5.1 Technical specifications.....	327
F.5.2 Symbol identification coding scheme.....	327
F.5.3 Composition of subsurface symbols.....	327
F.5.3.1 Symbol building process.....	328

F.5.3.2 Icons and modifiers.....	329
F.5.3.3 Amplifiers.....	329
F.6 SUBSURFACE UNIT, EQUIPMENT and INSTALLATION SYMBOLS	331
F.6.1 Subsurface unit, equipment and installation symbols.....	331
F.6.2 Subsurface unit, equipment and installation icons.	331
F.6.3 Subsurface unit, equipment and installation sector 1 modifiers.....	334
F.6.4 Subsurface unit, equipment and installation sector 2 modifiers	336
F.6.5 Subsurface local tracks	338
F.6.5.1 Fused tracks.	338
F.7 MINE WARFARE SYMBOLS.....	339
F.7.1 Mine warfare symbols	339
F.7.2 Mine warfare icons	339
APPENDIX G - ACTIVITIES SYMBOLS.....	353
G.1 SCOPE	353
G.1.1 Scope.....	353
G.2 APPLICABLE DOCUMENTS.....	353
G.3 DEFINITIONS.....	353
G.4 GENERAL REQUIREMENTS	353
G.4.1 Organization.....	353
G.5 DETAILED REQUIREMENTS	353
G.5.1 Technical specifications.....	353
G.5.2 Symbol identification coding scheme.....	353
G.5.3 Composition of activities symbols.....	353
G.5.3.1 Symbol building process.....	354
G.5.3.2 Icons and modifiers.....	355
G.5.3.3 Amplifiers.	355
G.5.3.3.1 Text amplifiers	355
G.5.3.3.2 Graphic amplifiers.....	357
G.6 ACTIVITIES SYMBOLS.....	357
G.6.1 Activities symbols.....	357
G.6.2 Activities icons.....	357
G.6.3 Activities sector 1 modifiers.	383
APPENDIX H - CONTROL MEASURE SYMBOLS.....	387
H.1 SCOPE	387
H.1.1 Scope.....	387
H.2 APPLICABLE DOCUMENTS.....	387
H.3 DEFINITIONS.....	387
H.4 GENERAL REQUIREMENTS	387

H.4.1 Organization.....	387
H.5 DETAILED REQUIREMENTS	387
H.5.1 Control measure symbols.....	387
H.5.1.1 Composition of control measure symbols.....	388
H.5.1.1.1 Standard identity (color rules) for control measure symbols	388
H.5.1.1.2 Point control measure height.....	388
H.5.1.1.3 Status	388
H.5.1.1.4 Amplifiers.	389
H.5.1.1.5 Direction of movement indicator	391
H.5.1.1.6 Echelon indicator.	391
H.5.1.1.7 Offset location indicator.....	392
H.5.1.1.8 Text amplifier.....	392
H.5.1.1.9 Altitude/depth amplifier	392
H.5.1.1.10 Altitude base reference point.	392
H.5.1.1.10.1 Relative altitude..	392
H.5.1.1.10.2 Flight level	392
H.5.1.1.10.3 Multiple instances of altitude/depth amplifiers.....	392
H.5.1.1.11 Date-time group	393
H.5.2 Construction of control measure symbols.....	393
H.5.2.1 Point control measure symbols.	393
H.5.2.2 Line and area control measure symbols.....	393
H.5.3 Coloring	393
H.5.4 Labeling	393
H.5.4.1 Fonts.....	394
H.5.5 Command and Control.....	394
H.5.5.1 Boundaries.	394
H.5.6 Points.....	397
H.5.7 Lines.....	398
H.5.8 Areas	398
H.5.9 Area of operations.....	399
H.5.10 Command and control measure symbols..	401
H.5.11 Maneuver Control Measure Symbols	410
H.5.12 Defensive maneuver.....	420
H.5.12.1 Areas.	420
H.5.12.2 Observation post.	425
H.5.13 Offensive maneuver	428
H.5.13.1 Axis of advance.....	428
H.5.13.2 Direction of attack.....	432

H.5.14 Maneuver control measure symbols	440
H.5.14.1 Maneuver control measure symbols	440
H.5.15 Airspace Control Measures (Means).....	448
H.5.15.1 Airspace control measures (means).	448
H.5.16 Maritime control measures.....	466
H.5.16.1 Maritime control measures.....	466
H.5.17 Deception control measures	504
H.5.17.1 Deception control measures	504
H.5.18 Fire Support Coordination Measures	507
H.5.18.1 Fire Support Coordination Measures	507
H.5.19 Targets.....	525
H.5.19.1 Targets.....	525
H.5.20 Target acquisition.....	537
H.5.20.1 Target acquisition.....	537
H.5.21 Obstacles.	572
H.5.21.1 Obstacles	572
H.5.22 Field fortification control measures.	603
H.5.22.1 Field fortification.	603
H.5.23 CBRN defense control measure symbols.....	606
H.5.23.1 CBRN defense.....	606
H.5.24 Sustainment control measures.....	615
H.5.24.1 Sustainment control measures.....	615
H.5.25 Supply points.....	623
H.5.25.1 Supply point	623
H.5.26 Mission Tasks.	636
H.5.26.1 Mission Task Symbols.....	636
H.5.27 Intelligence control measures.....	656
H.5.27.1 Intelligence control measure symbols.....	656
H.5.28 Abbreviations and Acronyms for Use with Control Measure Symbols.....	657
H.5.28.1 Boundary abbreviations and acronyms	657
H.5.28.2 Unit functions abbreviation and acronyms	658
APPENDIX I - METEOROLOGICAL AND OCEANOGRAPHIC SYMBOLOGY	659
I.1 SCOPE.....	659
I.1.1 Scope	659
I.2 APPLICABLE DOCUMENTS	659
I.3 DEFINITIONS	659
I.4 GENERAL REQUIREMENTS.....	659
I.4.1 Organization.	659

I.5 DETAILED REQUIREMENTS.....	659
I.5.1 Technical specifications.	659
I.5.2 Symbology identification coding scheme.....	659
I.5.3 Symbology set	659
APPENDIX J - SIGNALS INTELLIGENCE SYMBOLS	771
J.1 SCOPE.....	771
J.1.1 Scope	771
J.2 APPLICABLE DOCUMENTS	771
J.3 DEFINITIONS	771
J.4 GENERAL REQUIREMENTS	771
J.4.1 Organization	771
J.5 DETAILED REQUIREMENTS	771
J.5.1 Technical specifications	771
J.5.2 Symbol identification coding scheme	771
J.5.3 Composition of SIGINT symbols.....	771
J.5.3.1 Symbol building process.	772
J.5.3.2 Icons and modifiers..	772
J.5.3.3 Amplifiers.....	773
J.6 SIGINT SYMBOLS	773
J.6.1 SIGINT symbols.....	773
J.6.2 SIGINT icons.	773
J.6.3 SIGINT sector 1 modifiers.....	774
APPENDIX K - USE OF WARFIGHTING SYMBOLS IN PSEUDO-THREE-DIMENSIONAL (2.5D) DISPLAYS	783
K.1 SCOPE	783
K.1.1 Scope.....	783
K.2 REFERENCES.....	783
K.3 DEFINITIONS.....	783
K.3.1 Billboarding	783
K.3.2 Cubing.....	783
K.3.3 Curve (line)	783
K.3.4 Geospatial.....	783
K.3.5 Glyph.....	783
K.3.6 Icon.....	783
K.3.7 Image.....	784
K.3.8 Marker post (lollipop)	784
K.3.9 Model	784
K.3.10 Pictograph	784

K.3.11 Point	784
K.3.12 Solid (volume).....	784
K.3.13 Surface (area)	784
K.3.14 Symbicon	784
K.3.15 Symbol.	784
K.3.16 Terrain draping.....	784
K.3.17 Three-dimensional	784
K.3.18 Two-dimensional.	784
K.4 PSEUDO-THREE-DIMENSIONAL (2.5D) SYMBOLIZATION	784
K.4.1 Introduction.....	784
K.4.2 When to use 2.5D displays.....	785
K.4.3 Taxonomy of symbols and displays.....	786
K.4.3.1 Subject Area.....	786
K.4.3.2 Delineation Type.....	786
K.4.3.3 Degree of Abstraction.	786
K.4.3.4 Dimensionality.	786
K.4.3.5 Relative to terrain.....	787
K.4.4 Geospatial (map) symbols.....	787
K.4.4.1 Raster data.....	787
K.4.4.2 Vector data	787
K.4.5 Imagery	787
K.4.6 Optimum display method.....	787
K.5 GUIDANCE AND PORTRAYAL CONSIDERATIONS IN PSEUDO-THREE-DIMENSIONAL (2.5D) DISPLAYS	787
K.5.1 Use of 2D symbols in 2.5D display	787
K.5.1.1 Visualization of icons.....	788
K.5.1.1.1 Terrain draping.....	788
K.5.1.1.2 Billboarding	788
K.5.1.1.3 Cubing.....	789
K.5.1.1.4 Marker post	790
K.5.1.2 Visualization of control measure symbols	791
K.5.1.3 Symbicon..	793
K.5.2 Pseudo-three-dimensional models	793
K.5.2.1 Modeling and Simulation (M&S) standards.....	794
K.5.2.2 Model libraries	794
K.5.3 Design considerations for symbology in a 2.5D display.	794
K.5.3.1 Symbol location	794
K.5.3.1.1 Submergence of symbols	795

K.5.3.1.2 Height above/below terrain surface.	795
K.5.3.1.3 Estimating track position.	795
K.5.3.2 Perspective.	795
K.5.3.3 Direction indicators.....	796
K.5.4 Text amplifiers for symbols.....	796
K.5.5 Speed vectors and trailing lines.....	797
K.5.6 Incomplete data.....	797
K.5.7 Vertical exaggeration of terrain and tactical symbols.....	797
K.5.8 Implications for training and doctrine.....	798
K.6 NOTES.....	798
K.6.1 Graphics displayed.....	798
APPENDIX L - CYBERSPACE SYMBOLS.....	799
L.1 SCOPE.....	799
L.1.1 Scope.....	799
L.2 APPLICABLE DOCUMENTS.....	799
L.3 DEFINITIONS.....	799
L.4 GENERAL REQUIREMENTS.....	799
L.4.1 Organization.....	799
L.5 DETAILED REQUIREMENTS.....	799
L.5.1 Technical specifications..	799
L.5.2 Symbol identification coding scheme.....	799
L.5.3 Composition of cyberspace symbols.....	799
L.5.3.1 Symbol building process.....	800
L.5.3.2 Icons and modifiers.....	800
L.5.3.3 Amplifiers.....	800
L.6 CYBERSPACE SYMBOLS.....	800
L.6.1 Cyberspace symbols.....	800
L.6.2 Cyberspace icons. Table L-II depicts cyberspace icons.....	801
INDEX.....	809
CONCLUDING MATERIAL.....	869

1 SCOPE

1.1 Scope. This military standard (MIL-STD) establishes the rules and requirements to develop and display joint military symbology within the Department of Defense (DOD) and non-DOD entities.

2 APPLICABLE DOCUMENTS

2.1 General. The documents listed in this section are specified in sections [3](#), [4](#), or [5](#) of this standard. This section does not include documents cited in other sections of this standard or recommended for additional information or as examples. While every effort has been made to ensure the completeness of this list, document users are cautioned that they must meet all specified requirements of documents cited in this standard, whether or not they are listed.

2.2 Government documents.

2.2.1 Specifications, standards, and handbooks. The following specifications, standards and handbooks form a part of this document to the extent specified herein. Unless otherwise specified, the issues of these documents are those cited in the solicitation or contract.

INTERNATIONAL STANDARDIZATION AGREEMENTS (STANAG)(NATO)

STANAG 1166	-	Standard Ship Designator System
STANAG 1241	-	NATO Standard Identity Description Structure for Tactical Use
STANAG 2019/APP-6-	-	NATO Joint Military Symbology
STANAG 2511	-	Intelligence Reports
STANAG 5522	-	NATO Improved Link Eleven (NILE) - Link 22

DEPARTMENT OF DEFENSE (DOD) STANDARDS

MIL-STD-1472	-	Department of Defense Design Criteria Standard: Human Engineering
MIL-STD-1787	-	Aircraft Display Symbology
MIL-STD-2401	-	Department of Defense World Geodetic System (WGS)
MIL-STD-3011	-	Joint Range Extension Application Protocol (JREAP)
MIL-STD-6016	-	Department of Defense Interoperability Standard: Tactical Data Link (TDL) Link-16 Message Standard
MIL-STD-6017	-	Department of Defense Interoperability Standard: Variable Message Format (VMF) Message Standard

MIL-STD-2525D

- MIL-STD-6018 - Department of Defense Interface Standard: Integrated Broadcast Service (IBS) Common Message Format (CMF) Standard
- MIL-STD-6040 - Department of Defense Interface Standard: United States Message Text Format (USMTF) Description

(Copies of these documents are available online at <https://assist.dla.mil/>, <http://quicksearch.dla.mil/> or from the Standardization Document Order Desk, 700 Robbins Avenue, Building 4D, Philadelphia, PA 19111-5094.)

2.2.2 Other Government documents, drawings and publications. The following other Government documents, drawings and publications form a part of this document to the extent specified herein. Unless otherwise specified, the issues of these documents are those cited in the solicitation or contract.

JOINT PUBLICATIONS (JP)

- JP 1-02 - Department of Defense Dictionary of Military and Associated Terms
- JP 3-0 - Joint Operations
- JP 3-09 - Joint Fire Support
- JP 3-52 - Joint Airspace Control
- JP 3-59 - Meteorological and Oceanographic Operations

(Copies of these documents are available at <https://jdeis.js.mil/jdeis/>.)

AIR FORCE HANDBOOK (AFH)

- AFH 11-203 - Weather for Aircrews

(Copies of this document are available online at <http://www.e-publishing.af.mil/>.)

ARMY FIELD MANUALS (FM) AND TRAINING CIRCULAR (TC)

- FM 1-02 - Operational Terms and Graphics
- ADRP 1-02 - Operational Terms and Military Symbols
- ADP 5-0 - The Operations Process

(Copies of these documents are available at http://armypubs.army.mil/doctrine/Active_FM.html, http://armypubs.army.mil/doctrine/ADP_1.html and http://armypubs.army.mil/doctrine/ADRP_1.html.)

NATIONAL GEOSPATIAL-INTELLIGENCE AGENCY (NGA) STANDARD

NGA.STND.0033 - Geopolitical Entities, Names and Codes (GENC) Standard

(Copies of this document are available online at <https://nsgreg.nga.mil/genc/registers.jsp>.)

2.3 Order of precedence. Unless otherwise noted herein or in the contract, in the event of a conflict between the text of this document and the references cited herein, the text of this document takes precedence. Nothing in this document, however, supersedes applicable laws and regulations unless a specific exemption has been obtained.

3 DEFINITIONS

3.1 Acronyms and abbreviations used in this standard. The acronyms used in this standard are defined as follows:

AAP	Allied administrative publication
ADP	Army doctrine publication
ADRP	Army doctrine reference publication
AOU	area of uncertainty
APP	allied procedural publication
ASSIST	Acquisition Streamlining and Standardization Information System
C2	command and control
CBRN	chemical, biological, radiological, and nuclear
CIE	Commission Internationale de l'Eclairage
DISA	Defense Information Systems Agency
DOD	Department of Defense
DR	dead reckoning
HSL	hue, saturation and luminance
ISO	International Organization for Standardization
JP	joint publication
JSSG	Joint Service specification guide
METOC	meteorological and oceanographic
MIL-STD	military standard
NATO	North Atlantic Treaty Organization
RGB	red, green, blue
SIGINT	signals intelligence
STANAG	NATO standardization agreement
USMTF	United States message text format
VMF	variable message format

3.2 Definitions used in this standard. Terms used in this document are defined as follows. The source of the definition is cited in parentheses. Unless otherwise annotated, this publication is the proponent for all terms and definitions found in the glossary.

3.2.1 Amplifier. Optional text or graphics that provide additional information about a symbol and are always located outside the frame area.

3.2.2 Area. 1. A flat piece of ground or open space. 2. A distinct space or surface, or one having a special function. (Refer to FM 1-02 for the definition of specific types of areas.)

3.2.3 Assumed friend. A track which is assumed to be a friend because of its characteristics, behavior, or origin. ([STANAG 1241](#))

3.2.4 Atmospheric environment phenomena. A term used to describe natural phenomena occurring in the envelope of air surrounding the Earth, including its interfaces and interactions with the Earth's solid or liquid surface.

3.2.5 Attribute. A distinctive feature or characteristic such as line, shape, color, texture (fill), edge, mass and value.

3.2.6 Boundary. A line that delineates surface areas for the purpose of facilitating coordination and deconfliction of operations between adjacent units, formations, or areas. (JP 1-02)

3.2.7 C2 (Command and Control). The exercise of authority and direction by a properly designated commander over assigned and attached forces in the accomplishment of the mission. Command and control functions are performed through an arrangement of personnel, equipment, communications, facilities, and procedures employed by a commander in planning, directing, coordinating, and controlling forces and operations in the accomplishment of the mission.

3.2.8 Civil support. Department of Defense support to US civil authorities for domestic emergencies and for designated law enforcement and other activities. ([JP 1-02](#)) An overarching term encompassing various military missions, tasks and activities conducted inside the United States in coordination with other instruments of national power to maintain or reestablish a safe and secure environment, provide essential governmental services, emergency infrastructure reconstruction and humanitarian relief.

3.2.9 Combat effectiveness. The ability of a unit to perform its mission. Factors such as ammunition, personnel, fuel status, and weapon systems are evaluated and rated. ([ADRP 1-02](#))

3.2.10 Commission Internationale de l'Eclairage (CIE). A color space chart widely used to describe the range of color seen by the human eye.

3.2.11 Contact. In air intercept, a term meaning, "Unit has an unevaluated target."

3.2.12 Control measure symbol. A category of joint military symbology that provides information about objects necessary for battlefield planning and management.

3.2.13 Defended area. An area the Source Track Number (STN) is capable of defending against ballistic missiles, etc, (i.e., the Source TN is operational with ready weapons and has designated the area for defense). ([MIL-STD-6016](#))

3.2.14 Dynamic amplifier. An amplifier whose size and placement are based on the attributes of an object and can change as these attributes and the scale of the background change.

3.2.15 Engineering design symbology. Symbology used to design, plan and develop engineering drawings in the chemical, electrical, civil, mechanical and structural engineering fields.

3.2.16 Faker. A friendly track acting as a hostile for exercise purposes. ([STANAG 1241](#))

3.2.17 Field. A defined area in which a limited combination of alphanumeric and other characters, amplifiers and/or abbreviations are grouped/situated in an established way around a symbol/icon, line, area, point, or boundary and used for the purpose of providing additional information about the associated object or operational environment geometry.

3.2.18 Frame. The geometric border of a symbol that provides an indication of the standard identity, battle dimension and status of a joint military object.

3.2.19 Friend. A track belonging to a declared, presumed or recognized friendly nation, faction or group. ([STANAG 1241](#))

3.2.20 Geospatial intelligence (GEOINT). The exploitation and analysis of imagery and geospatial information to describe, assess and visually depict physical features and geographically referenced activities on the Earth. Geospatial intelligence consists of imagery, imagery intelligence and geospatial information. Also called GEOINT. ([JP 2-03](#))

3.2.21 Graphic. Any and all products of the cartographic and photogrammetric art. A graphic may be a map, chart, mosaic or even a film strip that was produced using cartographic techniques. (AAP-6)

3.2.22 Hostile. A track whose characteristics, behaviour or origin indicate that it is a threat to friendly forces. Designation as hostile does not necessarily imply clearance to engage. (STANAG 1241) In identification, the designation given to a track, object or entity whose characteristics, behaviour or origin indicate that it is a threat to friendly forces. Designation as hostile does not necessarily imply clearance to engage. (AAP-6)

3.2.23 Icon. The innermost part of a symbol that provides a graphic representation of an object.

3.2.24 Icon-based symbol. A category of joint symbology that provides information about the standard identity, battle dimension, status and mission of an object.

3.2.25 Installation. A grouping of facilities which support particular functions. Installations may be elements of a base.

3.2.26 Interoperability. The condition achieved among communications-electronics systems or items of communications-electronics equipment when information or services can be exchanged directly and satisfactorily between them and/or their users. The degree of interoperability should be defined when referring to specific cases. ([JP 1-02](#))

3.2.27 Joint military symbology. Symbology used to plan and execute joint military operations in support of C2 functions. These symbols fall into two basic categories: icon-based symbols and control measure symbols.

3.2.28 Joker. A friendly track acting as a suspect for exercise purposes. ([STANAG 1241](#))

3.2.29 Kilo. A friendly track of special interest. ([STANAG 1241](#))

3.2.30 Lollipopping. The placing of a symbol above the ground surface on a map using a marker post. The user can set an arbitrary height above the ground surface and drop down lines connecting the symbol to its ground location without having the symbol actually cover the location on the map.

3.2.31 Meteorological symbology. Symbology used in weather/climatic forecasting.

3.2.32 Modifier. A pictorial or alphanumeric component that provides additional information about the icon and are always located inside the frame area.

3.2.33 Neutral. A track or contact whose characteristics, behaviour, origin, or nationality indicate that it is neither supporting nor opposing friendly forces. ([STANAG 1241](#))

3.2.34 Oceanic environment phenomena. A term used to describe natural phenomena occurring on or below the surface of the earth's oceans and seas.

3.2.35 Operational environment. A composite of the conditions, circumstances and influences that affect the employment of capabilities and bear on the decisions of the commander. ([JP 1-02](#))

3.2.36 Ownship. The visual representation of the ship that the operator is currently occupying.

3.2.37 Pending. Tracks which have not been subject to the identification process but which are available for reporting may be reported with a status of pending. ([STANAG 1241](#))

3.2.38 Point. A position, place, spot, or locality. (Refer to [FM 1-02](#) for the definition of specific types of points.) A symbol that has only one set of coordinates.

3.2.39 Signals intelligence (SIGINT). 1. A category of intelligence comprising either individually or in combination all communications intelligence, electronic intelligence, and foreign instrumentation signals intelligence, however transmitted. 2. Intelligence derived from communications, electronics, and foreign instrumentation signals. ([JP 1-02](#))

3.2.40 Staff. A straight line used as a headquarters amplifier in a symbol or used to connect a symbol with its location on a map, chart, or display. The free end of the staff indicates the direction or the intended direction of movement of the track or object.

3.2.41 Static amplifier. An amplifier whose size and placement are fixed and remain constant.

3.2.42 Suspect. A track that is potentially hostile because of its characteristics, behavior, origin, or nationality. ([STANAG 1241](#))

3.2.43 Symbol. A graphic object that presents information.

3.2.44 Symbol identification code (SIDC). A numeric code based on a hierarchical structure that provides the elements required to construct the basic symbol.

3.2.45 Text. Words, alphanumeric information and other American Standard Code for Information Interchange (ASCII) characters used to define or further designate the meaning of a symbol.

3.2.46 Track. 1. A series of related contacts displayed on a data display console or other display device. 2. To display or record the successive positions of a moving object. 3. The actual path of an aircraft above or a ship on the surface of the earth. ([JP 1-02](#)) The course is the path that is planned; the track is the path that is actually taken.

3.2.47 Traveler. A suspect surface track following a recognized travel route. ([STANAG 1241](#))

3.2.48 Unknown. An evaluated track that has not been identified. ([STANAG 1241](#)) An identity applied to an evaluated track that has not been identified. ([JP 1-02](#))

3.2.49 Zombie. A suspect air track conforming to air traffic control (ATC) rules or following a recognized traffic pattern. ([STANAG 1241](#))

4 GENERAL REQUIREMENTS

4.1 Command and control symbols. The symbol sets encompass the graphic representation of units, equipment, installations and other elements and activities relevant to joint military operations. They contain the building blocks for joint symbols from the air, land, maritime (sea surface and subsurface) and space physical domains.

4.2 Other symbols. This standard also contains standardized symbols and figures for control measures, meteorological and oceanographic (METOC), signals intelligence (SIGINT) and activities.

4.3 Joint military symbology sets. [Figure 1](#) shows the joint military symbology sets available for planning and conducting joint operations.

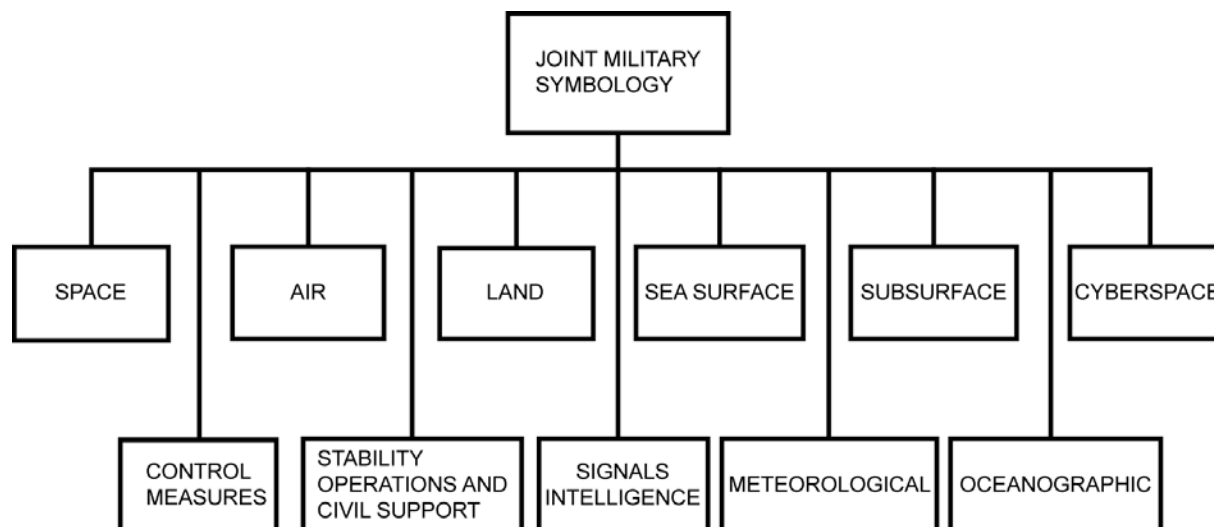

FIGURE 1. Joint military symbolology sets.

4.4 Monochromatic and hand-drawn symbols. While the focus of this publication is the display of symbols in modern multi-chromatic electronic systems, all symbols should be usable in monochromatic systems and as hand-drawn symbols.

4.5 Symbol recognition and legibility. When engineering and designing symbols and composing their building blocks, consider human factors; such as, symbol recognition and legibility across a variety of illumination conditions, map backgrounds, symbol sizes, display types and resolutions, and mental and physical fatigue.

5 DETAILED REQUIREMENTS

5.1 Objective. To promote interoperability at the information level within the area of joint military symbolology, it is necessary to define a standard set of rules for symbol construction and generation to be implemented in C2 systems. The rules in this standard are considered to be the minimum necessary to ensure that information about joint military symbolology is exchanged successfully across service and organizational boundaries. These rules are not intended to constrain the manner in which the symbolology is used.

5.2 Organization. This section provides the detailed requirements concerning the composition, construction, display and transmission of tactical symbols and control measure symbols considered essential to achieve interoperability. Display rules are provided which allow the degree of complexity of the resulting symbolology to be tailored to operational requirements and system capabilities. Additional implementation guidance is provided in each appendix as it applies to the particular symbolology set.

5.3 Icon-based symbols. Icon-based symbols represent units, equipment, installations, activities and meteorological occurrences. An icon-based symbol can be composed of a frame, fill, icon, modifiers and amplifiers (see figure 2). These elements are located within and around a virtual bounding octagon. The components of an icon-based symbol provide information about the standard identity, battle dimension, status and mission of an operational object. The

placement and display options of the various elements are explained in the following paragraphs. When representing unorthodox platforms, select the most appropriate icon from the standard.

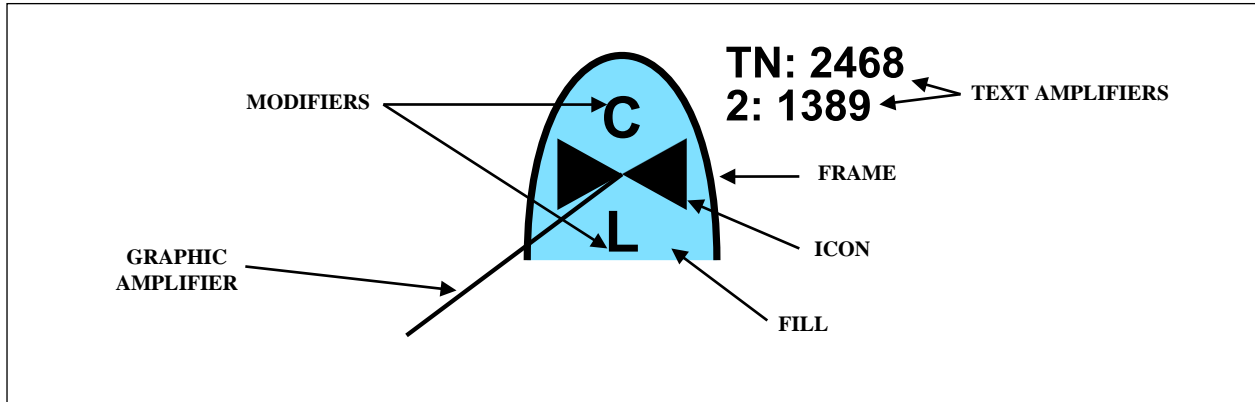

FIGURE 2. Icon-based symbol components.

5.3.1 Bounding octagon. The bounding octagon serves as the spatial reference for the relative sizing and placement of frames, icons and modifiers. The default length and height of the bounding octagon is L (see figure 3). L is measured from point to opposite point in the octagon. The bounding octagon shall not be displayed in a symbol. The bounding octagon appears in example symbols throughout this document for clarification purposes only.

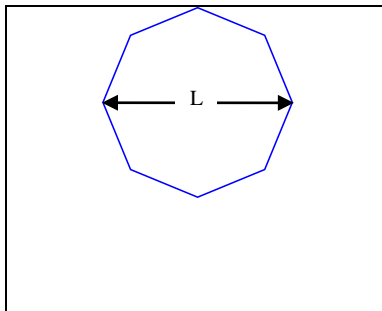

FIGURE 3. The bounding octagon.

5.3.1.1 Bounding octagon and frames. The size and placement of frames shall be determined by the size of the bounding octagon. Frame length and height shall vary from 1L to 1.5L depending on the particular frame. See figure 4 for sizing requirements of the basic frames relative to the bounding octagon. See 5.3.2 for more information on frames.

SPACE	AIR	LAND UNITS AND INSTALLATIONS	LAND EQUIPMENT AND SEA SURFACE	SUBSURFACE	ACTIVITY/EVENT

FIGURE 4. The bounding octagon and frame sizes.

5.3.1.2 The bounding octagon and icons/modifiers. The bounding octagon is divided into three horizontal sectors (main, 1 and 2) to specify positioning and sizing of icons and modifiers. Icons shall be placed in the main sector while modifiers are placed in sectors 1 and 2. Specific icons/symbols, as identified in the standard, require the sectored bounding octagon to be rotated 90 degrees counterclockwise to create vertical sectors. [Figure 5](#) shows the horizontal and vertical sectored bounding octagons. Icons shall not exceed the dimensions of the main sector of the bounding octagon or touch the interior border of the frame. To optimize legibility, icons may be enlarged within the constraints of the bounding octagon when one or no modifiers are displayed. The dimensions of unframed icons shall be the same as framed icons. [See 5.3.4](#) for more information on icons. Modifiers shall not exceed the dimensions of sectors 1 and 2. [See 5.3.5](#) for more information on modifiers.

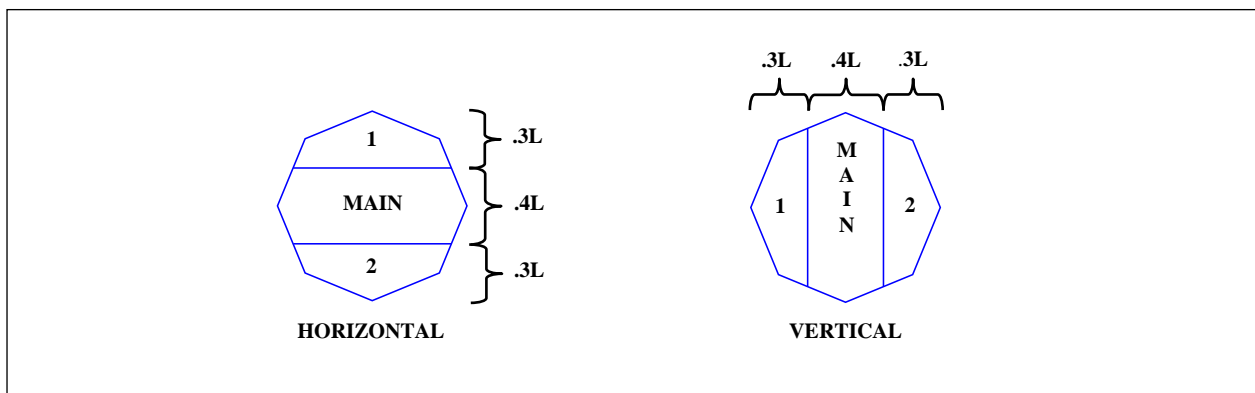

FIGURE 5. The bounding octagon with horizontal and vertical sectors.

5.3.2 Frame. The frame is the border of a symbol. A frame shall be optionally depicted in only two cases: land equipment and sea surface civilian vessels. Natural event symbols are unframed. When a frame is included in a symbol, its shape indicates the standard identity, dimension and status of the object. A frame can be black or white depending on display background. When the symbol is unfilled, the frame should be depicted using the default colors as specified in [5.5](#) to provide enhanced presentation information about standard identity. [Table I](#) provides the frame shapes that shall be used during real-world, non-exercise situations. [Table II](#) provides the frame shapes that shall be used during exercises. [Table III](#) provides the frame shapes that shall be used during simulations. If training tracks are displayed, they shall be identified by adding “-T” to the “X” in the exercise frame ([see figure 6](#)).

TABLE I. Frames depicting standard identities and dimensions.

DIMENSION STANDARD IDENTITY	DIMENSION							
	UNKNOWN	SPACE	AIR	LAND UNIT	LAND EQUIPMENT AND SEA SURFACE	LAND INSTALLATION	SUBSURFACE	ACTIVITY/ EVENT
PENDING (YELLOW)								
UNKNOWN (YELLOW)								
FRIEND (CYAN)								
NEUTRAL (GREEN)								
HOSTILE (RED)								
ASSUMED FRIEND (CYAN)								
SUSPECT (RED)								

Note: Frames displayed with solid lines or alternating black and white dotted lines, as shown above, indicate status as present, i.e., the object exists at the location identified. See table IV for examples of frames depicting planned or anticipated status.

TABLE II. Exercise frames.

DIMENSION STANDARD IDENTITY	DIMENSION							
	UNKNOWN	SPACE	AIR	LAND UNIT	LAND EQUIPMENT AND SEA SURFACE	LAND INSTALLATION	SUBSURFACE	ACTIVITY/ EVENT
EXERCISE PENDING (YELLOW)								
EXERCISE UNKNOWN (YELLOW)								
EXERCISE FRIEND (CYAN)	N/A							
EXERCISE NEUTRAL (GREEN)	N/A							
EXERCISE ASSUMED FRIEND (CYAN)	N/A							
JOKER (RED)	N/A							
FAKER (RED)	N/A							

Note: Frames displayed with solid lines or alternating black and white dotted lines, as shown above, indicate status as present, i.e., the object exists at the location identified. See table IV for examples of frames depicting planned or anticipated status.

TABLE III. Simulation frames.

DIMENSION STANDARD IDENTITY	DIMENSION							
	UNKNOWN	SPACE	AIR	LAND UNIT	LAND EQUIPMENT AND SEA SURFACE	LAND INSTALLATION	SUBSURFACE	ACTIVITY/ EVENT
SIMULATED PENDING (YELLOW)								
SIMULATED UNKNOWN (YELLOW)								
SIMULATED FRIEND (CYAN)								
SIMULATED NEUTRAL (GREEN)								
SIMULATED HOSTILE (RED)								
SIMULATED ASSUMED FRIEND (CYAN)								
SIMULATED SUSPECT (RED)								

Note: Frames displayed with solid lines or alternating black and white dotted lines, as shown above, indicate status as present, i.e., the object exists at the location identified. See table IV for examples of frames depicting planned or anticipated status.



FIGURE 6. Friend and neutral exercise training tracks.

5.3.2.1 Standard identity. The standard identities are unknown, assumed friend, friend, neutral, suspect and hostile. In addition, pending is a valid condition but not considered a standard identity. [Figure 7](#) shows assumed friend and suspect frames on various backgrounds.

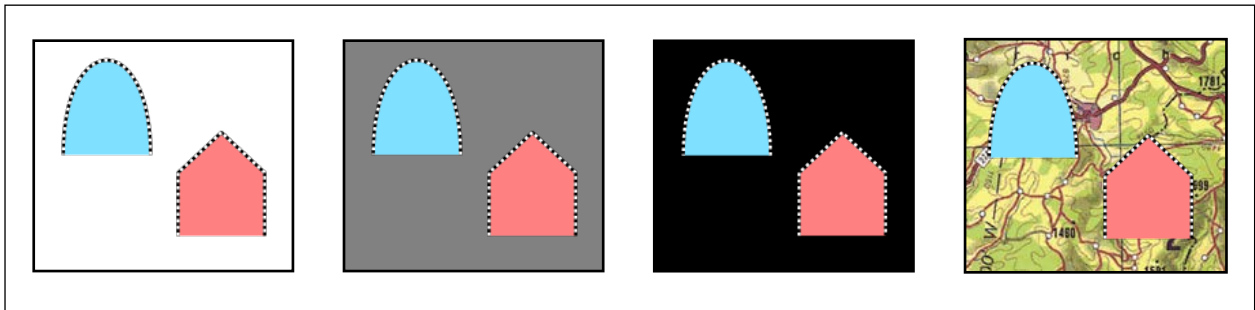

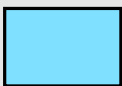



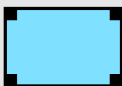

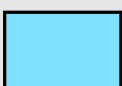





FIGURE 7. Assumed friend and suspect frames on various backgrounds.

5.3.2.2 Domain. The domains are air, land, sea, space and cyberspace. The air domain is above the surface of the earth to the exosphere. The land domain includes the ground and below its surface. The sea domain includes on and below the water's surface. The space domain is above the exosphere. The cyberspace domain is characterized by the use of electronics and the electromagnetic spectrum.

5.3.2.3 Status. Status depicts whether an object exists at the location identified (status is "present"), will in the future reside at that location (status is "planned" or "anticipated"), or is thought to reside at that location ("suspected"). The symbol frame will be a solid or black and white dotted line when indicating a present status and a dashed line when indicating anticipated, planned, or suspected status ([see table IV](#)). When the frame is assumed friend, suspect, or pending, the status will not be displayed.

TABLE IV. Friend frames shown in present and planned status.

DIMENSION STATUS	SPACE	AIR	LAND UNIT	LAND EQUIPMENT AND SEA SURFACE	LAND INSTALLATION	SUBSURFACE	ACTIVITY/ EVENT
PRESENT OR CONFIRMED POSITION							
ANTICIPATED, PLANNED OR SUSPECTED POSITION							

5.3.3 Fill. The fill is the interior area within a frame. In framed symbols, color shall provide a redundant indicator with regard to standard identity. If color is not used, the fill is transparent ([see figure 8](#)). In unframed symbols, color shall be the sole indicator of standard identity, excluding text amplifiers. The default colors that shall be used to designate standard identity when colored symbols are either hand drawn or displayed electronically are specified in [5.3](#). Table I depicts the default colors that shall be used to designate standard identity when colored symbols are either hand-drawn or displayed electronically. The color fill of purple ([see 5.3](#)) may be used as a rendering option for civilian units, equipment and installations. The standard identity shall determine the frame shape of the civilian track. The purple color fill option may be used for any or all of the domains and across all standard identities with the exception of suspect and hostile, which shall remain red. [Table V](#) depicts representative civilian tracks with purple fills. [See 5.5](#) for additional information on how color is to be displayed in a symbol.

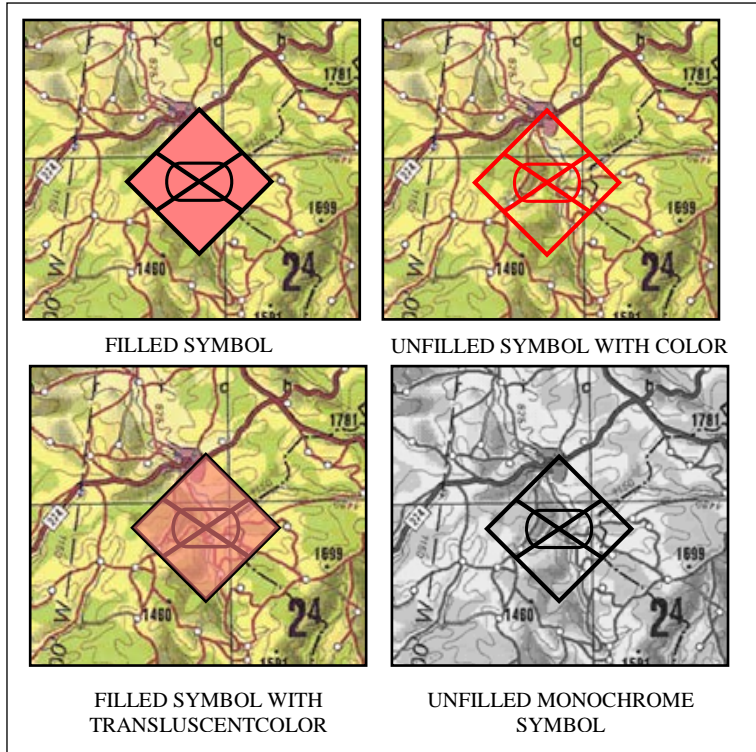

FIGURE 8. Examples of filled and unfilled symbols.





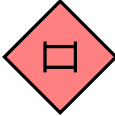

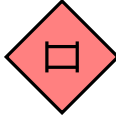

TABLE V. Civilian symbols with purple fill option.

STANDARD IDENTITY	AIR ¹	SEA SURFACE ²	LAND ³
FRIEND			
NEUTRAL			
UNKNOWN			
HOSTILE			

Notes: 1. Civilian fixed wing symbol shown.
 2. Civilian merchant ship shown.
 3. Civilian automobile shown.

5.3.4 Icons. The icon is the innermost part of a symbol which provides an abstract pictorial or alphanumeric representation of units, equipment, installations, activities, or operations. This standard distinguishes between icons that must be framed or unframed and icons where framing is optional. [See table VI](#) for examples of framed and unframed icons. Text icons shall be no more than four characters.

TABLE VI. Framed and unframed icons shown in present and planned status.

SYMBOL	FRAMED ICON (PRESENT)	UNFRAMED ICON (PRESENT)	FRAMED ICON (PLANNED)	UNFRAMED ICON (PLANNED)
FRIEND MORTAR				
HOSTILE TANK				

5.3.4.1 Main icons. Main icons are icons that are placed in the main sector of the bounding octagon and do not exceed the dimensions of the main sector ([see figure 9](#)).

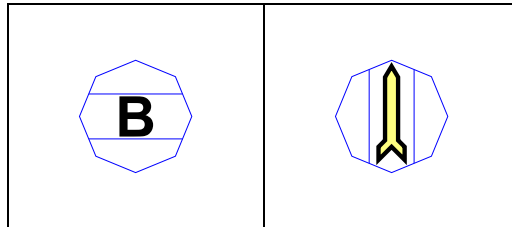

FIGURE 9. Examples of main icons.

5.3.4.2 Full octagon icons. Full octagon icons are icons that do not adhere to the sectors of the bounding octagon and do not exceed the dimensions of the bounding octagon ([see figure 10](#)).

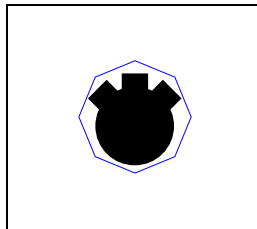

FIGURE 10. Example of full octagon icon.

5.3.4.3 Full frame icons. Full frame icons are icons that exceed the dimensions of the bounding octagon and touch the interior border of the frame ([see figure 11](#)).

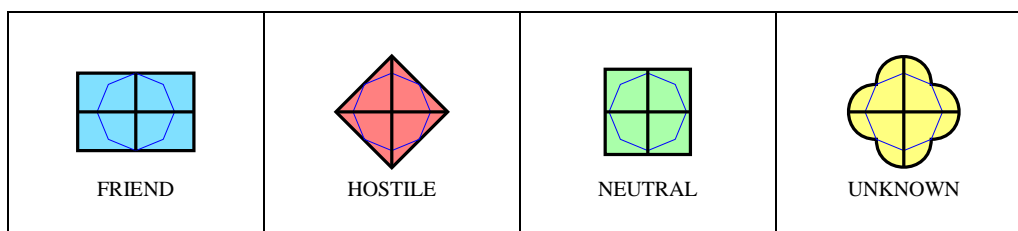

FIGURE 11. Examples of full frame icons (medical unit).

5.3.5 Modifiers. A modifier provides an abstract pictorial or alphanumeric representation that is displayed in conjunction with an icon inside the symbol frame or frame area when the frame is not shown. The modifier provides additional information about the object, such as unit, equipment, installation, or activity being displayed. Text modifiers shall be no more than three characters. A modifier may not be placed in any sector where the main icon extends into that particular sector of the bounding octagon.

5.3.6 Amplifiers. An amplifier provides additional information about the symbol and is displayed outside the frame. The amplifier field descriptions vary by dimension and are detailed within the respective appendices. The default placement of amplifiers around symbols is shown in each of the dimensions. Not all amplifiers are applicable to all symbols. When an amplifier is displayed, it shall be defined in accordance with the appropriate standard identity or control measure symbol. For the purposes of de-cluttering the display, only essential amplifiers should be used. When multiple text amplifiers are displayed in a single field, only the most critical amplifier should be used. Amplifiers on the left shall be right aligned, amplifiers on the right shall be left aligned and top and bottom amplifiers shall be centered. All text shall be presented in upper case sans serif font. Font size and color should be tested to determine display legibility. Amplifier fields should be used, even when not all amplifiers on a particular side of the symbol are displayed, and the order of the amplifier fields shall remain unchanged.

TABLE VII. Modifier and amplifier field definitions and maximum display lengths for tactical symbols.

FIELD	FIELD TITLE	DESCRIPTION	U ¹	E ^{1/2}	I ¹	SI ¹	A ¹
A	Symbol Icon	The innermost part of a symbol that represents a joint military object (see 5.3.4).	G	G	G	G	G
B	Echelon	A graphic amplifier in a unit symbol that identifies command level (see 5.3.6.1 and table D-III).	G	-	-	-	G
C	Quantity	A text amplifier in an equipment symbol that identifies the number of items present.	-	9 ³	-	-	-
D	Task Force Indicator	A graphic amplifier that identifies a unit or activities symbol as a task force (see 5.3.6.3 and figure 13).	G	-	-	-	G
E	Frame Shape Modifier	A graphic modifier that displays affiliation, battle dimension, or exercise amplifying descriptors of an object (see 5.3.2 and tables I, II and III).	G	G	G	-	G

TABLE VII. Modifier and amplifier field definitions and maximum display lengths for tactical symbols - Continued.

FIELD	FIELD TITLE	DESCRIPTION	U ¹	E ^{1/2}	I ¹	SI ¹	A ¹
F	Reinforced or Reduced	A text amplifier in a unit symbol that displays (+) for reinforced, (-) for reduced, (±) reinforced and reduced.	3	-	-	-	3
G	Staff Comments	A text amplifier for units, equipment and installations; content is implementation specific.	20	20	20	20	20
H	Additional Information	A text amplifier for units, equipment and installations; content is implementation specific.	20	20	20	20	20
J ⁴	Evaluation Rating	A text amplifier for units, equipment and installations that consists of a one-letter reliability rating and a one-number credibility rating: Reliability Ratings: A-completely reliable B-usually reliable C-fairly reliable D-not usually reliable E-unreliable F-reliability cannot be judged Credibility Ratings: 1-confirmed by other sources 2-probably true 3-possibly true 4-doubtfully true 5-improbable 6-truth cannot be judged.	2	2	2	2	2
K	Combat Effectiveness	A text amplifier for units and installations that indicates unit effectiveness or installation capability.	5	--	5	--	3
L	Signature Equipment	A text amplifier for hostile equipment; "!" indicates detectable electronic signatures.	-	1	-	1	-
M	Higher Formation	A text amplifier for units that indicates number or title of higher echelon command (corps are designated by Roman numerals).	21	-	-	21	-
N	Hostile (Enemy)	A text amplifier for equipment; letters "ENY" denote hostile symbols.	-	3	-	-	-
P	IFF/SIF/AIS	A text amplifier displaying IFF/SIF/AIS Identification modes and codes.	15	15	15	-	15
Q	Direction of Movement Indicator	A graphic amplifier for units and equipment that identifies the direction of movement or intended movement of an object (see 5.3.6.8 and figure 13).	G	G	G	-	G
R	Mobility Indicator	A graphic amplifier for equipment that depicts the mobility of an object (see 5.3.6.9 , figure 13 and table VIII).	-	G	-	-	-

TABLE VII. Modifier and amplifier field definitions and maximum display lengths for tactical symbols - Continued.

FIELD	FIELD TITLE	DESCRIPTION	U ¹	E ^{1/2}	I ¹	SI ¹	A ¹
R2	SIGINT Mobility Indicator	M = Mobile, S = Static, or U = Uncertain.	-	-	-	1	-
S	Headquarters Staff Indicator/Offset Location Indicator	Headquarters staff indicator: A graphic amplifier for units, equipment and installations that identifies a unit as a headquarters (see table D-III and figure 13). Offset location indicator: A graphic amplifier for units, equipment and installations used when placing an object away from its actual location (see 5.3.6.5 and figure 13).	G	G	G	-	G
T	Unique Designation	A text amplifier for units, equipment and installations that uniquely identifies a particular symbol or track number. Identifies acquisitions number when used with SIGINT symbology.	30	30	30	30	30
V	Type	A text amplifier for equipment that indicates types of equipment.	-	24	-	24	-
W ⁵	Date/Time Group (DTG)	An alphanumeric designator for displaying a date-time group (DDHHMMSSZMONYYYY) or "O/O" for on order. The date-time group is composed of a group of six numeric digits with a time zone suffix and the standardized three-letter abbreviation for the month followed by four digits representing the year. The first pair of digits represents the day; the second pair, the hour; the third pair, the minutes. For automated systems, two digits may be added before the time zone suffix and after the minutes to designate seconds.	16	16	16	16	16
X	Altitude/Depth	A text amplifier for units, equipment and installations, that displays either altitude, flight level, depth for submerged objects; or height of equipment or structures on the ground. See 5.3.6.6 for content.	14	14	14	-	14
Y ⁶	Location	A text amplifier for units, equipment and installations that displays a symbol's location in degrees, minutes and decimal minutes (or in MGRS or other applicable display format).	19	19	19	19	19
Z	Speed	A text amplifier for units and equipment that displays velocity as set forth in MIL-STD-6040 .	8	8	8	-	8

TABLE VII. Modifier and amplifier field definitions and maximum display lengths for tactical symbols - Continued.

FIELD	FIELD TITLE	DESCRIPTION	U ¹	E ^{1/2}	I ¹	SI ¹	A ¹
AA	Special C ² Headquarters	A text modifier for units; indicator is contained inside the frame; contains the name of the special C2 Headquarters.	9	-	-	-	9
AB	Feint/Dummy Indicator	A graphic amplifier for units, equipment and installations that identifies an offensive or defensive unit intended to draw the enemy's attention away from the area of the main attack (see 5.3.6.4 and figure 13).	G	G	G	-	G
AC	Installation	Installation: A graphic amplifier for units, equipment and installations used to show that a particular symbol denotes an installation (see 5.3.6.2 and figure 13).	G	G	G	-	G
AD	Platform Type	Electronic intelligence notation (ELNOT) or communications intelligence notation (CENOT)	-	-	-	6	-
AE	Equipment Teardown Time	Equipment teardown time in minutes.	-	-	-	3	-
AF	Common Identifier	Example: "Hawk" for Hawk SAM system.	-	-	-	12	-
AG	Auxiliary Equipment Indicator	Towed sonar array indicator: A graphic modifier for equipment that indicates the presence of a towed sonar array (see 5.3.6.10 , figure 13 and table IX).	-	G	-	-	-
AH	Area of Uncertainty	A graphic modifier for units, equipment and installations that indicates the area where an object is most likely to be, based on the object's last report and the reporting accuracy of the sensor that detected the object (see 5.3.6.12.1 and table D-III).	G	G	G	-	G
AI	Dead Reckoning Trailer	A graphic amplifier for units and equipment that identifies where an object should be located at present, given its last reported course and speed (see 5.3.6.12.2 and table D-III).	G	G	G	-	G
AJ	Speed Leader	A graphic amplifier for units, equipment and installations that depicts the speed and direction of movement of an object (see 5.3.6.12.3 and table D-III).	G	G	G	-	G
AK	Pairing Line	A graphic amplifier for units, equipment and installations that connects two objects and is updated dynamically as the positions of the objects change (see 5.3.6.12.4 and table D-III).	G	G	G	-	G
AL	Operational Condition	A graphic amplifier for equipment or installations that indicates operational condition or capacity.		G	G		G

TABLE VII. Modifier and amplifier field definitions and maximum display lengths for tactical symbols - Continued.

FIELD	FIELD TITLE	DESCRIPTION	U ¹	E ^{1/2}	I ¹	SI ¹	A ¹
AO	Engagement Bar	A graphic amplifier placed immediately atop the symbol. May denote, 1) local/remote status; 2) engagement status; and 3) weapon type.	G/8	G/8	G/8	-	-
AP	Target Designator	A six character text modifier used in Fire Support operations to uniquely designate targets in accordance with STANAG 2147, where characters 1 and 2 are alphabetic, and characters 3-6 are numeric: AANNNN.	-	3	-	-	-
AQ	Guarded Unit	During ballistic missile defense, some tracks are designated as guarded by a particular unit	-	2	-	-	-
AR	Special Designator	Special track designators such as Non-Real Time (NRT) and Tactically Significant (SIG) tracks are denoted here.	-	3	-	-	-
AS	Country	Identifies the country of the organization being shown. Use GENC Standard	3	-	-	-	G

- Notes:** 1. Column headings: U = units, E = equipment, I= installations, SI = signals intelligence (SIGINT) and A = Activities.
2. Equipment includes air, space, sea surface, subsurface and SOF, as well as land-based equipment as shown in table I.
3. Numeric entry indicates text modifier. "G" indicates graphic modifier. A dash (-) inside boxes indicates non-applicable.
4. Field J: See TC 2-33.4.
5. Field W: D = day, H = hour, M = minute, S = second, Z = Greenwich or local time, MON= month and Y = year.
6. To support homeland security and homeland defense, the Federal Geographic Data Committee (FGDC) US National Grid (USNG) standard when referenced to North American Datum 1983 (NAD83) is operationally equivalent to and is an accepted substitute for MGRS coordinates referenced to WGS 84. Note that at mapping scales of 1:5000 and smaller, NAD83 and WGS 84 are considered equivalent.

5.3.6.1 Echelon indicator. The echelon indicator provides a graphic representation of command level and is used to show the element echelon on installations, boundary lines, lines and areas. Echelon indicator codes are listed in [table D-III](#) of the land appendix. The indicator is represented in field B as defined in [table VII](#).

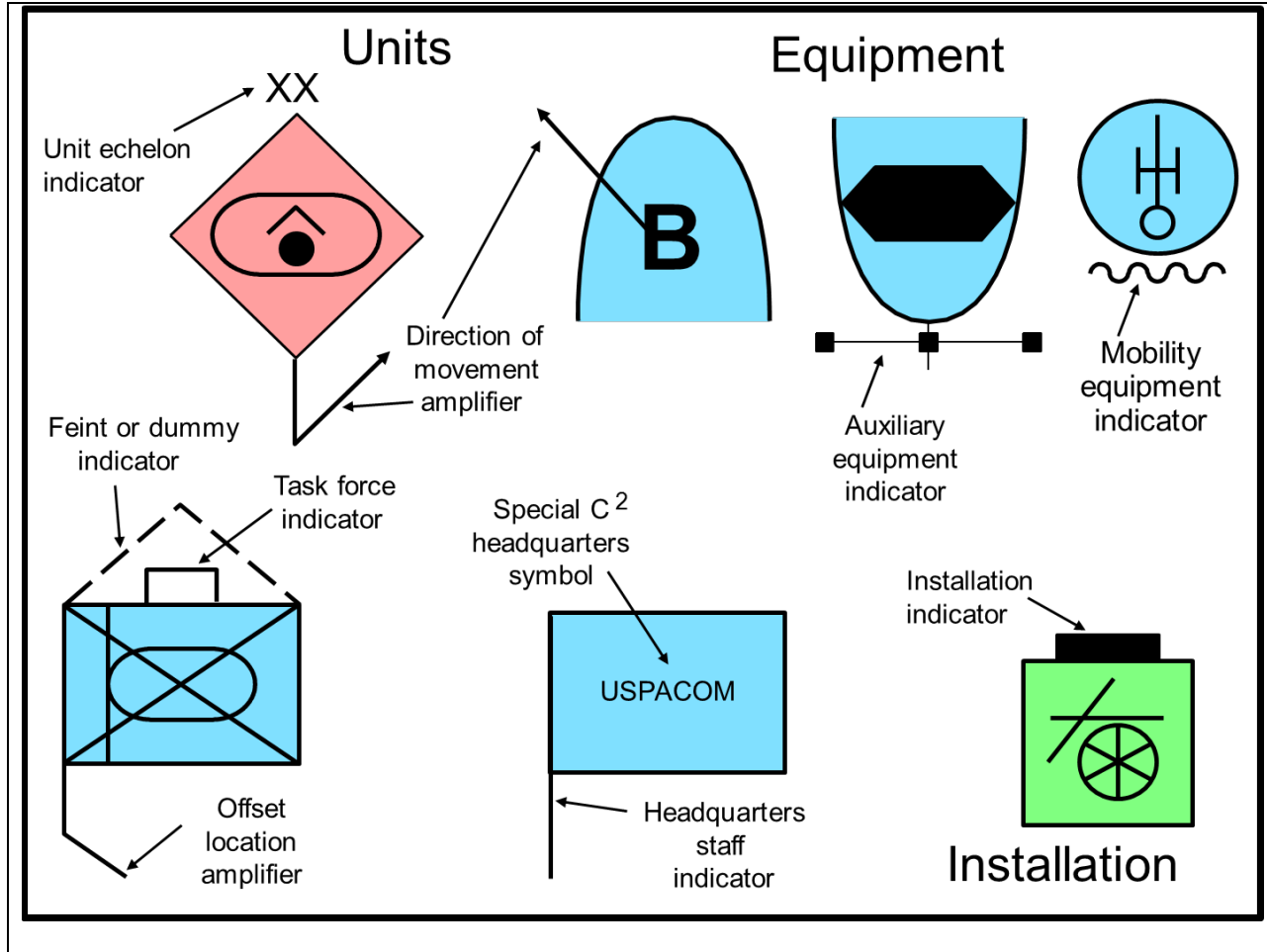

FIGURE 12. Static graphic modifiers for tactical symbols.

5.3.6.2 Installation indicator. The installation indicator is a shaded block used to show that a particular symbol denotes an installation. Although installations are included in the symbol hierarchy, the addition of an installation indicator can turn any tactical symbol (except Signals Intelligence symbology - Appendix J) into an installation. The indicator is represented in field AC as defined in [table VII](#) and is positioned as shown in [figure 12](#).

5.3.6.3 Task force indicator. The task force indicator is a bracket that identifies a unit or activities symbol as a task force. The indicator is represented in field D as defined in [table VII](#) and is positioned as shown in [figure 12](#).

5.3.6.4 Feint/dummy indicator. The feint or dummy indicator is a dashed inverted “V” that identifies offensive or defensive units, equipment and installations intended to draw the enemy's attention away from the area of the main attack. The indicator is represented in field AB as defined in [table VII](#) and is positioned as shown in [figure 12](#).

5.3.6.5 Offset location amplifier. The offset location amplifier is used when placing an object away from its actual location. The amplifier is a line extending downward from the left side of a frame or an appropriate anchor point on an icon. The offset location amplifier differs

from the headquarters staff amplifier in that the former has an elbow extending to the actual location. [See figure 12](#). In addition, the actual location is given in latitude and longitude.

5.3.6.6 Altitude/depth modifier. This field may contain alternate value formats. Enter a description of the altitude/depth (X) using one of the following.

5.3.6.6.1 Altitude base reference point. Legal values are “GL” ground level and “MSL” mean sea level.

5.3.6.6.2 Relative altitude. The relative altitude is a composite field consisting of multiple parts: the numeric altitude, the altitude unit of measurement and the altitude vertical dimension. Legal values for the numeric altitude are (minus) -99999 through 99999 in increments of 1. Legal values for altitude units of measure is feet “FT,” meters “M,” kilometers “KM,” and statute miles “SM.” The legal value for the depth unit of measure is feet “FT” and meters “M.” Legal values for the vertical dimension are “AGL” above ground level, “AMSL” above mean sea level, “HAE” height above ellipsoid and “BMSL” below mean sea level. BMSL is used only for depth of submerged objects, reported in feet. A space may be added between the values in the field to make it easier to read.

Examples: 1250 FT AGL, 1000 FT AMSL, 1524 M HAE, 35760 FT BMSL.

5.3.6.6.3 Flight level. By definition, flight level (FL) is, “Surfaces of constant atmospheric pressure which are related to a specific pressure datum, 1013.2 mb (29.92 in) and are separated by specific pressure intervals. (Flight levels are expressed in three digits that represent hundreds of feet; e.g., flight level 250 represents a barometric altimeter indication of 25,000 feet and flight level 255 is an indication of 25,500 feet.)” The legal value for flight level indicator is “FL.” A space may be added between the values in the field to make it easier to read. The legal value for context quantity is 000-999, in increments of one.

Example: FL 290.

5.3.6.6.4 Multiple instances of altitude/depth modifiers. When multiple instances of the “X” modifier are present in a single instance of a symbol or graphic (ex., Minimum Altitude “X,” Maximum Altitude “X1”), for display purposes, the fields may be separated by a hyphen “-,” or a space, hyphen and space “ - .”

Examples:

500 FT AGL – 1250 FT AGL

25 FT AMSL –
150 FT AMSL

FL 250 – FL 290

MSL –
35760 FT BMSL

5.3.6.7 Date-time group. Date-time group (DTG) is defined as the date and time expressed in an alphanumeric combination. The alphanumeric combination used is day-time-time zone-month-year. The alphanumeric combination can be displayed in a number of ways. In its longest form, sixteen characters, it is composed of eight digits (first pair of digits denotes the date, second pair denotes the hours, third pair denotes the minutes and fourth pair denotes the seconds) followed by the time zone suffix, followed by a three-letter month abbreviation and four digits for the year: DDHHMMSSZMONYYYY. It can also be expressed in shorter forms by removing characters, such as DDHHMMZMONYY. On order (O/O) is a valid substitute for DTG.

5.3.6.8 Direction of movement amplifier. The direction of movement amplifier is an arrow or staff identifying the direction of movement or intended movement of an object. For land symbols, the amplifier is an angled arrow extending downward from the bottom center of the frame or icon and pointing in the direction of movement. For all other symbols, the amplifier is an arrow extending from the center of the frame or icon and pointing in the direction of movement (see figure 12).

5.3.6.9 Mobility indicator. The mobility indicator, which is only used for equipment, depicts the mobility feature of an object, as shown in table VIII. This indicator identifies mobility other than that intrinsic to the equipment itself. For example, the symbol for a self-propelled howitzer moving by train would include a railway mobility indicator, while the symbol for a self-propelled howitzer, a tank or other tracked vehicle would not have a mobility indicator. The indicator is represented in field R as defined in table VII and is positioned as shown in figure 12.

TABLE VIII. Equipment mobility indicators.













DESCRIPTION	MOBILITY SYMBOL	UNFRAMED	UNKNOWN	FRIEND	NEUTRAL	HOSTILE
WHEELED (LIMITED CROSS-COUNTRY)						
WHEELED (CROSS-COUNTRY)						
TRACKED						
WHEELED AND TRACKED COMBINATION						

TABLE VIII. Equipment mobility indicators - Continued.

DESCRIPTION	MOBILITY SYMBOL	UNFRAMED	UNKNOWN	FRIEND	NEUTRAL	HOSTILE
TOWED						
RAILWAY						
OVER-SNOW (PRIME MOVER)						
SLED						
PACK ANIMALS						
BARGE						
AMPHIBIOUS						

5.3.6.10 Auxiliary equipment indicator. The auxiliary equipment indicator, which is only used for towed equipment, depicts the mobility feature of an array, as shown in [table IX](#). The indicator is represented in field AG as defined in [table VII](#) and is positioned as shown in [figure 12](#).

TABLE IX. Auxiliary equipment indicators.

DESCRIPTION	MOBILITY SYMBOL	UNFRAMED	UNKNOWN	FRIEND	NEUTRAL	HOSTILE
TOWED SONAR ARRAY (SHORT)						
TOWED SONAR ARRAY (LONG)						

5.3.6.11 Text modifiers. Table IV defines the specific content, length and type of each text modifier. Not all text modifiers are applicable to all symbols. However, when any such modifier is displayed, it shall be defined in accordance with the contents of [table VII](#) and positioned in accordance with [figure 12](#). Air/space and sea track numbers are included in field T. Staff comments and additional information are contained in fields G and H, with the content of these fields being implementation specific so long as the maximum number of characters in each field is not exceeded. Although text modifiers are normally displayed around the symbol, the special C2 headquarters indicator (field AA as defined in [table VII](#)) is contained inside the frame, as seen in [figure 2](#) and [figure 12](#).

5.3.6.12 Dynamic graphic amplifiers. A dynamic amplifier is a line or area graphic whose size and placement are based on the attributes of the object represented by the symbol and can change as these attributes and the scale of the background change. An example of each dynamic graphic amplifier is shown in [figure 13](#). These examples are notional; the size and placement of each amplifier will vary based on the attributes of the object.

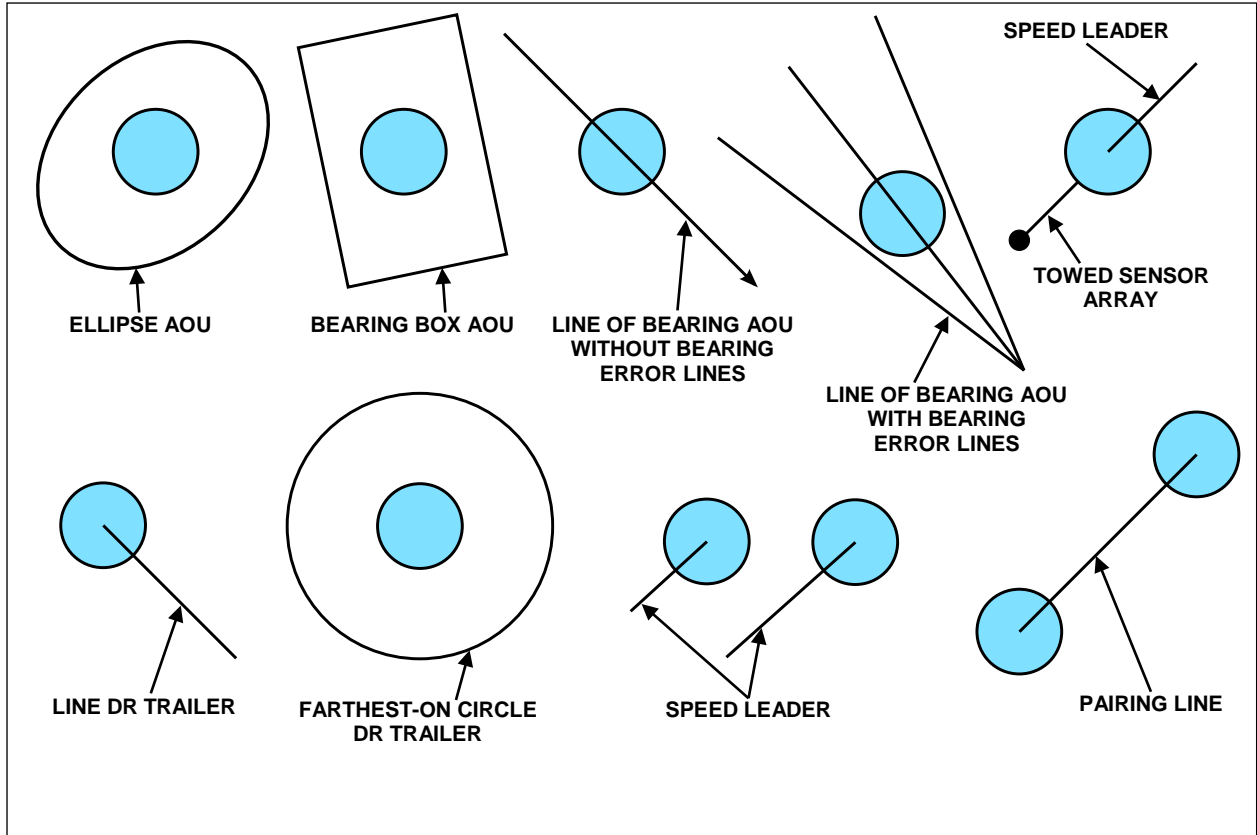

FIGURE 13. Dynamic graphic amplifiers for icon-based symbols.

Dynamic graphic amplifiers may be color-coded based on the attributes of the symbol. In cases such as ballistic missile target status as indicated in the Engagement/Target Bar (field AL), the symbol's track history, projected trajectory (similar to dead reckoning), threat fan and its projected impact ellipse should reflect target status of the ballistic missile. Likewise, if threat is denoted by color via the Operational Condition/Status bar (field AO), symbols associated amplifier graphics should reflect the color status indicated in the operational condition/status field. [Figure 14](#) illustrates an example of dynamic amplifiers being color coded.

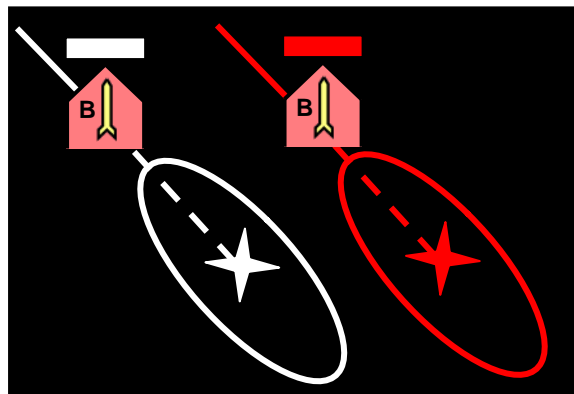

FIGURE 14. Color coded dynamic amplifiers

5.3.6.12.1 Area of uncertainty amplifier. The area of uncertainty (AOU) amplifier displays the area where an object is most likely to be located, based on the object's last report and the reporting accuracy of the sensor that detected the object. The AOU amplifier can be displayed as an ellipse, a bearing box, or a line of bearing, depending on the report received for the object.

5.3.6.12.1.1 Ellipse AOU amplifier. The ellipse AOU amplifier is a rotated ellipse whose center is the last reported position for the object. The ellipse is shown as a solid line whose draw parameters are based on the attributes of the sensor that detected the object. The symbol for the object is displayed at the center of the ellipse.

5.3.6.12.1.2 Bearing box AOU amplifier. The bearing box AOU amplifier is a rotated rectangle whose center is the last reported position for the object. The rectangle is shown as a solid line whose draw parameters are based on the attributes of the sensor that detected the object. The symbol for the object is displayed at the center of the box.

5.3.6.12.1.3 Line of bearing AOU amplifier. The line of bearing AOU amplifier is a solid line whose rotation represents the bearing of the object and whose length is determined by its range estimate. The amplifier has a single bearing "center" line and may include bearing error "V" lines. The bearing error determines the placement of the "V" lines and is the angle from the bearing line to one of the bearing error lines. The bearing error lines are dotted and symmetric on either side of the bearing line. The length of the bearing error lines is equal to the bearing length.

5.3.6.12.2 Dead reckoning trailer amplifier. An object can be displayed at its last reported position, or it can be displayed at its dead reckoned position. Dead reckoning (DR) uses the course and speed of an object from the last report and calculates where the object should be at present. The object is then plotted where it should be at the present time, assuming the course and speed are unchanged. The DR trailer amplifier can be displayed as a line or circle, depending on the report received for the object. Because DR calculates where the object should be at present, the status of the symbol for the object is shown as "present," rather than "planned."

5.3.6.12.2.1 Line DR trailer amplifier. The line DR trailer amplifier is a dotted line that extends from the last reported position for the object to its dead reckoned position. The dotted line is a series of uniformly sized and shaped dots, with the symbol for the object displayed at its dead reckoned position.

5.3.6.12.2.2 Farthest-on circle DR trailer amplifier. The farthest-on circle DR trailer amplifier is a dotted circle indicating the furthest an object could be after a given time traveling at its top speed in any direction. The center of the circle is the last reported position for the object, and the radius is the maximum distance the object could travel based on its last reported position and speed; the symbol for the object is displayed at the center of the circle.

5.3.6.12.3 Speed leader amplifier. The speed leader amplifier is a line extending from the center of the frame or icon and pointing in the direction of movement; the length of the line is based on a combination of actual speed and object type. For example, the length of the speed leader for a submarine might be 1/4 inch if its speed is less than 15 knots, 1/2 inch if its speed is between 15 and 30 knots and 3/4 inch if its speed is more than 30 knots, while the length of the

speed leader for an aircraft might be 1/4 inch if its speed is less than 300 knots, 1/2 inch if its speed is between 300 and 600 knots and 3/4 inch if its speed is more than 600 knots. The speed leader represents both speed and direction of movement information in a single amplifier; by contrast, the static direction of movement amplifier is a fixed length and identifies only the direction of movement of the object.

5.3.6.12.4 Pairing line amplifier. The pairing line amplifier is a line that connects two objects and is updated dynamically as the positions of the two objects change. For example, a pairing line might connect an active missile to the associated hostile aircraft. A pairing line is drawn from the center of the frame or icon for the first object to the center of the frame or icon for the second object. The color and style (e.g., solid, dotted) of the line can vary based on the specific context in which the amplifier is used.

5.3.6.12.5 Dynamic towed sensor array amplifier. The dynamic towed sensor array amplifier is a line extending from the center of a symbol to the center of towed acoustic array. The length of the line is based upon the distance between the stern of the towing ship and the center of the towed acoustic array. The orientation of the towed sensor array amplifier shall be 180 degrees from the speed leader of the object. A solid circle, representing the center of the acoustic array, shall be at the terminus of the towed sensor array amplifier.





5.3.6.13 Operational condition amplifier. The operational condition amplifier provides a graphic representation of an entity’s (equipment or installation) operational condition. Operational condition amplifiers are shown in [table VII](#) and defined in the appendix for each symbology set. An alternative color representation is shown in [table VIII](#).

TABLE X. Operational condition amplifiers for icon-based symbols.

OPER. CONDITION \ DIMENSION	AIR/SPACE	SURFACE				
		LAND			SEA SURFACE	SUBSURFACE
		UNITS	EQUIPMENT	INSTALLATIONS		
FULLY CAPABLE		N/A				
DAMAGED/RENDERED INEFFECTIVE ¹		N/A				
DESTROYED		N/A				

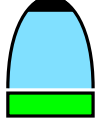
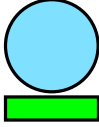
Notes: 1. The “Rendered Ineffective” operational condition amplifier shall be used when equipment capable of inflicting injury and/or death (IEDs or mines) is known to have been defused or rendered inoperable while under the control of friendly forces. The “Damaged” operational condition amplifier shall be used where “Rendered Ineffective” does not apply.

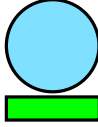
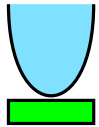
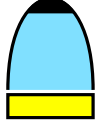
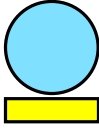
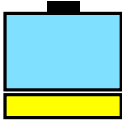
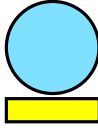
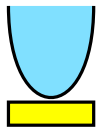
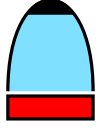
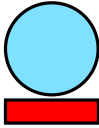
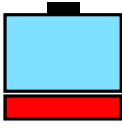
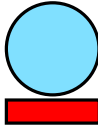
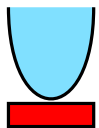
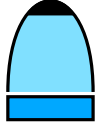
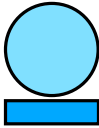
TABLE XI. Alternate operational condition amplifiers for icon-based symbols.

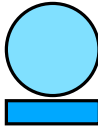
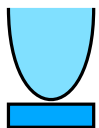
OPER. CONDITION	DIMENSION	AIR/SPACE	SURFACE				
			LAND			SEA SURFACE	SUBSURFACE
			UNITS	EQUIPMENT	INSTALLATIONS		
FULLY CAPABLE		N/A					
DAMAGED/RENDERED INEFFECTIVE ¹		N/A					
DESTROYED		N/A					
FULL TO CAPACITY ²		N/A					

Notes: 1. The “Rendered Ineffective” operational condition amplifier shall be used when equipment capable of inflicting injury and/or death (IEDs or mines) is known to have been defused or rendered inoperable while under the control of friendly forces. The “Damaged” operational condition amplifier shall be used where “Rendered Ineffective” does not apply.

2. Associated with a symbolized object where its capacity can be measured and the status of that capacity is relevant.

5.3.6.14 Engagement amplifier bar. The engagement amplifier bar may be used to designate engagements and/or to indicate targets. Both may be done in conjunction where depicted targets contain engagement information.

5.3.6.14.1 Engagement designation using the engagement amplifier bar. Engagement bars are positioned immediately atop the hostile target and its assigned friendly track. Example depictions of engagement bars are illustrated in [figure 15](#) and [figure 16](#).

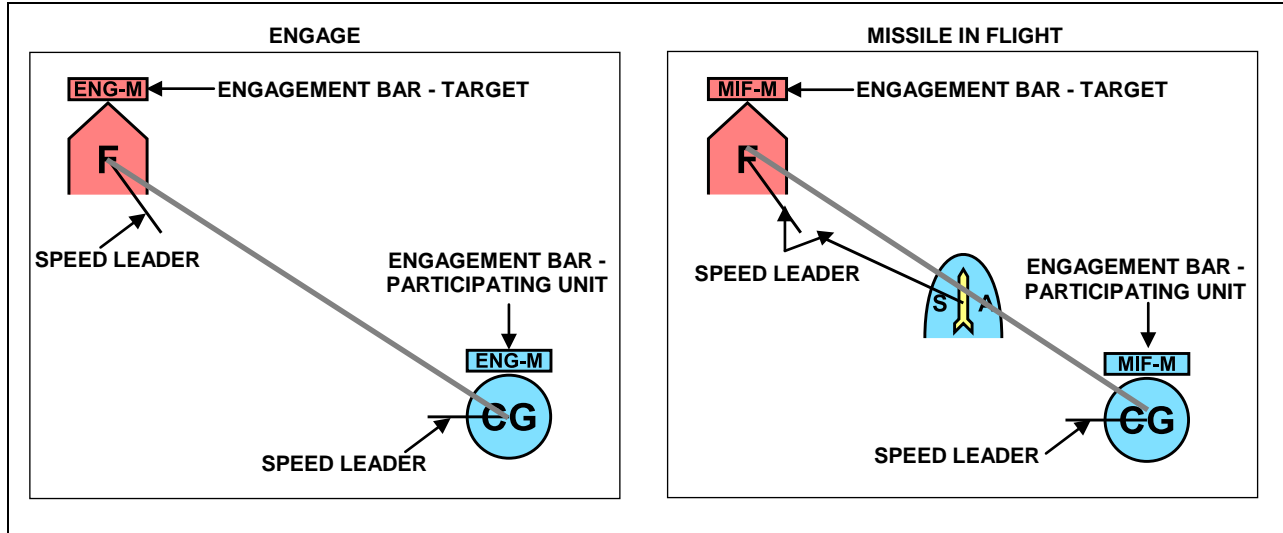

FIGURE 15. Example local engagement scenarios: engage (left), missile in flight (right).

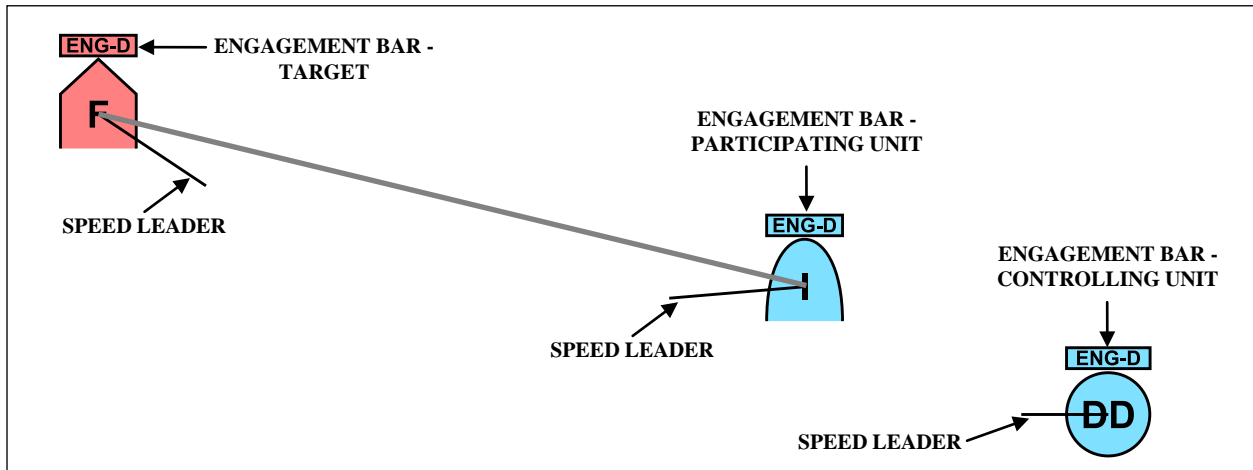

FIGURE 16. Example engagement scenario: participating units.

The engagement bar may contain information on 1) remote/local engagement; 2) stage of the engagement (i.e., assign/cover, engage, hold fire, cease fire, cease engagement, break engagement, missile in flight); and 3) type of weapon assignment (i.e., missile, gun, torpedo). The color of the engagement bar should be identical to its symbol's standard identity. Therefore, engagement bars for a hostile target and a friendly participating unit would have red and blue engagement bars, respectively (see [figure 17](#) and [figure 18](#)). The colors of the engagement bars should have the same RGB value as its respective symbol. All engagement bars should have a black or white frame based on providing optimal contrast between the colored amplifier bar and the map background.

5.3.6.14.2 Target designation using the engagement amplifier bar. If the engagement amplifier bar is used to designate targets, non-targets or expired targets, a different coloring schema shall be used. Hostile tracks which are deemed targets shall have a red bar (RGB: 255, 0, 0) to indicate target. For hostile tracks deemed to be non-targets, white

(RGB: 255, 255, 255) should be used to indicate non-target. Finally for hostile tracks which have expired shall be colored orange (RGB: 255, 120, 0). [Figure 17](#) depicts the three target denotations.

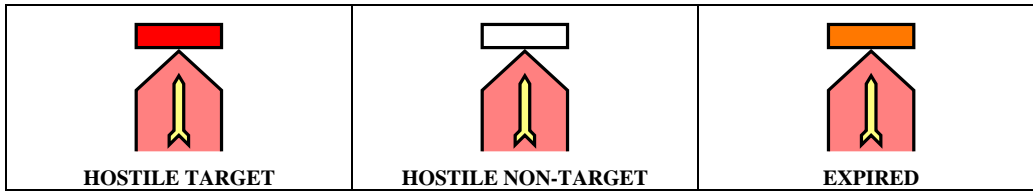

FIGURE 17. Engagement amplifier bar colors for target designation.

5.3.6.14.2.1 For hostile targets. If engagement text is incorporated, either white (RGB: 255, 255, 255) or black (RGB: 0, 0, 0) may be used to denote engagement status. Otherwise, for non-targets and expired tracks, engagement status within the engagement amplifier bars shall remain black (see [figure 18](#)).

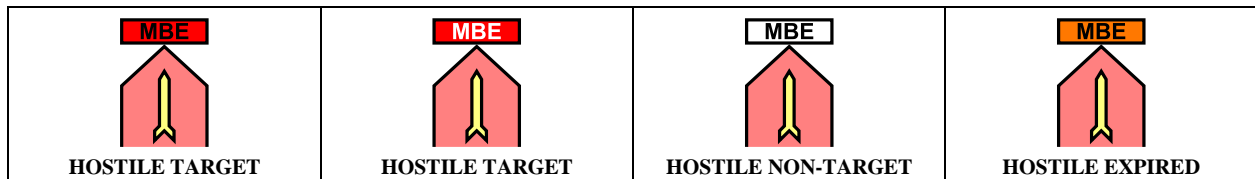

FIGURE 18. Engagement amplifier bar text colors for target designation.

5.3.6.14.3 Engagement amplifier bar structure. The engagement amplifier shall be arranged as follows: A:BBB-CC, where A (1 character) denotes a local versus remote engagement, BBB (up to 3 characters) denotes engagement state and CC (up to 2 characters) denotes weapon deployment/asset control.

5.3.6.14.3.1 Remote and local engagements. Remote and local engagements may be identified in the engagement amplifier (part A of A:BBB-CC). A remote engagement is defined as an engagement assigned outside of ownship control. A local engagement is defined as an engagement assigned to ownship. Local engagements shall have no letter assignment in the A:BBB-CC engagement bar; whereas, remote engagements shall be denoted as “R” in the engagement bar. In the case of multiple engagements, there may be a mixture of both local and remote engagements. In such cases, “B” shall be denoted to indicate both local and remote engagements and shall be used in conjunction with the multiple engagements amplifier (MLT).

5.3.6.14.3.2 Engagement stage. Engagement stage may be identified by up to a three-character code (part BBB of A:BBB-CC). Typical engagement stages to depict include assign/cover, engage and missile(s) in flight. Other engagement events such as hold fire, cease fire, cease engage, break engagement, terminate engagement, management by exception, management by exception less than threshold and others may be depicted in the engagement amplifier. In the case of multiple engagements where no one specific engagement is highlighted, “MLT” may be used to indicate multiple engagements. In conjunction with the MLT designation, the number of engagements shall be listed in the subsequent CC field (see 5.3.6.14.3.3). [Table XII](#) depicts engagement stage codes.

TABLE XII. Engagement¹ stage codes.

ENGAGEMENT STAGE	CODE
ASSIGN/COVER	ASN
ENGAGE	ENG
MISSILE IN FLIGHT	MIF
CEASE FIRE	CF
CEASE ENGAGE	CE
HOLD FIRE	HF
TERMINATE ENGAGEMENT	TE
BREAK ENGAGEMENT	BE
MANAGEMENT BY EXCEPTION (MBE)	MBE
MBE LESS THAN THRESHOLD	M<T
MULTIPLE ENGAGEMENTS ²	MLT

Notes: 1. The term "Engagement" as used in paragraph 5.1.6.14.3.2 denotes both air-to-air and air-to-ground/air-to-surface activities.
2. Number of engagements shall be represented in CC field (see 5.1.6.14.3.3).

5.3.6.14.3.3 Weapons assignment or deployment. Weapons assignment or deployment may also be presented in the engagement amplifier (part CC of A:BBB-CC). Either deployed weapons such as missiles, guns and torpedoes or controlled assets such as unmanned systems, interceptor aircraft and attack aircraft may have representation in the engagement bar. In the case where multiple engagements are represented within a single engagement amplifier bar, the number of engagements starting from "02" shall be used in the CC field. [Table XIII](#) depicts weapon and asset codes.

TABLE XIII. Weapon and asset codes.

WEAPON/ASSET	CODE
MISSILE	M
BALLISTIC MISSILE	BM
CRUISE MISSILE	CM
GUN	GN
TORPEDO	T
ATTACK AIRCRAFT	A
COMBAT AIR PATROL (DEFENSIVE COUNTER AIR)	C
DEFENSIVE COUNTER AIR (COMBAT AIR PATROL)	D
UNDERSEA WARFARE (USW)/ANTISUBMARINE WARFARE (ASW)ENGAGEMENT	UW
MINE WARFARE (MIW) ENGAGEMENT	MW
SURFACE WARFARE (SUW) ENGAGEMENT	SW

TABLE XIII. Weapon and asset codes - Continued.

WEAPON/ASSET	CODE
ELECTRONIC ATTACK	EA
ELECTRONIC DEFENSE	ED
UNMANNED VEHICLE	UV
CLOSE-IN WEAPON SYSTEM	CW
LAMPS	L3
VERTICAL LAUNCH ASROC ¹	VA
NUMBER OF ENGAGEMENTS ²	## (02-99)

Notes: 1. Some non-US ships still use non-vertical launch ASROC

2. Shall only be used in conjunction with multiple engagements. Valid numbers are 02-99.

5.3.7 Manually-generated tracks. Manually-generated tracks are those symbols which have not been received through messaging systems, such as Link 16, but rather have been created locally for display. Manually-generated (or manual) tracks are denoted by the “MAN” icon placed within the symbol. Manual tracks can be created across all standard identities and dimensions by adding the “MAN” icon to the center of the frame. In addition, manual tracks can be created for tracks with a known standard identity but unknown dimension by adding the “MAN” icon under the “?” icon. [See figure 19](#) for examples of manual tracks. Manual tracks are only local symbols and not transmitted.

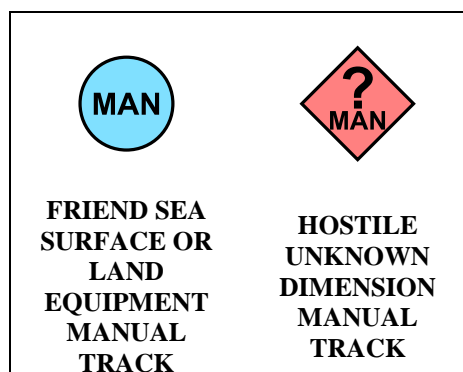
FIGURE 19. Manually-generated tracks.

5.3.8 Composition of icon-based symbols. The purpose of icon, modifier and amplifier placement is to standardize the location of information that graphically describes a unit, equipment, or installation and provides additional information on capability, status and location. [Figure 20](#) shows the composition and placement of a frame, fill, icon, modifiers and amplifiers to form a hostile land unit symbol. The placement of icons, modifiers and amplifiers is the same regardless of frame shape or standard identity.

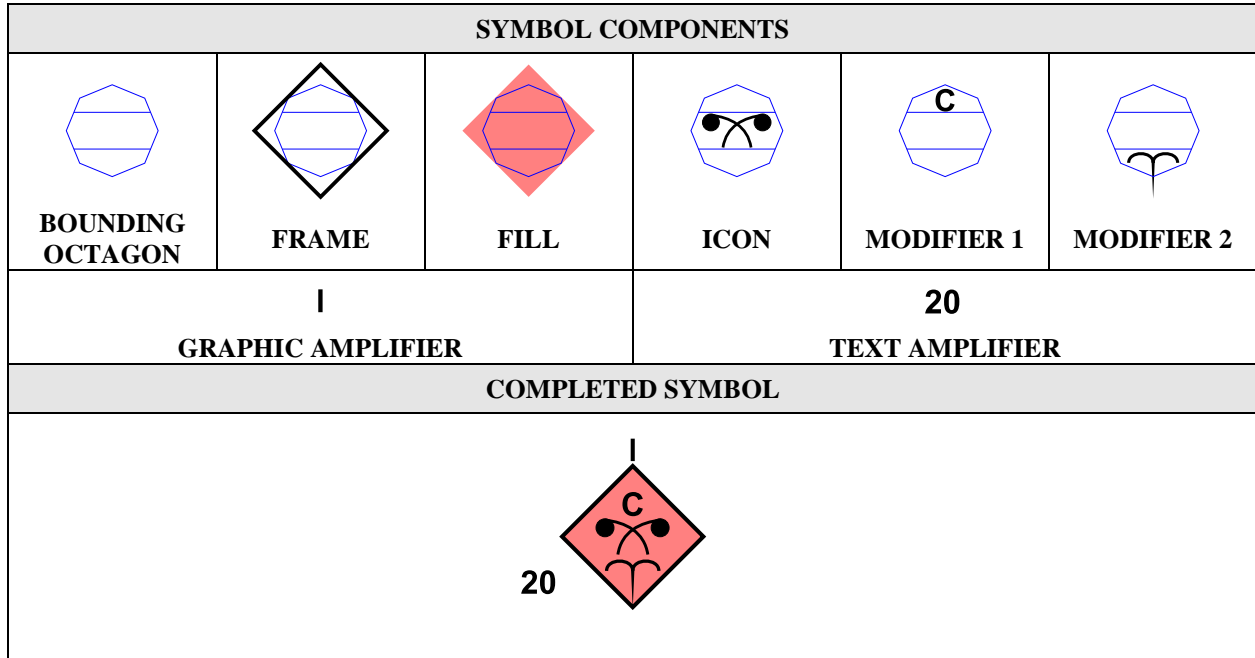



















FIGURE 20. Composition of an icon-based symbol.

5.3.8.1 Symbol display hierarchy. C2 systems differ in their operational requirements concerning the amount of information about an object to be displayed. As a result, this document standardizes those symbology elements required to achieve interoperability in information presentation and allows flexibility in the symbol components that are displayed to the warfighter. Display options range from complex, such as a symbol displaying a frame, fill, icon and modifiers, to primitive, such as a symbol rendered as a dot that denotes the presence of an object at a specific location. [Table XIV](#) provides examples of display options that can be used in color and monochrome displays and can be either hand-drawn or computer generated. The examples in the table depict some of the display options for the two symbols. Based on operational requirements, systems may be implemented with a fixed set of display options or with the ability to allow warfighters to select one or more display options. If the amplifying information provided by internal icons and modifiers is not required by the warfighter, the symbols may be displayed with frame or frame and fill only, omitting the icons and modifiers. Any display options in [table XIV](#) are compliant with this standard. If a system is implemented with multiple display options, the warfighter may be allowed to select a single option for rendering all symbols or to select different options based on the standard identity or battle dimension of the object and the amount of information required. For example, the warfighter may choose to display minimal information about friendly objects (displaying these symbols as dots) and maximal information about potential threats (displaying these symbols with frame, fill, icon and modifiers).

TABLE XIV. Symbol display options.

EXAMPLES		DISPLAY OPTION DESCRIPTIONS
CARRIER	FERRY	
		<p>Frame: ON (black or white depending on background) Fill: ON (use default color indicating standard identity) Icon: ON (black or white) Modifiers: ON (civilian sea surface symbols do not permit modifiers) Note: The first column example is a MILITARY COMBATANT, CARRIER with modifiers for HELICOPTER EQUIPPED and NUCLEAR POWERED. The second column example is a CIVILIAN, MERCHANT SHIP and FERRY.</p>
		<p>Frame: ON (black or white depending on background) Fill: OFF Icon: ON (black or white) Modifiers: ON</p>
		<p>Frame: ON (use default color indicating standard identity) Fill: OFF Icon: ON (use default color indicating standard identity) Modifiers: ON</p>
N/A		<p>Frame: OFF Fill: ON Icon: ON (use default color indicating standard identity) Modifiers: N/A (civilian sea surface symbols do not permit modifiers) Note: Only land equipment and civilian sea surface symbols can be displayed without a frame. For civilian white-filled icons, the white-fill should be changed to the color indicating its standard identity.</p>
		<p>Frame: ON (black or white depending on background) Fill: ON (use default color indicating standard identity) Icon: OFF Modifiers: OFF Note: The examples show the dimension level display of CARRIER and FERRY. The CARRIER and FERRY icons, including their parent icons, are not displayed.</p>
		<p>Frame: ON Fill: ON Icon: ON Modifiers: OFF Note: The examples show the entity level display of CARRIER (MILITARY COMBATANT) and FERRY (CIVILIAN).</p>
		<p>Frame: ON Fill: ON Icon: ON Modifiers: OFF Note: The examples show the entity type level display of CARRIER and FERRY (MERCHANT SHIP).</p>
		<p>Frame: OFF Fill: ON (use default color indicating standard identity) Icon: OFF Modifiers: OFF</p>
		<p>Frame: OFF Fill: OFF Icon: OFF Modifiers: OFF Note: Use only to indicate the location of a symbol.</p>

Note: This table shows frame and fill color when displayed on a color monitor.

5.3.9 Symbol size. The relative size of each symbol and symbol component shall be consistent within a given implementation (see “Alphanumeric character and symbol sizes of [MIL-STD-1472](#) for guidance”). Each of these sizes shall be related to length L as described in 5.1.1. The minimum diameter of a symbol displayed as a dot should be 0.15L.

5.3.10 Line width. Because the symbol frame indicates both the standard identity and dimension of an object, it is critical that line width is sufficient to ensure frame legibility and discriminability at normal viewing distance (see “Symbol line width of [MIL-STD-1472](#) for guidance”). The optimum line width may differ depending on frame size and be affected by whether the frame is filled or unfilled and displayed in color or black/white. Usability testing should be performed to identify the optimum rendering for a given implementation.

5.3.11 Plotting. The plotting of tactical symbols and most point graphics shall be based on the geometric center of the symbol or graphic. The geometric center indicates the general vicinity of the center of mass of an object. Point graphics that do not use their geometric center for plotting shall be positioned based on their anchor point. If an offset location indicator is displayed with a symbol or graphic, the endpoint of the indicator shall show the object's location. If a group of tactical symbols is displayed at one location, the group may be enclosed with a bracket and the location of that group identified with an offset location indicator. An offset indicator is one option for reducing clutter when symbols overlap or are collocated. Other options for reducing visual clutter include (1) repositioning or turning off labels so that they are not obscured by other objects, with a line connecting each label to its object and/or (2) supporting variable coding of objects (e.g., high-interest objects are rendered as symbols and low-interest objects as dots). The choice of display options for addressing clutter is considered to be user specific. The positional accuracy of symbology plotting is also considered user specific.

5.3.12 Orientation. The frame and icon in framed tactical symbols shall be displayed in the orientation shown in the appendices. Equipment in the land battle dimension can be rotated to face the direction of movement only when the symbol is unframed. Control measure symbols shall be displayed in the orientation shown in appendix H. Point graphics that are positioned based on their anchor point can be rotated 90 degrees when necessary to minimize interference with other symbology or terrain features.

5.4 Compliance criteria. If common joint military symbology is implemented to visually display or present symbology, the implementation shall comply with the provisions of this standard. To be considered MIL-STD-2525 compliant, implementations must satisfy criteria related to the appearance of tactical symbols and graphics, the assembling and parsing of SIDC and the interpretation and generation of symbol representations. Each category of compliance criteria is described below:

5.4.1 Appearance of tactical symbols. The following compliance criteria apply to the appearance of tactical symbols:

5.4.1.1 The frame shape in a tactical symbol indicates the standard identity, battle dimension and status as defined in this MIL-STD.

5.4.1.2 If color is used in a tactical symbol, it indicates the standard identity as defined in this MIL-STD.

5.4.1.3 The icon in a tactical symbol is displayed as framed or unframed in accordance with framing requirements defined in this MIL-STD.

5.4.1.4 The icons in this MIL-STD are used to provide role or mission information whenever the objects for which icons are provided are displayed in a tactical symbol.

5.4.1.5 If text and/or graphic modifiers are included in a tactical symbol, they conform to the field definitions and display lengths defined in this MIL-STD.

5.4.1.6 Tactical symbol components and modifiers are sized and positioned as defined in this MIL-STD.

5.4.1.7 The rendering of tactical symbols and modifiers conform to the display options defined in [table XIV](#).

5.4.1.8 Any temporary features added to a tactical symbol conform to the display rules in this MIL-STD.

5.4.2 Appearance of tactical graphics. The following compliance criteria apply to the appearance of control measure symbols:

5.4.2.1 The icons in this MIL-STD are used to provide information for battlefield planning and managing whenever the objects for which icons are provided are displayed in a control measure symbol.

5.4.2.2 The standard identity and status of a control measure symbol are displayed using color and/or text as defined in this MIL-STD.

5.4.2.3 If text and/or graphic modifiers are included in a control measure symbol, they conform to the field definitions and display lengths defined in this MIL-STD.

5.4.2.4 Control measure symbol components and modifiers are sized and positioned as defined in this MIL-STD.

5.4.3 Assembling and parsing of SIDC. The following compliance criteria apply to the assembling and parsing of SIDC:

5.4.3.1 An implementation can assemble the correct tactical symbol or graphic and its modifier(s) from a SIDC.

5.4.3.2 An implementation can generate the SIDC that will produce the correct tactical symbol or graphic when transmitted to another MIL-STD-2525 compliant system.

5.5 Color. It is important that implementations maximize the contrast between symbology and the display background in order to provide optimum discriminability.

a. Implementers should include sufficient usability testing to ensure effective operator performance when selecting colors to render the symbology. Color luminance (or brightness) may need to vary depending on the display option(s) selected for symbols. For example, different shades of red may be needed for both filled and unfilled symbols to heighten its contrast upon its map background or display.

b. For filled symbols, this contrast can be provided by using black (RGB: 0, 0, 0) for the frame, icon, modifiers and amplifiers when filled symbols are displayed on a light background and using white (RGB: 255, 255, 255) for these elements when filled symbols are displayed on a dark background. Implementers should select specific values (e.g., in CIE, RGB, or UV terms) for the default symbol colors based on considerations such as operational requirements, hardware configuration, display background and viewing conditions (e.g., ambient lighting). [Table XV](#) lists a range of acceptable symbol colors that have been empirically validated across a variety of viewing backgrounds. [Table XV](#) lists the symbol colors in terms of RGB and their corresponding hue, saturation and luminance (HSL) values. Three sample color sets are displayed in [table XV](#). The colors for each standard identity shall vary only in terms of their luminance values (luminance terms are **in bold** in [table XV](#)). Implementers may use any of the example color sets or may choose an alternative set whose luminance values fall within the range of the light and dark color sets. Color fill ranges for the optional civilian fill have also been included. Standard identity symbol colors shall always maintain their respective hue (e.g., hostile – red, friend – blue, neutral – green, unknown – yellow). No permutations to the color fills shall be permitted, with the lone exception of having the option of using purple to denote civilian tracks. Filled symbols may be depicted as translucent. In such cases, opacity should be set at 35% (65% transparency).



c. For unfilled symbols, implementers should use the default symbol colors in [table XVI](#) unless considerations such as operational requirements, hardware configuration, display background and viewing conditions (e.g., ambient lighting) necessitate an alternate symbol color set. In the case of an alternative symbol color set, implementers should select specific values (e.g., in CIE, RGB, or UV terms) for unfilled symbols based on sufficient usability testing.

d. For control measures, this contrast can be provided by using black (RGB: 0, 0, 0) for the graphic when it is displayed on a light background and using white (RGB: 255, 255, 255) when it is displayed on a dark background. If color is used in a graphic, implementers should select specific values for the default colors in [table XVI](#) based on the same considerations as for icon-based symbols.

TABLE XV. Color range values for filled symbols.

DESCRIPTION	HAND DRAWN	COMPUTER GENERATED		
		DARK	MEDIUM	LIGHT
HOSTILE, SUSPECT, JOKER, FAKER	RED	RGB (200, 0, 0)	RGB (255, 48, 49)	RGB (255, 128, 128)
		HSL (0, 255, 100)	HSL (0, 255, 152)	HSL (0, 255, 192)
FRIEND, ASSUMED FRIEND	BLUE	RGB (0, 107, 140)	RGB (0, 168, 220)	RGB (128, 224, 255)
		HSL (138, 255, 70)	HSL (138, 255, 110)	HSL (138, 255, 192)
NEUTRAL	GREEN	RGB (0, 160, 0)	RGB (0, 226, 0)	RGB (170, 255, 170)
		HSL (85, 255, 80)	HSL (85, 255, 113)	HSL (85, 255, 213)
UNKNOWN, PENDING	YELLOW	RGB (225, 220, 0)	RGB (255, 255, 0)	RGB (255, 255, 128)
		HSL (42, 255, 110)	HSL (42, 255, 128)	HSL (42, 255, 192)
CIVILIAN (OPTIONAL FILL)	PURPLE	RGB (80, 0, 80)	RGB (128, 0, 128)	RGB (255, 161, 255)
		HSL (213, 255, 40)	HSL (213, 255, 64)	HSL (213, 255, 208)

TABLE XVI. Default colors for unfilled symbols.

DESCRIPTION	HAND DRAWN	COMPUTER GENERATED	
		ICON (RGB VALUE)	ICON COLOR
HOSTILE, SUSPECT, JOKER, FAKER	RED	RED (255, 0, 0)	
FRIEND, ASSUMED FRIEND	BLUE	CYAN (0, 255, 255)	
NEUTRAL	GREEN	NEON GREEN (0, 255, 0)	
UNKNOWN, PENDING	YELLOW	YELLOW (255, 255, 0)	
CIVILIAN (OPTIONAL)	PURPLE	MAGENTA (255, 0, 255)	

6 NOTES

(This section contains information of a general or explanatory nature that may be helpful, but is not mandatory.)

6.1 Intended use. MIL-STD-2525 is designed to enhance DOD's joint interoperability by providing sets of C2 symbols, a coding scheme for symbol automation and information transfer and technical details to support symbology for C2 systems.

6.2 Subject term (key word) listing.

Amplifier Command and Control
Civil support
Control measures
Emergency management
Graphic
Icon
Interoperability
Meteorological
Modifier
Oceanographic
Operations
Signals Intelligence
Activities
Symbol
Symbol Identification Code
Warfighter

6.3 International standardization agreement implementation. This standard implements NATO STANAG 2019/APP-6, NATO Joint Military Symbology. When changes to, revision, or cancellation of this standard are proposed, the preparing activity must coordinate the action with the US National Point of Contact for the international standardization agreement as identified in the ASSIST database at <https://assist.daps.dla.mil/>.

6.4 Changes from previous issue. Marginal notations are not used in this revision to identify changes with respect to the previous issue due to the extent of the changes.

PAGE INTENTIONALLY LEFT BLANK

APPENDIX A - SYMBOL IDENTIFICATION CODES

A.1 SCOPE.

A.1.1 Scope. This appendix outlines the procedures for developing symbol identification codes (SIDC) for symbols in MIL-STD-2525D. The use of these codes is optional but highly recommended.

A.2 APPLICABLE DOCUMENTS

Specific documents in [2.2](#) of this standard apply to this appendix.

A.3 DEFINITIONS

The definitions in [section 3](#) of this standard apply to this appendix.

A.4 GENERAL REQUIREMENTS

A.4.1 Organization. This appendix contains SIDC and their elements.

A.5 DETAILED REQUIREMENTS

A.5.1 Symbol identification codes. A symbol identification code is a numeric code that uniquely identifies the elements needed to build a MIL-STD-2525D compliant symbol. The numeric codes provide the same type of descriptions used in message formats but further focus the data to a specific domain for ease in creating the symbols with less band width.

A.5.2 Elements of the symbol identification codes. The symbol identification code is composed of eleven elements of information which are presented in two sets of ten digits. An additional set of ten digits composed of three elements must be used when a symbology originator version extension flag is used. This extension is conditional. [See figure A-1](#).

A.5.2.1 Set A - First ten digits.

Version
Standard identity
Symbol set
Status
HQ/Task Force/Dummy
Amplifier

A.5.2.2 Set B - Second ten digits.

Entity
Entity type
Entity subtype
Sector 1 modifier
Sector 2 modifier

A.5.2.3 Set C - Conditional version extension.

National or geo-political identifier
 National or geo-political symbol set version
 Specified by national or geo-political symbol set

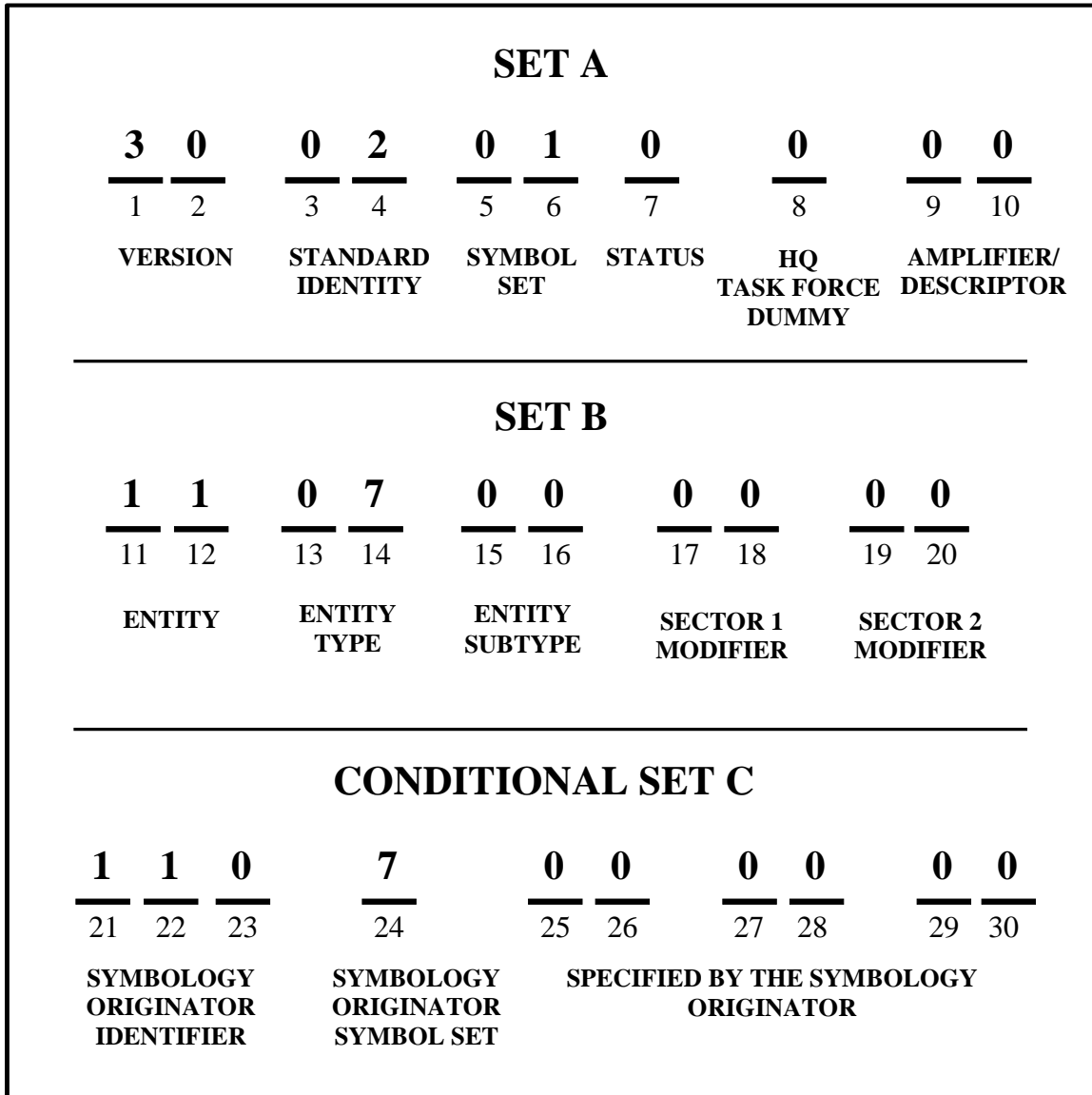

FIGURE A-1. Elements of the symbol identification code

A.5.3 Set A. The first set of ten digits:

- Digits 1 and 2 is the Version.
- Digits 3 and 4 is the Standard Identity.
- Digits 5 and 6 is the Symbol Set.
- Digit 7 is the Status.
- Digit 8 is the Headquarters/Task Force/Dummy.
- Digits 9 and 10 is the Amplifier/Descriptor.

A.5.3.1 Version. The version is comprised of two digits and identifies a version change for the SIDC which occurs when there is a change in an established icon, modifier, or drawing rule for a control measure symbol. Subsequent changes will create further version changes for the SIDC.

TABLE A-I. Version.

Description	Code	
No changes to joint military symbology	10	
Any subsequent changes to joint military symbology	11–39	

A.5.3.2 Standard identity. Standard identity is comprised of two digits. The first digit represents the context of the symbol and the second digit reflects the standard identity. The following are the entries for standard identity:

TABLE A-II. Standard identity.

Description	1st Digit	2d Digit
Context		
Reality	0	
Exercise	1	
Simulation	2	
Reserved for future use	3-9	
Standard Identity		
Pending		0
Unknown		1
Assumed Friend		2
Friend		3
Neutral		4
Suspect/Joker		5
Hostile/Faker		6
Reserved for future use		7-9

A.5.3.3 Symbol set. The symbol set is comprised of two digits.

TABLE A-III. Symbol sets.

Description	Code ¹
Unknown	00
Air	01
Air Missile	02
Space	05
Space Missile	06
Land Unit	10
Land Civilian Unit/Organization	11
Land Equipment	15
Land Installation	20
Control Measure	25
Sea Surface	30
Sea Subsurface	35
Mine Warfare	36
Activities	40
Atmospheric	45
Oceanographic	46
Meteorological Space	47
Signals Intelligence – Space	50
Signals Intelligence – Air	51
Signals Intelligence – Land	52
Signals Intelligence – Surface	53
Signals Intelligence – Subsurface	54
Cyberspace	60
(Reserved for Future Use)	03-04, 07-09, 12-14, 16-19, 21-24, 26-29, 31-34, 37-39, 41-44, 48-49, 55-59, and 61-98
Version Extension Flag	99

A.5.3.4 Status. The status is comprised of one digit.

TABLE A-IV. Status.

Description	Code
Present	0
Planned/Anticipated/Suspect	1
Present/Fully capable	2
Present/Damaged	3
Present/Destroyed	4
Present/Full to capacity	5
Reserved for future use	6 thru 8
Version extension flag	9

A.5.3.5 Headquarters/Task Force/Dummy. The headquarters/task force/dummy is comprised of one digit.

TABLE A-V. Headquarters/task force/dummy.

Description	Code
Unknown	0
Feint/Dummy	1
Headquarters	2
Feint/Dummy Headquarters	3
Task Force	4
Feint/Dummy Task Force	5
Task Force Headquarters	6
Feint/Dummy Task Force Headquarters	7
Reserved for Future Use	8
Version Extension Flag	9

A.5.3.6 Echelon/Mobility/Towed Array Amplifier. The amplifier is comprised of two digits.

TABLE A-VI. Descriptor: Echelon/mobility/towed array amplifier.

Description	1st Digit	2d Digit
<i>Unknown</i>	0	0
<i>Echelon at brigade and below</i>	1	
Team/Crew		1
Squad		2
Section		3
Platoon/detachment		4
Company/battery/troop		5
Battalion/squadron		6
Regiment/group		7
Brigade		8
Version extension flag		9
<i>Echelon at division and above</i>	2	
Division		1
Corps/MEF		2
Army		3
Army Group/front		4
Region/Theater		5
Command		6
Reserved for future use		7 thru 8
Version extension flag		9
<i>Equipment mobility on land</i>	3	
Wheeled limited cross country		1
Wheeled cross country		2
Tracked		3
Wheeled and tracked combination		4

TABLE A-VI. Descriptor: Echelon/mobility/towed array amplifier - Continued.

Description	1st Digit	2d Digit
Towed		5
Rail		6
Pack animals		7
<i>Reserved for future use</i>		8
<i>Version extension flag</i>		9
<i>Equipment mobility on snow</i>	4	
Over snow (prime mover)		1
Sled		2
<i>Reserved for future use</i>		3-8
<i>Version extension flag</i>		9
<i>Equipment mobility on water</i>	5	
Barge		1
Amphibious		2
<i>Reserved for future use</i>		3 thru 8
<i>Version extension flag</i>		9
<i>Naval towed array</i>	6	
Short towed array		1
Long towed Array		2
<i>Reserved for future use</i>		3 thru 8
<i>Version extension flag</i>		9
<i>Reserved for future use</i>	7 thru 8	
<i>Version extension flag</i>	9	9

A.5.4 Set B. The second set of ten digits:

- Digits 11 and 12 is the entity.
- Digits 13 and 14 is the entity type.
- Digits 15 and 16 is the entity subtype.
- Digits 17 and 18 is the first modifier.
- Digits 19 and 20 is the second modifier.

The entity is comprised of two digits. The entity type is comprised of two digits. The entity subtype is comprised of two digits. The first modifier is comprised of two digits. The second modifier is comprised of two digits. The tables in this section are organized by symbol sets.

A.5.4.1 Air (01)

TABLE A-VII. Air entity/entity type/entity subtype.

Entity (Digits 1 and 2)	Entity Type (Digits 3 and 4)	Entity Subtype (Digits 5 and 6)	Code Note: The actual code is shown in bold numbers. The remaining numbers are used to show placement within the six digits.
Military			110000
	Fixed Wing		110100
		Medical Evacuation (MEDEVAC)	110101
		Attack/Strike	110102
		Bomber	110103
		Fighter	110104
		Fighter/Bomber	110105
		{reserved for future use}	110106
		Cargo	110107
		Electronic Combat (EC)/Jammer	110108
		Tanker	110109
		Patrol	110110
		Reconnaissance	110111
		Trainer	110112
		Utility	110113
		Vertical or Short Take-off and Landing (VSTOL)	110114
		Airborne Command Post (ACP)	110115
		Airborne Early Warning (AEW)	110116
		Antisurface Warfare	110117
		Antisubmarine Warfare	110118
		Communications	110119
		Combat Search and Rescue (CSAR)	110120
		Electronic Support (ES)	110121
		Government	110122
		Mine Countermeasures (MCM)	110123
		Personnel Recovery	110124
		Search and Rescue	110125
		Special Operations Forces	110126
		Ultra Light	110127
		Photographic Reconnaissance	110128
		Very Important Person (VIP)	110129
		Suppression of Enemy Air Defense	110130
		Passenger	110131
		Escort	110132

MIL-STD-2525D - APPENDIX A

TABLE A-VII. Air entity/entity type/entity subtype - Continued.

Entity (Digits 1 and 2)	Entity Type (Digits 3 and 4)	Entity Subtype (Digits 5 and 6)	Code Note: The actual code is shown in bold numbers. The remaining numbers are used to show placement within the six digits.
		Electronic Attack (EA)	1101 33
	Rotary Wing		1102 00
	Unmanned Aircraft (UA) / Unmanned Aerial Vehicle (UAV) / Unmanned Aircraft System (UAS) / Remotely Piloted Vehicle (RPV)		1103 00
	Vertical-Takeoff UAV (VT-UAV)		1104 00
	Lighter Than Air		1105 00
	Airship		1106 00
	Tethered Lighter than Air		1107 00
Civilian			1200 00
	Fixed Wing		1201 00
	Rotary Wing		1202 00
	Unmanned Aircraft (UA) / Unmanned Aerial Vehicle (UAV) / Unmanned Aircraft System (UAS) / Remotely Piloted Vehicle (RPV)		1203 00
	Lighter Than Air		1204 00
	Airship		1205 00
	Tethered Lighter than Air		1206 00
Weapon			1300 00
	Bomb		1301 00
	Decoy		1302 00
Manual Track			1400 00

TABLE A-VIII. Air sector 1 modifier.

First Modifier	MIL-STD-2525D Code	Remarks.
Not Applicable	00	
Attack/Strike	01	
Bomber	02	
Cargo	03	
Fighter	04	
Interceptor	05	
Tanker	06	
Utility	07	

MIL-STD-2525D - APPENDIX A

TABLE A-VIII. Air sector 1 modifier - Continued.

First Modifier	MIL-STD-2525D Code	Remarks.
Vertical or Short Take-off and Landing (VSTOL)/ Vertical Take-off and Landing (VTOL)	08	
Passenger	09	
Ultra Light	10	
Airborne Command Post (ACP)	11	
Airborne Early Warning (AEW)	12	
Government	13	
Medical Evacuation (MEDEVAC)	14	
Escort	15	
Electronic Combat (EC)/Jammer	16	
Patrol	17	
Reconnaissance	18	
Trainer	19	
Photographic (Reconnaissance)	20	
Personnel Recovery	21	
Antisubmarine Warfare	22	
Communications	23	
Electronic Support (ES)	24	
Mine Countermeasures (MCM)	25	
Search and Rescue	26	
Special Operations Forces	27	
Surface Warfare	28	
Very Important Person (VIP) Transport	29	
Combat Search and Rescue (CSAR)	30	
Suppression of Enemy Air Defenses	31	
Antisurface Warfare	32	
Fighter/Bomber	33	
Intensive Care	34	
Electronic Attack (EA)	35	
Multimission	36	
Hijacking	37	
ASW Helo- LAMPS	38	
ASW Helo – SH-60R	39	
Reserved for Future Use	40-98	Assigned by SSMC/JSP only
Version Extension Flag	99	

TABLE A-IX. Air sector 2 modifier.

Second Modifier	MIL-STD-2525D Code	Remarks.
Not Applicable	00	
Heavy	01	
Medium	02	
Light	03	
Boom-Only	04	
Drogue-Only	05	
Boom and Drogue	06	
Close Range	07	
Short Range	08	
Medium Range	09	

MIL-STD-2525D - APPENDIX A

TABLE A-IX. Air sector 2 modifier - Continued.

Second Modifier	MIL-STD-2525D Code	Remarks.
Long Range	10	
Downlinked	11	
Reserved for Future Use	12-98	Assigned by SSMC/JSP only
Version Extension Flag	99	

A.5.4.2 Air missile (02).

TABLE A-X. Air missile entity/entity type/entity subtype.

Entity (Digits 1 and 2)	Entity Type (Digits 3 and 4)	Entity Subtype (Digits 5 and 6)	Code Note: The actual code is shown in bold numbers. The remaining numbers are used to show placement within the six digits.
Missile			110000

TABLE A-XI. Air missile sector 1 modifier.

First Modifier	MIL-STD-2525D Code	Remarks.
Unspecified	00	
Air	01	
Surface	02	
Subsurface	03	
Space	04	
Anti-Ballistic	05	
Ballistic	06	
Cruise	07	
Interceptor	08	
Reserved for Future Use	09-98	Assigned by SSMC/JSP only
Version Extension Flag	99	

TABLE A-XII. Air missile sector 2 modifier.

Second Modifier	MIL-STD-2525D Code	Remarks.
Unspecified	00	
Air	01	
Surface	02	
Subsurface	03	
Space	04	
Launched	05	
Missile	06	
Patriot	07	
Standard Missile-2 (SM-2)	08	
Standard Missile-6 (SM-6)	09	
Evolved Sea Sparrow Missile (ESSM)	10	
Rolling Airframe Missile (RAM)	11	

TABLE A-XII. Air missile sector 2 modifier - Continued.

Short Range	12	
Medium Range	13	
Intermediate Range	14	
Long Range	15	
Intercontinental	16	
Reserved for Future Use	17-98	Assigned by SSMC/JSP only
Version Extension Flag	99	

A.5.4.3 Space (05).TABLE A-XIII. Space entity/entity type/entity subtype.

Entity (Digits 1 and 2)	Entity Type (Digits 3 and 4)	Entity Subtype (Digits 5 and 6)	Code Note: The actual code is shown in bold numbers. The remaining numbers are used to show placement within the six digits.
Military			110000
	Space Vehicle		110100
	Re-Entry Vehicle		110200
	Planet Lander		110300
	Orbiter Shuttle		110400
	Capsule		110500
	Satellite, General		110600
	Satellite		110700
	Antisatellite Weapon		110800
	Astronomical Satellite		110900
	Biosatellite		111000
	Communications Satellite		111100
	Earth Observation Satellite		111200
	Miniaturized Satellite		111300
	Navigational Satellite		111400
	Reconnaissance Satellite		111500
	Space Station		111600
	Tethered Satellite		111700
	Weather Satellite		111800
	Space Launched Vehicle (SLV)		111900
Civilian			120000
	Orbiter Shuttle		120100
	Capsule		120200
	Satellite		120300
	Astronomical Satellite		120400
	Biosatellite		120500
	Communications Satellite		120600
	Earth Observation Satellite		120700

MIL-STD-2525D - APPENDIX A

TABLE A-XIII. Space entity/entity type/entity subtype - Continued.

Entity (Digits 1 and 2)	Entity Type (Digits 3 and 4)	Entity Subtype (Digits 5 and 6)	Code Note: The actual code is shown in bold numbers. The remaining numbers are used to show placement within the six digits.
	Miniaturized Satellite		120800
	Navigational Satellite		120900
	Space Station		121000
	Tethered Satellite		121100
	Weather Satellite		121200
Manual Track			130000

TABLE A-XIV. Space sector 1 modifier.

Second Modifier	MIL-STD-2525D Code	Remarks.
Unspecified	00	
Low Earth Orbit (LEO)	01	
Medium Earth Orbit (MEO)	02	
High Earth Orbit (HEO)	03	
Geosynchronous Orbit (GSO)	04	
Geostationary Orbit (GO)	05	
Molniya Orbit (MO)	06	
Reserved for Future Use	07-98	Assigned by SSMC/JSP only
Version Extension Flag	99	

TABLE A-XV. Space sector 2 modifier.

Second Modifier	MIL-STD-2525D Code	Remarks.
Unspecified	00	
Optical	01	
Infrared	02	
Radar	03	
Signals Intelligence (SIGINT)	04	
Reserved for Future Use	05-98	Assigned by SSMC/JSP only
Version Extension Flag	99	

A.5.4.4 Space missile (06).

TABLE A-XVI. Space missile entity/entity type/entity subtype.

Entity (Digits 1 and 2)	Entity Type (Digits 3 and 4)	Entity Subtype (Digits 5 and 6)	Code Note: The actual code is shown in bold numbers. The remaining numbers are used to show placement within the six digits.
Missile			110000

TABLE A-XVII. Space missile sector 1 modifier.

First Modifier	MIL-STD-2525D Code	Remarks.
Unspecified	00	
Ballistic	01	
Space	02	
Interceptor	03	
Reserved for Future Use	04-98	Assigned by SSMC/JSP only
Version Extension Flag	99	

TABLE A-XVIII. Space missile sector 2 modifier.

First Modifier	MIL-STD-2525D Code	Remarks.
Unspecified	00	
Short Range	01	
Medium Range	02	
Intermediate Range	03	
Long Range	04	
Intercontinental	05	
Arrow	06	
Ground-Based Interceptor (GBI)	07	
Patriot	08	
Standard Missile Terminal Phase (SM-T)	09	
Standard Missile – 3 (SM-3)	10	
Terminal High Altitude Area Defense (THAAD)	11	
Space	12	
Reserved for Future Use	13-98	Assigned by SSMC/JSP only
Version Extension Flag	99	

MIL-STD-2525D - APPENDIX A

A.5.4.5 Land unit (10).

TABLE A-XIX. Land unit entity/entity type/entity subtype.

Entity (Digits 1 and 2)	Entity Type (Digits 3 and 4)	Entity Subtype (Digits 5 and 6)	Code Note: The actual code is shown in bold numbers. The remaining numbers are used to show placement within the six digits.
Command and Control			110000
	Broadcast Transmitter Antennae		11 0 100
	Civil Affairs		11 0 200
	Civil–Military Cooperation		11 0 300
	Information Operations		11 0 400
	Liaison		11 0 500
	Military Information Support Operations (MISO)		11 0 600
		Broadcast Transmitter Antennae	110 6 01
	Radio		110 7 00
	Radio Relay		110 8 00
	Radio Teletype Center		110 9 00
	Signal		11 1 000
		Radio	111 0 01
		Radio Relay	111 0 02
		Teletype	111 0 03
		Tactical Satellite	111 0 04
		Video Imagery (Combat Camera)	111 0 05
	Tactical Satellite		111 1 00
	Video Imagery (Combat Camera)		111 2 00
Movement and Maneuver			120000
	Air Assault with Organic Lift		120 1 00
	Air Traffic Services/Airfield Operations		120 2 00
	Amphibious		120 3 00
	Antitank/Antiarmor		120 4 00
		Armored	120 4 01
		Motorized	120 4 02
	Armor/Armored/Mechanized/Self-Propelled/ Tracked		120 5 00
		Reconnaissance/Cavalry/Scout	120 5 01
		Amphibious	120 5 02
	Army Aviation/Aviation Rotary Wing		120 6 00

TABLE A-XIX. Land unit entity/entity type/entity subtype - Continued.

Entity (Digits 1 and 2)	Entity Type (Digits 3 and 4)	Entity Subtype (Digits 5 and 6)	Code Note: The actual code is shown in bold numbers. The remaining numbers are used to show placement within the six digits.
		Reconnaissance	120 601
	Aviation Composite		120 700
	Aviation Fixed Wing		120 800
		Reconnaissance	120 801
	Combat		120 900
	Combined Arms		121 000
	Infantry		121 100
		Amphibious	121 101
		Armored/Mechanized/Tracked	121 102
		Main Gun System	121 103
		Motorized	121 104
		Infantry Fighting Vehicle	121 105
	Observer		121 200
	Reconnaissance/Cavalry/Scout		121 300
		Reconnaissance and Surveillance	121 301
		Marine	121 302
		Motorized	121 303
	Sea Air Land (SEAL)		121 400
	Sniper		121 500
	Surveillance		121 600
	Special Forces		121 700
	Special Operations Forces (SOF)		121 800
		Fixed Wing MISO	121 801
		Ground	121 802
		Special Boat	121 803
		Special SSNR	121 804
		Underwater Demolition Team	121 805
	Unmanned Aerial Systems		121 900
Fires			130000
	Air Defense		130 100
		Main Gun System	130 101
		Missile	130 102
	Air/Land Naval Gunfire Liaison		130 200
	Field Artillery		130 300
		Self-propelled	130 301
		Target Acquisition	130 302

MIL-STD-2525D - APPENDIX A

TABLE A-XIX. Land unit entity/entity type/entity subtype - Continued.

Entity (Digits 1 and 2)	Entity Type (Digits 3 and 4)	Entity Subtype (Digits 5 and 6)	Code Note: The actual code is shown in bold numbers. The remaining numbers are used to show placement within the six digits.
	Field Artillery Observer		130400
	Joint Fire Support		130500
	Meteorological		130600
	Missile		130700
	Mortar		130800
		Armored/Mechanized/Tracked	130801
		Self-Propelled Wheeled	130802
		Towed	130803
	Survey		130900
Protection			140000
	Chemical Biological Radiological Nuclear Defense		140100
		Mechanized	140101
		Motorized	140102
		Reconnaissance	140103
		Reconnaissance Armored	140104
		Reconnaissance Equiped	140105
	Combat Support (Maneuver Enhancement)		140200
	Criminal Investigation Division		140300
	Diving		140400
	Dog		140500
	Drilling		140600
	Engineer		140700
		Mechanized	140701
		Motorized	140702
		Reconnaissance	140703
	Explosive Ordnance Disposal (EOD)		140800
	Field Camp Construction		140900
	Fire Fighting/Fire Protection		141000
	Geospatial Support/Geospatial Information Support		141100
	Military Police		141200
	Mine		141300
	Mine Clearing		141400
	Mine Launching		141500
	Mine Laying		141600
	Security		141700

MIL-STD-2525D - APPENDIX A

TABLE A-XIX. Land unit entity/entity type/entity subtype - Continued.

Entity (Digits 1 and 2)	Entity Type (Digits 3 and 4)	Entity Subtype (Digits 5 and 6)	Code Note: The actual code is shown in bold numbers. The remaining numbers are used to show placement within the six digits.
		Mechanized	141 701
		Motorized	141 702
	Search and Rescue		141 800
	Security Police (Air)		141 900
	Shore Patrol		142 000
	Topographic		142 100
Intelligence			150000
	Analysis		150 100
	Counterintelligence		150 200
	Direction Finding		150 300
	Electronic Ranging		150 400
	Electronic Warfare		150 500
		Analysis	1505 01
		Direction Finding	1505 02
		Intercept	1505 03
		Jamming	1505 04
		Search	1505 05
	Intercept (Search and Recording)		150 600
	Interrogation		150 700
	Jamming		150 800
	Joint Intelligence Center		150 900
	Military Intelligence		151 000
	Search		151 100
	Sensor		151 200
Sustainment			160000
	Administrative		160 100
	All Classes of Supply		160 200
	Airport of Debarkation/Airport of Embarkation		160 300
	Ammunition		160 400
	Band		160 500
	Combat Service Support		160 600
	Finance		160 700
	Judge Advocate General		160 800
	Labor		160 900
	Laundry/Bath		161 000
	Maintenance		161 100

TABLE A-XIX. Land unit entity/entity type/entity subtype - Continued.

Entity (Digits 1 and 2)	Entity Type (Digits 3 and 4)	Entity Subtype (Digits 5 and 6)	Code Note: The actual code is shown in bold numbers. The remaining numbers are used to show placement within the six digits.
	Material		16 1 200
	Medical		16 1 300
	Medical Treatment Facility		16 1 400
	Morale, Welfare and Recreation		16 1 500
	Mortuary Affairs/Graves Registration		16 1 600
	Multiple Classes of Supply		16 1 700
	NATO Supply Class I		16 1 800
	NATO Supply Class II		16 1 900
	NATO Supply Class III		16 2 000
	NATO Supply Class IV		16 2 100
	NATO Supply Class V		16 2 200
	Ordnance		16 2 300
	Personnel Services		16 2 400
	Petroleum, Oil and Lubricants		16 2 500
	Pipeline		16 2 600
	Postal		16 2 700
	Public Affairs/Public Information		16 2 800
	Quartermaster		16 2 900
	Railhead		16 3 000
	Religious Support		16 3 100
	Replacement Holding Unit		16 3 200
	Sea Port of Debarkation/Sea Port of Embarkation		16 3 300
	Supply		16 3 400
	Joint Information Bureau		16 3 500
	Transportation		16 3 600
	US Supply Class I		16 3 700
	US Supply Class II		16 3 800
	US Supply Class III		16 3 900
	US Supply Class IV		16 4 000
	US Supply Class V		16 4 100
	US Supply Class VI		16 4 200
	US Supply Class VII		16 4 300
	US Supply Class VIII		16 4 400
	US Supply Class IX		16 4 500
	US Supply Class X		16 4 600

TABLE A-XIX. Land unit entity/entity type/entity subtype - Continued.

Entity (Digits 1 and 2)	Entity Type (Digits 3 and 4)	Entity Subtype (Digits 5 and 6)	Code Note: The actual code is shown in bold numbers. The remaining numbers are used to show placement within the six digits.
	Water		164 7 00
	Water Purification		164 8 00
	Broadcast		164 9 00
Naval			17 0000
	Naval		17 0 100
Named Headquarters			18 0000
	Allied Command Europe Rapid Reaction Corps (ARRC)		18 0 100
	Allied Command Operations		18 0 200
	International Security Assistance Force (ISAF)		18 0 300
	Multinational (MN)		18 0 400
Emergency Operation			19 0000
Law Enforcement			20 0000
	Bureau of Alcohol, Tobacco, Firearms and Explosives (ATF) (Department of Justice)		20 0 100
	Border Patrol		20 0 200
	Customs Service		20 0 300
	Drug Enforcement Administration (DEA)		20 0 400
	Department of Justice (DOJ)		20 0 500
	Federal Bureau of Investigation (FBI)		20 0 600
	Police		20 0 700
	Prison		20 0 800
	United States Secret Service (USSS)		20 0 900
	Transportation Security Administration (TSA)		20 1 000
	Coast Guard		20 1 100
	US Marshals Service		20 1 200
	Internal Security Force		20 1 300

MIL-STD-2525D - APPENDIX A

TABLE A-XX. Land unit sector 1 modifier.

First Modifier	MIL-STD-2525D Code	Remarks.
Unspecified	00	
Air Mobile/Air Assault (US only)	01	
Area	02	
Attack	03	
Biological	04	
Border	05	
Bridging	06	
Chemical	07	
Close Protection	08	
Combat	09	
Command and Control	10	
Communications Contingency Package	11	
Construction	12	
Cross Cultural Communication	13	
Crowd and Riot Control	14	
Decontamination	15	
Detention	16	
Direct Communications	17	
Diving	18	
Division	19	
Dog	20	
Drilling	21	
Electro-Optical	22	
Enhanced	23	
Explosive Ordnance Disposal (EOD)	24	
Fire Direction Center	25	
Force	26	
Forward	27	
Ground Station Module	28	
Landing Support	29	
Large Extension Node	30	
Maintenance	31	
Meteorological	32	
Mine Countermeasure	33	
Missile	34	
Mobile Advisor and Support	35	
Mobile Subscriber Equipment	36	
Mobility Support	37	
Movement Control Center	38	
Multinational	39	
Multinational Specialized Unit	40	
Multiple Rocket Launcher	41	
NATO Medical Role 1	42	
NATO Medical Role 2	43	
NATO Medical Role 3	44	
NATO Medical Role 4	45	
Naval	46	
Node Center	47	

MIL-STD-2525D - APPENDIX A

TABLE A-XX. Land unit sector 1 modifier - Continued.

First Modifier	MIL-STD-2525D Code	Remarks.
Nuclear	48	
Operations	49	
Radar	50	
Radio Frequency Identification (RFID) Interrogator / Sensor	51	
Radiological	52	
Search and Rescue	53	
Security	54	
Sensor	55	
Sensor Control Module (SCM)	56	
Signals Intelligence	57	
Single Shelter Switch	58	
Single Rocket Launcher	59	
Smoke	60	
Sniper	61	
Sound Ranging	62	
Special Operations Forces (SOF)	63	
Special Weapons and Tactics	64	
Survey	65	
Tactical Exploitation	66	
Target Acquisition	67	
Topographic	68	
Utility	69	
Video Imagery (Combat Camera)	70	
Accident	71	
Other	72	
Civilian	73	
Antisubmarine Warfare	74	
Medevac	75	
Ranger	76	
Support	77	
Aviation	78	
Reserved for Future Use	79-98	Assigned by SSMC/JSP only
Version Extension Flag	99	

TABLE A-XXI. Land unit sector 2 modifier.

Second Modifier	MIL-STD-2525D Code	Remarks.
Unspecified	00	
Airborne	01	
Arctic	02	
Battle Damage Repair	03	
Bicycle Equipped	04	
Casualty Staging	05	
Clearing	06	
Close Range	07	
Control	08	

MIL-STD-2525D - APPENDIX A

TABLE A-XXI. Land unit sector 2 modifier - Continued.

Second Modifier	MIL-STD-2525D Code	Remarks.
Decontamination	09	
Demolition	10	
Dental	11	
Digital	12	
Enhanced Position Location Reporting System (EPLRS)	13	
Equipment	14	APP6
Heavy	15	
High Altitude	16	
Intermodal	17	
Intensive Care	18	
Light	19	
Laboratory	20	
Launcher	21	
Long Range	22	
Low Altitude	23	
Medium	24	
Medium Altitude	25	
Medium Range	26	
Mountain	27	
High to Medium Altitude	28	
Multi-Channel	29	
Optical (Flash)	30	
Pack Animal	31	
Patient Evacuation Coordination	32	
Preventive Maintenance	33	
Psychological	34	
Radio Relay Line of Sight	35	
Railroad	36	
Recovery (Unmanned Systems)	37	
Recovery (Maintenance)	38	
Rescue Coordination Center	39	
Riverine	40	
Single Channel	41	
Ski	42	
Short Range	43	
Strategic	44	
Support	45	
Tactical	46	
Towed	47	
Troop	48	
Vertical or Short Take-Off and Landing (VTOL/VSTOL)	49	
Veterinary	50	
Wheeled	51	
High to Low Altitude	52	
Medium to Low Altitude	53	
Attack	54	

MIL-STD-2525D - APPENDIX A

TABLE A-XXI. Land unit sector 2 modifier - Continued.

Second Modifier	MIL-STD-2525D Code	Remarks.
Refuel	55	
Utility	56	
Combat Search and Rescue	57	
Reserved for Future Use	58-98	Assigned by SSMC/JSP only
Version Extension Flag	99	

A.5.4.6 Land civilian unit/organization (11).

TABLE A-XXII. Land civilian unit/organization entity/entity type/entity subtype.

Entity (Digits 1 and 2)	Entity Type (Digits 3 and 4)	Entity Subtype (Digits 5 and 6)	Code Note: The actual code is shown in bold numbers. The remaining numbers are used to show placement within the six digits.
Civilian			110000
	Environmental Protection		110100
	Governmental Organization		110200
	Individual		110300
	Organization or Group		110400
	Killing Victim		110500
	Killing Victims		110600
	Victim of an Attempted Crime		110700
	Spy		110800
	Composite Loss		110900
	Emergency Medical Operation		111000

TABLE A-XXIII. Land civilian unit/organization sector 1 modifier.

First Modifier	MIL-STD-2525D Code	Remarks.
Unspecified	00	
Assassination	01	
Execution (Wrongful Killing)	02	
Murder Victims	03	
Hijacking	04	
Kidnapping	05	
Piracy	06	
Rape	07	
Civilian	08	
Displaced Person(s), Refugee(s) and Evacuee(s)	09	
Foreign Fighter(s)	10	
Gang Member or Gang	11	

TABLE A-XXIII. Land civilian unit/organization sector 1 modifier - Continued.

Government Organization	12	
Leader or Leadership	13	
Nongovernmental Organization Member or Nongovernmental Organization	14	
Coerced/Impressed Recruit	15	
Willing Recruit	16	
Religious or Religious Organization	17	
Targeted Individual or Organization	18	
Terrorist or Terrorist Organization	19	
Speaker	20	
Accident	21	
Combat	22	
Other	23	
Loot	24	
Reserved for Future Use	25-98	Assigned by SSMC/JSP only
Version Extension Flag	99	

TABLE A-XXIV. Land civilian unit/organization sector 2 modifier.

Second Modifier	MIL-STD-2525D Code	Remarks.
Unspecified	00	
Leader or Leadership	01	
Reserved for Future Use	02-98	Assigned by SSMC/JSP only
Version Extension Flag	99	

A.5.4.7 Land Equipment (15).

TABLE A-XXV. Land equipment entity/entity type/entity subtype.

Entity (Digits 1 and 2)	Entity Type (Digits 3 and 4)	Entity Subtype (Digits 5 and 6)	Code Note: The actual code is shown in bold numbers. The remaining numbers are used to show placement within the six digits.
Weapons/Weapons System			110000
	Rifle		110100
		Single Shot Rifle	110101
		Semiautomatic Rifle	110102
		Automatic Rifle	110103
	Machine Gun		110200
		Light	110201
		Medium	110202
		Heavy	110203
	Grenade Launcher		110300
		Light	110301

MIL-STD-2525D - APPENDIX A

TABLE A-XXV. Land equipment entity/entity type/entity subtype - Continued.

Entity (Digits 1 and 2)	Entity Type (Digits 3 and 4)	Entity Subtype (Digits 5 and 6)	Code Note: The actual code is shown in bold numbers. The remaining numbers are used to show placement within the six digits.
		Medium	1103 02
		Heavy	1103 03
	Flame Thrower		110 400
	Air Defense Gun		110 500
		Light	110 501
		Medium	110 502
		Heavy	110 503
	Antitank Gun		110 600
		Light	110 601
		Medium	110 602
		Heavy	110 603
	Direct Fire Gun		110 700
		Light	110 701
		Medium	110 702
		Heavy	110 703
	Recoilless Gun		110 800
		Light	110 801
		Medium	110 802
		Heavy	110 803
	Howitzer		110 900
		Light	110 901
		Medium	110 902
		Heavy	110 903
	Missile Launcher		111 000
		Light	111 001
		Medium	111 002
		Heavy	111 003
	Air Defense Missile Launcher		111 100
		Light	111 101
		Light, Light Transporter-Launcher and Radar (TLAR)	111 102
		Light, Light Tactical Landing Approach Radar (TELAR)	111 103
		Medium	111 104
		Medium, TLAR	111 105
		Medium, TELAR	111 106
		Heavy	111 107
		Heavy, TLAR	111 108
		Heavy, TELAR	111 109

TABLE A-XXV. Land equipment entity/entity type/entity subtype - Continued.

Entity (Digits 1 and 2)	Entity Type (Digits 3 and 4)	Entity Subtype (Digits 5 and 6)	Code Note: The actual code is shown in bold numbers. The remaining numbers are used to show placement within the six digits.
	Antitank Missile Launcher		111200
		Light	111201
		Medium	111202
		Heavy	111203
	Surface-to-Surface Missile Launcher		111300
		Light	111301
		Medium	111302
		Heavy	111303
	Mortar		111400
		Light	111401
		Medium	111402
		Heavy	111403
	Single Rocket Launcher		111500
		Light	111501
		Medium	111502
		Heavy	111503
	Multiple Rocket Launcher		111600
		Light	111601
		Medium	111602
		Heavy	111603
	Antitank Rocket Launcher		111701
		Light	111701
		Medium	111702
		Heavy	111703
	Nonlethal Weapon		111800
	Taser		111900
	Water Cannon		112000
Vehicle			120000
	Armored		120100
		Armored Fighting Vehicle	120101
		Armored Fighting Vehicle Command and Control	120102
		Armored Personnel Carrier	120103
		Armored Personnel Carrier Ambulance	120104
		Armored Protected Vehicle	120105
		Armored Protected Vehicle Recovery	120106
		Armored Protected Vehicle Medical Evacuation	120107

MIL-STD-2525D - APPENDIX A

TABLE A-XXV. Land equipment entity/entity type/entity subtype - Continued.

Entity (Digits 1 and 2)	Entity Type (Digits 3 and 4)	Entity Subtype (Digits 5 and 6)	Code Note: The actual code is shown in bold numbers. The remaining numbers are used to show placement within the six digits.
		Armored Personnel Carrier, Recovery	1201 08
		Combat Service Support Vehicle	1201 09
		Light Wheeled Armored Vehicle	1201 10
	Tank		1202 00
		Light	1202 01
		Medium	1202 02
		Heavy	1202 03
	Tank Recovery Vehicle		1203 00
		Light	1203 01
		Medium	1203 02
		Heavy	1203 03
Engineer Vehicles and Equipment			130000
	Bridge		130 100
	Bridge Mounted on Utility Vehicle		1302 00
	Fixed Bridge		1303 00
	Floating Bridge		1304 00
	Folding Girder Bridge		1305 00
	Hollow Deck Bridge		1306 00
	Drill		1307 00
		Drill Mounted on Utility Vehicle	1307 01
	Earthmover		1308 00
		Multifunctional Earthmover/Digger	1308 01
	Mine Clearing Equipment		1309 00
		Trailer Mounted	1309 01
		Mine Clearing Equipment on Tank Chassis	1309 02
	Mine Laying Equipment		1310 00
		Mine Laying Equipment on Utility Vehicle	1310 01
		Armored Carrier with Volcano	1310 02
		Truck Mounted with Volcano	1310 03
	Dozer		1311 00
		Dozer , Armored	1311 01
	Armored Assault		1312 00
	Armored Engineer Recon Vehicle (AERV)		1313 00
	Backhoe		1314 00
	Construction Vehicle		1315 00

MIL-STD-2525D - APPENDIX A

TABLE A-XXV. Land equipment entity/entity type/entity subtype - Continued.

Entity (Digits 1 and 2)	Entity Type (Digits 3 and 4)	Entity Subtype (Digits 5 and 6)	Code Note: The actual code is shown in bold numbers. The remaining numbers are used to show placement within the six digits.
	Ferry Transporter		131600
Utility Vehicles			140000
	Utility Vehicle		140 100
	Medical		140 200
	Medical Evacuation		140 300
	Mobile Emergency Physician		140 400
	Bus		140 500
	Semi-Trailer and Truck		140 600
		Light	1406 01
		Medium	1406 02
		Heavy	1406 03
	Limited Cross Country Truck		140 700
	Cross Country Truck		140 800
	Petroleum, Oil and Lubricant		140 900
	Water		141 000
	Amphibious Utility Wheeled Vehicle		141 100
	Tow Truck		141 200
		Light	1412 01
		Heavy	1412 02
Train			150000
	Locomotive		150 100
	Railcar		150 200
Civilian Vehicle			160000
	Automobile		160 100
		Compact	1601 01
		Midsize	1601 02
		Sedan	1601 03
	Open-Bed Truck		160 200
		Pickup	1602 01
		Small	1602 02
		Large	1602 03
	Multiple Passenger Vehicle		160 300
		Van	1603 01
		Small Bus	1603 02
		Large Bus	1603 03
	Utility Vehicle		160 400
		Sport Utility Vehicle (SUV)	1604 01
		Small Box Truck	1604 02

MIL-STD-2525D - APPENDIX A

TABLE A-XXV. Land equipment entity/entity type/entity subtype - Continued.

Entity (Digits 1 and 2)	Entity Type (Digits 3 and 4)	Entity Subtype (Digits 5 and 6)	Code Note: The actual code is shown in bold numbers. The remaining numbers are used to show placement within the six digits.
		Large Box Truck	1604 03
	Jeep Type Vehicle		160 5 00
		Small/Light	160 5 01
		Medium	160 5 02
		Large/Heavy	160 5 03
	Tractor Trailer Truck with Box		160 6 00
		Small/Light	160 6 01
		Medium	160 6 02
		Large/Heavy	160 6 03
	Tractor Trailer Truck with Flatbed Trailer		160 7 00
		Small/Light	160 7 01
		Medium	160 7 02
		Large/Heavy	160 7 03
	Known Insurgent Vehicle		160 8 00
	Drug Vehicle		160 9 00
Law Enforcement			170 0 00
	Bureau of Alcohol, Tobacco, Firearms and Explosives (ATF) (Department of Justice)		170 1 00
	Border Patrol		170 2 00
	Customs Service		170 3 00
	Drug Enforcement Administration (DEA)		170 4 00
	Department of Justice (DOJ)		170 5 00
	Federal Bureau of Investigation (FBI)		170 6 00
	Police		170 7 00
	United States Secret Service (USSS)		170 8 00
	Transportation Security Administration (TSA)		170 9 00
	Coast Guard		171 0 00
	US Marshals Service		171 1 00
Pack Animals			180 0 00
Missile Support			190 0 00
	Transloader		190 1 00
	Transporter		190 2 00

MIL-STD-2525D - APPENDIX A

TABLE A-XXV. Land equipment entity/entity type/entity subtype - Continued.

Entity (Digits 1 and 2)	Entity Type (Digits 3 and 4)	Entity Subtype (Digits 5 and 6)	Code Note: The actual code is shown in bold numbers. The remaining numbers are used to show placement within the six digits.
	Crane/Loading Device		190 300
	Propellant Transporter		190 400
	Warhead Transporter		190 500
Other Equipment			200000
	Antennae		200 100
	Bomb		200 200
	Booby Trap		200 300
	CBRN Equipment		200 400
	Computer System		200 500
	Command Launch Equipment (CLE)		200 600
	Generator Set		200 700
	Ground-based Midcourse Defense (GMD) Fire Control (GFC) Center		200 800
	In-Flight Interceptor Communications System (IFICS) Data Terminal (IDT)		200 900
	Laser		201 000
	Military Information Support Operations (MISO)		201 100
	Sustainment Shipments		201 200
	Tent		201 300
	Unit Deployment Shipments		201 400
	Emergency Medical Operation		201 500
		Medical Evacuation Helicopter	201 501
Land Mines			210000
	Land Mine		210 100
	Antipersonnel Land mine (APL)		210 200
	Antitank Mine		210 300
	Improvised Explosives Device (IED)		210 400
	Less than lethal		210 500
Sensors			220000
	Sensor		220 100
	Sensor Emplaced		220 200
	Radar		220 300
Emergency Operation			230000
	Ambulance		230 100

TABLE A-XXV. Land equipment entity/entity type/entity subtype - Continued.

Entity (Digits 1 and 2)	Entity Type (Digits 3 and 4)	Entity Subtype (Digits 5 and 6)	Code Note: The actual code is shown in bold numbers. The remaining numbers are used to show placement within the six digits.
	Fire Fighting/Fire Protection		230 200
Manual Track			240000

TABLE A-XXVI. Land equipment sector 1 modifier.

First Modifier	MIL-STD-2525D Code	Remarks.
Unspecified	00	
Biological	01	
Chemical	02	
Early Warning Radar	03	
Intrusion	04	
Nuclear	05	
Radiological	06	
Upgraded Early Warning Radar	07	
Hijacking	08	
Civilian	09	
Reserved for Future Use	10-98	Assigned by SSMC/JSP only
Version Extension Flag	99	

A.5.4.8 Land installations (20).

TABLE A-XXVII. Land installation entity/entity type/entity subtype.

Entity (Digits 1 and 2)	Entity Type (Digits 3 and 4)	Entity Subtype (Digits 5 and 6)	Code Note: The actual code is shown in bold numbers. The remaining numbers are used to show placement within the six digits.
Military/Civilian			110000
	Aircraft Production/Assembly		110100
	Ammunition and Explosives/Assembly		110200
	Ammunition Cache		110300
	Armament Production		110400
	Black List Location		110500
	Chemical, Biological, Radiological and Nuclear (CBRN)		110600
	Engineering Equipment Production		110700
		Bridge	110701
	Equipment Manufacture		110800

MIL-STD-2525D - APPENDIX A

TABLE A-XXVII. Land installation entity/entity type/entity subtype - Continued.

Entity (Digits 1 and 2)	Entity Type (Digits 3 and 4)	Entity Subtype (Digits 5 and 6)	Code Note: The actual code is shown in bold numbers. The remaining numbers are used to show placement within the six digits.
	Government Leadership		110900
	Gray List Location		111000
	Mass Grave Site		111100
	Materiel		111200
	Mine		111300
	Missile and Space System Production		111400
	Nuclear (Non CBRN Defense)		111500
	Printed Media		111600
	Safe House		111700
	White List Location		111800
	Tented Camp		111900
		Displaced Persons/ Refugee/Evacuees Camp	111901
		Training Camp	111902
	Warehouse/Storage Facility		112000
	Law Enforcement		112100
		Bureau of Alcohol, Tobacco, Firearms and Explosives (ATF) (Department of Justice)	112101
		Border Patrol	112102
		Customs Service	112103
		Drug Enforcement Administration (DEA)	112104
		Department of Justice (DOJ)	112105
		Federal Bureau of Investigation (FBI)	112106
		Police	112107
		Prison	112108
		United States Secret Service (USSS)	112109
		Transportation Security Administration (TSA)	112110
		Coast Guard	112111
		US Marshals Service	112112
	Emergency Operation		112200
		Fire Station	112201
		Emergency Medical Operation	112202
Infrastructure			120000
	Agriculture and Food Infrastructure		120100
		Agriculture Laboratory	120101

MIL-STD-2525D - APPENDIX A

TABLE A-XXVII. Land installation entity/entity type/entity subtype - Continued.

Entity (Digits 1 and 2)	Entity Type (Digits 3 and 4)	Entity Subtype (Digits 5 and 6)	Code Note: The actual code is shown in bold numbers. The remaining numbers are used to show placement within the six digits.
		Animal Feedlot	1201 02
		Commercial Food Distribution Center	1201 03
		Farm/Ranch	1201 04
		Food Distribution	1201 05
		Food Production Center	1201 06
		Food Retail	1201 07
		Grain Storage	1201 08
	Banking Finance and Insurance Infrastructure		12 02 00
		ATM	1202 01
		Bank	1202 02
		Bullion Storage	1202 03
		Economic Infrastructure Asset	1202 04
		Federal Reserve Bank	1202 05
		Financial Exchange	1202 06
		Financial Services, Other	1202 07
	Commercial Infrastructure		12 03 00
		Chemical Plant	1203 01
		Firearms Manufacturer	1203 02
		Firearms Retailer	1203 03
		Hazardous Material Production	1203 04
		Hazardous Material Storage	1203 05
		Industrial Site	1203 06
		Landfill	1203 07
		Pharmaceutical Manufacturer	1203 08
		Contaminated Hazardous Waste Site	1203 09
		Toxic Release Inventory	1203 10
	Educational Facilities Infrastructure		12 04 00
		College/University	1204 01
		School	1204 02
	Energy Facility Infrastructure		12 05 00
		Electric Power	1205 01
		Generation Station	1205 02
		Natural Gas Facility	1205 03
		Petroleum Facility	1205 04
		Petroleum/Gas/Oil	1205 05
		Propane Facility	1205 06
	Government Site Infrastructure		12 06 00

MIL-STD-2525D - APPENDIX A

TABLE A-XXVII. Land installation entity/entity type/entity subtype - Continued.

Entity (Digits 1 and 2)	Entity Type (Digits 3 and 4)	Entity Subtype (Digits 5 and 6)	Code Note: The actual code is shown in bold numbers. The remaining numbers are used to show placement within the six digits.
	Medical Infrastructure		120700
		Medical	120701
		Medical Treatment Facility (Hospital)	120702
	Military Infrastructure		120800
		Military Armory	120801
		Military Base	120802
	Postal Services Infrastructure		120900
		Postal Distribution Center	120901
		Post Office	120902
	Public Venues Infrastructure		121000
		Enclosed Facility	121001
		Open Facility	121002
		Recreational Area	121003
		Religious Institution	121004
	Special Needs Infrastructure		121100
		Adult Day Care	121101
		Child Day Care	121102
		Elder Care	121103
	Telecommunications Infrastructure		121200
		Broadcast Transmitter Antennae	121201
		Telecommunications	121202
		Telecommunications Tower	121203
	Transportation Infrastructure		121300
		Airport/Air Base	121301
		Air Traffic Control Facility	121302
		Bus Station	121303
		Ferry Terminal	121304
		Helicopter Landing Site	121305
		Maintenance Facility	121306
		Railhead/Railroad Station	121307
		Rest Stop	121308
		Sea Port/Naval Base	121309
		Ship Yard	121310
		Toll Facility	121311
		Traffic Inspection Facility	121312
		Tunnel	121313
	Water Supply Infrastructure		121400
		Control Valve	121401
		Dam	121402

TABLE A-XXVII. Land installation entity/entity type/entity subtype - Continued.

Entity (Digits 1 and 2)	Entity Type (Digits 3 and 4)	Entity Subtype (Digits 5 and 6)	Code Note: The actual code is shown in bold numbers. The remaining numbers are used to show placement within the six digits.
		Discharge Outfall	1214 03
		Ground Water Well	1214 04
		Pumping Station	1214 05
		Reservoir	1214 06
		Storage Tower	1214 07
		Surface Water Intake	1214 08
		Wastewater Treatment Facility	1214 09
		Water	1214 10
		Water Treatment	1214 11

TABLE A-XXVIII. Land installation sector 1 modifier.

First Modifier	MIL-STD-2525D Code	Remarks.
Unspecified	00	
Biological	01	
Chemical	02	
Nuclear	03	
Radiological	04	
Decontamination	05	
Coal	06	Used with Electric Power
Geothermal	07	Used with Electric Power
Hydroelectric	08	Used with Electric Power
Natural Gas	09	Used with Electric Power
Petroleum	10	Used with Electric Power
Civilian	11	Operation
Civilian Telephone	12	Telecommunication
Civilian Television	13	Telecommunication
Reserved for Future Use	14-98	Assigned by SSMC/JSP only
Version Extension Flag	99	

TABLE A-XXIX. Land installation sector 2 modifier.

First Modifier	MIL-STD-2525D Code	Remarks.
Unspecified	00	
Biological	01	Used with CRBN
Chemical	02	Used with CRBN
Nuclear	03	Used with CRBN
Radiological	04	Used with CRBN
Atomic Energy Reactor	05	Used with CRBN
Nuclear Material Production	06	Used with CRBN

TABLE A-XXIX. Land installation sector 2 modifier - Continued.

Nuclear Material Storage	07	Used with CRBN
Weapons Grade	08	Used with CRBN
Reserved for Future Use	09-98	Assigned by SSMC/JSP only
Version Extension Flag	99	

A.5.4.9 Control measure (25).TABLE A-XXX. Control measure entity/entity type/entity subtype.

Entity (Digits 1 and 2)	Entity Type (Digits 3 and 4)	Entity Subtype (Digits 5 and 6)	Code Note: The actual code is shown in bold numbers. The remaining numbers are used to show placement within the six digits.
Command and Control Lines			110000
	Boundary		110100
		Lateral	110101
		Forward	110102
		Rear	110103
	Light Line		110200
Command and Control Areas			120000
	Area of Operations		120100
	Named Area of Interest		120200
	Targeted Area of Interest		120300
	Airfield Zone		120400
Command and Control Points			130000
	Unspecified Control Point		130100
	Amnesty Point		130200
	Checkpoint		130300
	Center of Main Effort		130400
	Contact Point		130500
	Coordinating Point		130600
	Decision Point		130700
	Distress Call		130800
	Entry Control Point		130900
	Fly-To-Point		131000
		Sonobuoy	131001
		Weapon	131002
		Normal	131003
	Linkup Point		131100
	Passage Point		131200

MIL-STD-2525D - APPENDIX A

TABLE A-XXX. Control measure entity/entity type/entity subtype - Continued.

Entity (Digits 1 and 2)	Entity Type (Digits 3 and 4)	Entity Subtype (Digits 5 and 6)	Code Note: The actual code is shown in bold numbers. The remaining numbers are used to show placement within the six digits.
	Point of Interest		131300
		Launch Event	131301
	Rally Point		131400
	Release Point		131500
	Start Point		131600
	Special Point		131700
	Waypoint		131800
	Airfield		131900
Maneuver Lines			140000
	Forward Line of Troops		140100
		Friendly Present	140101
		Friendly Planned or on Order	140102
		Enemy Known	140103
		Enemy Suspected or Templated	140104
	Line of Contact		140200
	Phase Line		140300
	Forward Edge of the Battle Area		140400
		Proposed or On Order	140401
	Principle Direction of Fire		140500
	Direction of Attack		140600
		Friendly Aviation	140601
		Friendly Main Attack /Decisive	140602
		Friendly Supporting Attack	140603
		Friendly Planned or On Order	140604
		Feint	140605
		Enemy Confirmed	140606
		Enemy Templated or Suspected	140607
	Final Coordination Line		140700
	Infiltration Lane		140800
	Limit of Advance		140900
	Line of Departure		141000
	Line of Departure/Line of Contact		141100
	Probable Line of Deployment		141200
	Airhead Line		141300
	Bridgehead Line		141400
	Holding Line		141500
	Release Line		141600
	Ambush		141700
Maneuver Areas			150000

MIL-STD-2525D - APPENDIX A

TABLE A-XXX. Control measure entity/entity type/entity subtype - Continued.

Entity (Digits 1 and 2)	Entity Type (Digits 3 and 4)	Entity Subtype (Digits 5 and 6)	Code Note: The actual code is shown in bold numbers. The remaining numbers are used to show placement within the six digits.
	Area		150100
		Friendly	150101
		Friendly Planned or On Order	150102
		Enemy Known or Confirmed	150103
		Enemy Suspected	150104
	Assembly Area		150200
	Occupied Assembly Area		150300
		Offset Unit	150301
		Offset Units	150302
	Proposed or On Order		150400
	Action Area		150500
		Joint Tactical Action Area (JTAA)	150501
		Submarine Action Area (SAA)	150502
		Submarine-Generated Action Area (SGAA)	150503
	Drop Zone		150600
	Extraction Zone		150700
	Landing Zone		150800
	Pick-Up Zone		150900
	Fortified Area		151000
	Limited Access Area		151100
	Battle Position		151200
		Planned	151201
		Prepared (P) but not Occupied	151202
		Strong Point	151203
		Contain	151204
		Retain	151205
	Engagement Area (EA)		151300
	Axis of Advance		151400
		Friendly Airborne/Aviation	151401
		Attack Helicopter	151402
		Main Attack	151403
		Supporting Attack	151404
		Supporting Attack Planned or On Order	151405
		Feint	151406
		Enemy Confirmed	151407
		Enemy Templated or Suspected	151408
	Assault Position		151500
	Attack Position		151600

TABLE A-XXX. Control measure entity/entity type/entity subtype - Continued.

Entity (Digits 1 and 2)	Entity Type (Digits 3 and 4)	Entity Subtype (Digits 5 and 6)	Code Note: The actual code is shown in bold numbers. The remaining numbers are used to show placement within the six digits.
	Objective		151700
	Encirclement		151800
		Friendly	151801
		Enemy	151802
	Penetration Box		151900
	Attack by Fire Position		152000
	Support by Fire		152100
	Search Area/Reconnaissance Area		152200
Maneuver Points			160000
	Observation Post/Outpost (unspecified)		160100
	Observation Post/Outpost (specified)		160200
		Reconnaissance Outpost	160201
		Forward Observer Outpost	160202
		CBRN Observation Outpost	160203
		Sensor Outpost /Listening Post	160204
		Combat Outpost	160205
	Target Reference Point		160300
	Point of Departure		160400
Airspace Control (Corridors) Areas			170000
	Air Corridor		170100
		With Multiple Segments	170101
	Low Level Transit Route		170200
	Minimum-Risk Route		170300
	Safe Lane		170400
	Standard Use Army Aircraft Flight Route		170500
	Transit Corridor		170600
	Unmanned Aircraft (UA) Route		170700
	Base Defense Zone		170800
	High-Density Airspace Control Zone		170900
	Restricted Operations Zone		171000
	Air-to-Air Restricted Operating Zone		171100
	Unmanned Aircraft Restricted Operating Zone		171200
	Weapon Engagement Zone		171300

TABLE A-XXX. Control measure entity/entity type/entity subtype - Continued.

Entity (Digits 1 and 2)	Entity Type (Digits 3 and 4)	Entity Subtype (Digits 5 and 6)	Code Note: The actual code is shown in bold numbers. The remaining numbers are used to show placement within the six digits.
	Fighter Engagement Zone		17 1400
	Joint Engagement Zone		17 1500
	Missile Engagement Zone		17 1600
	Low Altitude Missile Engagement Zone		17 1700
	High Altitude Missile Engagement Zone		17 1800
	Short Range Air Defense Engagement Zone		17 1900
	Weapons Free Zone		17 2000
Airspace Control Points			180000
	Air Control Point		180100
	Communications Checkpoint		180200
	Downed Aircraft Pick-up Point		180300
	Pop-up Point		180400
	Air Control Rendezvous		180500
	Tactical Air Navigation (TACAN)		180600
	Combat Air Patrol (CAP) Station		180700
	Airborne Early Warning (AEW) Station		180800
	ASW (Helo and F/W) Station		180900
	Strike Initial Point		181000
	Replenishment Station		181100
	Tanking		181200
	Antisubmarine Warfare, Rotary Wing		181300
	Surface Combat Air Patrol (SUCAP)– Fixed Wing		181400
	SUCAP – Rotary Wing		181500
	MIW – Fixed Wing		181600
	MIW – Rotary Wing		181700
	Tomcat		181800
	Rescue		181900
	Unmanned Aerial System (UAS/UA)		182000
	Vertical Takeoff and Landing (VTOL) Tactical Unmanned Aircraft (VTUA)		182100
	Orbit		182200
	Orbit – Figure Eight		182300

TABLE A-XXX. Control measure entity/entity type/entity subtype - Continued.

Entity (Digits 1 and 2)	Entity Type (Digits 3 and 4)	Entity Subtype (Digits 5 and 6)	Code Note: The actual code is shown in bold numbers. The remaining numbers are used to show placement within the six digits.
	Orbit – Race Track		182400
	Orbit – Random Closed		182500
Airspace Control Lines			190000
	Identification Friend or Foe Off Line		190100
	Identification Friend or Foe On Line		190200
Maritime Control Areas			200000
	Launch Area		200100
		Ellipse/Circle	200101
	Defended Area		200200
		Ellipse/Circle	200201
		Rectangle	200202
	No Attack (NOTACK) Zone		200300
	Ship Area of Interest		200400
		Ellipse/Circle	200401
		Rectangle	200402
	Active Maneuver Area		200500
	Cued Acquisition Doctrine		200600
	Radar Search Doctrine		200700
Maritime Control Points			210000
	Plan Ship		210100
	Aim Point		210200
	Defended Asset		210300
	Drop Point		210400
	Entry Point		210500
	Air Detonation		210600
	Ground Zero		210700
	Impact Point		210800
	Predicted Impact Point		210900
	Launched Torpedo		211000
	Missile Detection Point		211100
	Acoustic Countermeasure (Decoy)		211200
	Electronic Countermeasures (ECM) Decoy		211300
	Brief Contact		211400
	Datum Lost Contact		211500

TABLE A-XXX. Control measure entity/entity type/entity subtype - Continued.

Entity (Digits 1 and 2)	Entity Type (Digits 3 and 4)	Entity Subtype (Digits 5 and 6)	Code Note: The actual code is shown in bold numbers. The remaining numbers are used to show placement within the six digits.
	BT Buoy Drop		21 1600
	Reported Bottomed Sub		21 1700
	Moving Haven		21 1800
	Screen Center		21 1900
	Lost Contact		21 2000
	Sinker		21 2100
	Trial Track		21 2200
	Acoustic Fix		21 2300
	Electromagnetic Fix		21 2400
	Electromagnetic – Magnetic Anomaly Detection (MAD)		21 2500
	Optical Fix		21 2600
	Formation		21 2700
	Harbor		21 2800
	Harbor Entrance Point		21 2900
		A	2129 01
		Q	2129 02
		X	2129 03
		Y	2129 04
	Dip Position		21 3000
	Search		21 3100
	Search Area		21 3200
	Search Center		21 3300
	Navigational Reference Point		21 3400
	Sonobuoy		21 3500
		Ambient Noise	2135 01
		Air Transportable Communication	2135 02
		Barra	2135 03
		Bathythermograph Transmitting	2135 04
		Command Active Multi-Beam (CAMBS)	2135 05
		Command Active Sonobuoy Directional Command Active Sonobuoy System (CASS)	2135 06
		Directional Frequency Analysis and Recording (DIFAR)	2135 07
		Directional Command Active Sonobuoy System (DICASS)	2135 08
		Expendable Reliable Acoustic Path Sonobuoy (ERAPS)	2135 09

MIL-STD-2525D - APPENDIX A

TABLE A-XXX. Control measure entity/entity type/entity subtype - Continued.

Entity (Digits 1 and 2)	Entity Type (Digits 3 and 4)	Entity Subtype (Digits 5 and 6)	Code Note: The actual code is shown in bold numbers. The remaining numbers are used to show placement within the six digits.
		Expired	2135 10
		Kingpin	2135 11
		Low Frequency Analysis and Recording (LOFAR)	2135 12
		Pattern Center	2135 13
		Range Only	2135 14
		Vertical Line Array Directional Frequency Analysis and Recording (DIFAR)	2135 15
	Reference Point		213 600
	Special Point		213 700
	Navigational Reference Point(Points)		213 800
	Data Link Reference Point		213 900
	Forward Observer / Spotter Position		214 000
	Vital Area Center		214 100
	Corridor Tab Point		214 200
	Enemy Point		214 300
	Marshall Point		214 400
	Position and Intended Movement (PIM)		214 500
	Pre-Landfall Waypoint		214 600
	Estimated Position (EP)		214 700
	Waypoint		214 800
	General Subsurface Station		214 900
	Submarine Subsurface Station		215 000
	Submarine Antisubmarine Warfare Subsurface Station		215 100
	Unmanned Underwater Vehicle Subsurface Station		215 200
	Antisubmarine Warfare (ASW) Unmanned Underwater Vehicle Subsurface Station		215 300
	Mine Warfare Unmanned Underwater Vehicle Subsurface Station		215 400
	Surface Warfare Unmanned Underwater Vehicle Subsurface Station		215 500
	General Surface Station		215 600

TABLE A-XXX. Control measure entity/entity type/entity subtype - Continued.

Entity (Digits 1 and 2)	Entity Type (Digits 3 and 4)	Entity Subtype (Digits 5 and 6)	Code Note: The actual code is shown in bold numbers. The remaining numbers are used to show placement within the six digits.
	Antisubmarine Warfare (ASW) Surface Station		21 5 700
	Mine Warfare Surface Station		21 5 800
	Non-Combatant Surface Station		21 5 900
	Picket Surface Station		21 6 000
	Rendezvous Surface Station		21 6 100
	Replenishment at Sea Surface Station		21 6 200
	Rescue Surface Station		21 6 300
	Surface Warfare Surface Station		21 6 400
	Unmanned Underwater Vehicle Surface Station		21 6 500
	Antisubmarine Warfare (ASW) Unmanned Underwater Vehicle Surface Station		21 6 600
	Mine Warfare Unmanned Underwater Vehicle Surface Station		21 6 700
	Remote Multi-Mission Vehicle Mine Warfare Unmanned Underwater Surface Station		21 6 800
	Surface Warfare Mine Warfare Unmanned Underwater Vehicle Surface Station		21 6 900
	Shore Control Station		21 7 000
	General Route		21 7 100
	Diversion Route		21 7 200
	Position and Intended Movement (PIM) Route		21 7 300
	Picket Route		21 7 400
	Point R Route		21 7 500
	Rendezvous Route		21 7 600
	Waypoint Route		21 7 700
	Clutter, Stationary or Cease Reporting		21 7 800
	Tentative or Provisional Track		21 7 900
	Distressed Vessel		21 8 000
	Ditched Aircraft/Downed Aircraft		21 8 100
	Person in Water/Bailout		21 8 200
	Iceberg		21 8 300
	Navigational		21 8 400

MIL-STD-2525D - APPENDIX A

TABLE A-XXX. Control measure entity/entity type/entity subtype - Continued.

Entity (Digits 1 and 2)	Entity Type (Digits 3 and 4)	Entity Subtype (Digits 5 and 6)	Code Note: The actual code is shown in bold numbers. The remaining numbers are used to show placement within the six digits.
	Oil Rig		21 8 500
	Sea Mine-Like		21 8 600
	Bottom Return/Non-Mine, Mine-Like Bottom Object (NOMBO)		21 8 700
	Bottom Return/Non-Mine, Mine-Like Bottom Object (NOMBO)/Installation Manmade		21 8 800
		Marine Life	21 8 900
		Sea Anomaly (Wake, Current, Knuckle)	21 9 000
		Bottom Return/Non-MILCO, Wreck, Dangerous	21 9 100
		Bottom Return/Non-MILCO, Wreck, Non Dangerous	21 9 200
Maritime Control Lines			22 0000
	Bearing Line		22 0 100
		Electronic	22 0 1 0 1
		Electronic Warfare (EW)	22 0 1 0 2
		Acoustic	22 0 1 0 3
		Acoustic (Ambiguous)	22 0 1 0 4
		Torpedo	22 0 1 0 5
		Electro-Optical Intercept	22 0 1 0 6
		Jammer	22 0 1 0 7
		Radio Direction Finder (RDF)	22 0 1 0 8
Deception			23 0000
	Decoy/Dummy		23 0 100
	Decoy/Dummy/Feint		23 0 200
Fires Areas			24 0000
	Airspace Coordination Area		24 0 100
		Irregular	24 0 1 0 1
		Rectangular	24 0 1 0 2
		Circular	24 0 1 0 3
	Free Fire Area		24 0 200
		Irregular	24 0 2 0 1
		Rectangular	24 0 2 0 2
		Circular	24 0 2 0 3
	No Fire Area		24 0 300
		Irregular	24 0 3 0 1
		Rectangular	24 0 3 0 2
		Circular	24 0 3 0 3

MIL-STD-2525D - APPENDIX A

TABLE A-XXX. Control measure entity/entity type/entity subtype - Continued.

Entity (Digits 1 and 2)	Entity Type (Digits 3 and 4)	Entity Subtype (Digits 5 and 6)	Code Note: The actual code is shown in bold numbers. The remaining numbers are used to show placement within the six digits.
	Restricted Fire Area		240400
		Irregular	240401
		Rectangular	240402
		Circular	240403
	Position Area For Artillery (PAA)		240500
		Rectangular	240501
		Circular	240502
	Point Targets		240600
		Point or Single Target	240601
		Nuclear Target	240602
		Target-Recorded	240603
	Linear Targets		240700
		Linear Target	240701
		Linear Smoke Target	240702
		Final Protective Fire (FPF)	240703
	Area Targets		240800
		Area Target	240801
		Rectangular Target	240802
		Circular Target	240803
		Rectangular Target – Single Target	240804
		Series or Groups of Targets	240805
		Smoke	240806
		Smoke Planned or On Order	240807
		Bomb Area	240808
	Fire Support Station		240900
	Fire Support Area		241000
		Irregular	241001
		Rectangular	241002
		Circular	241003
	Artillery Target Intelligence Zone		241100
		Irregular	241101
		Rectangular	241102
		Circular	241103
	Call for Fire Area		241200
		Irregular	241201
		Rectangular	241202
		Circular	241203
	Censor Area		241300

MIL-STD-2525D - APPENDIX A

TABLE A-XXX. Control measure entity/entity type/entity subtype - Continued.

Entity (Digits 1 and 2)	Entity Type (Digits 3 and 4)	Entity Subtype (Digits 5 and 6)	Code Note: The actual code is shown in bold numbers. The remaining numbers are used to show placement within the six digits.
		Irregular	2413 01
		Rectangular	2413 02
		Circular	2413 03
	Critical Friendly Area		2414 00
		Irregular	2414 01
		Rectangular	2414 02
		Circular	2414 03
	Dead Space Area		2415 00
		Irregular	2415 01
		Rectangular	2415 02
		Circular	2415 03
	Sensor Area		2416 00
		Irregular	2416 01
		Rectangular	2416 02
		Circular	2416 03
	Target Build-up Area		2417 00
		Irregular	2417 01
		Rectangular	2417 02
		Circular	2417 03
	Target Value Area		2418 00
		Irregular	2418 01
		Rectangular	2418 02
		Circular	2418 03
	Zone of Responsibility		2419 00
		Irregular	2419 01
		Rectangular	2419 02
		Circular	2419 03
	Terminally Guided Munition Footprint (TGMF)		242 000
	Weapon/Sensor Range fan, Circular		242 100
	Weapon/Sensor Range fan, Sector		242 200
	Kill Box		242 300
		Irregular, Blue	2423 01
		Rectangular, Blue	2423 02
		Circular, Blue	2423 03
		Irregular, Purple	2423 04
		Rectangular, Purple	2423 05
		Circular, Purple	2423 06

TABLE A-XXX. Control measure entity/entity type/entity subtype - Continued.

Entity (Digits 1 and 2)	Entity Type (Digits 3 and 4)	Entity Subtype (Digits 5 and 6)	Code Note: The actual code is shown in bold numbers. The remaining numbers are used to show placement within the six digits.
Fires Points			250000
	Firing Point		250100
	Hide Point		250200
	Launch Point		250300
	Reload Point		250400
	Survey Control Point		250500
Fire Lines			260000
	Fire Support Coordination Line (FSCL)		260100
	Coordinated Fire Line (CFL)		260200
	No Fire Line		260300
	Battlefield Coordination Line		260400
	Restrictive Fire Line		260500
	Munition Flight Path		260600
Protection Areas			270000
	Obstacle Belt		270100
	Obstacle Zone		270200
	Obstacle Free Zone		270300
	Obstacle Restricted Zone		270400
	Obstacle Effects		270500
		Block	270501
		Disrupt	270502
		Fix	270503
		Turn	270504
	Obstacle Bypass		270600
		Easy	270601
		Difficult	270602
		Impossible	270603
	Minefield		270700
		Completed	270701
		Planned	270702
		Known Enemy	270703
		Suspected or Templated Enemy	270704
		Dummy	270705
		Dummy Dynamic	270706
		Dynamic Depiction	270707
	Mined Area		270800
	Decoy Mined Area		270900
		Fenced	270901

TABLE A-XXX. Control measure entity/entity type/entity subtype - Continued.

Entity (Digits 1 and 2)	Entity Type (Digits 3 and 4)	Entity Subtype (Digits 5 and 6)	Code Note: The actual code is shown in bold numbers. The remaining numbers are used to show placement within the six digits.
	Unexploded Explosive Ordnance (UXO) Area		271000
	Bridge or Gap		271100
	Roadblocks, Craters and Blown Bridges		271200
		Planned	271201
		Explosives, State of Readiness 1 (Safe)	271202
		Explosives, State of Readiness 2 (armed but passable)	271203
		Roadblock Complete (Executed)	271204
	Assault Crossing		271300
	Bridge		271400
	Ford Easy		271500
	Ford Difficult		271600
	Biological Contaminated Area		271700
		Toxic Industrial Material	271701
	Chemical Contaminated Area		271800
		Toxic Industrial Material	271801
	Nuclear Contaminated Area		271900
	Radiological Contaminated Area		272000
		Toxic Industrial Material	272001
	Minimum Safe Distance Zone		272100
	Radiation Dose Rate Contour Lines		272200
Protection Points			280000
	Abatis		280100
	Antipersonnel Mine		280200
		Antipersonnel Mine with Directional Effects	280201
	Antitank Mine		280300
	Antitank Mine with Anti-handling Device		280400
	Wide Area Antitank Mine		280500
	Unspecified Mine		280600
	Booby Trap		280700
	Engineer Regulating Point		280800
	Shelter		280900
	Shelter Above Ground		281000
	Below Ground Shelter		281100
	Fort		281200

TABLE A-XXX. Control measure entity/entity type/entity subtype - Continued.

Entity (Digits 1 and 2)	Entity Type (Digits 3 and 4)	Entity Subtype (Digits 5 and 6)	Code Note: The actual code is shown in bold numbers. The remaining numbers are used to show placement within the six digits.
	Chemical Event		281300
		Toxic Industrial Material	281301
	Biological Event		281400
		Toxic Industrial Material	281401
	Nuclear Event		281500
	Nuclear Fallout Producing Event		281600
	Radiological		281700
		Toxic Industrial Material	281701
	General Decontamination Point/Site		281800
		Alternate	281801
		Equipment	281802
		Troop	281803
		Equipment/Troop	281804
		Operational	281805
		Thorough	281806
		Main Equipment	281807
		Forward Troop	281808
		Wounded Personnel	281809
	Tetrahedrons, Dragons Teeth, and Other Similar Obstacles		281900
		Fixed and Prefabricated	281901
		Movable	281902
		Movable and Prefabricated	281903
	Vertical Obstructions		282000
		Tower, Low	282001
		Tower, High	282002
		Overhead Wire	282003
Protection Lines			290000
	Obstacle Line		290100
	Antitank Obstacles		290200
		Under Construction	290201
		Completed	290202
		Reinforced, with Antitank Mines	290203
		Antitank Wall	290204
	Wire Obstacles		290300
		Unspecified Wire	290301
		Single Fence Wire	290302
		Double Fence Wire	290303

TABLE A-XXX. Control measure entity/entity type/entity subtype - Continued.

Entity (Digits 1 and 2)	Entity Type (Digits 3 and 4)	Entity Subtype (Digits 5 and 6)	Code Note: The actual code is shown in bold numbers. The remaining numbers are used to show placement within the six digits.
		Double Apron Fence	2903 04
		Low Wire Fence	2903 05
		High Wire Fence	2903 06
		Single Concertina	2903 07
		Double Strand Concertina	2903 08
		Triple Strand Concertina	2903 09
	Mine Cluster		29 04 00
	Trip Wire		29 05 00
	Lane		29 06 00
	Ferry		29 07 00
	Raft Site		29 08 00
	Fortified Line		29 09 00
	Fortified Position		29 10 00
Intelligence Lines			300000
	Intelligence Coordination Line		300100
Sustainment Areas			310000
	Detainee Holding Area		310100
	Enemy Prisoner or War Holding Area		310200
	Forward Arming and Refueling Point		310300
	Refugee Holding Area		310400
	Regimental Support Area		310500
	Brigade Support Area		310600
	Division Support Area		310700
Sustainment Points			320000
	Ambulance Exchange Point		320100
	Ammunition Supply Point		320200
	Ammunition Transfer Point		320310
	Cannibalization Point		320400
	Casualty Collection Point		320500
	Civilian Collection Point		320600
	Detainee Collection Point		320700
	Enemy Prisoner of War Collection Point		320800
	Logistics Release Point		320900
	Maintenance Collection Point (MCP)		321000
	Medical Evacuation Point (MEDEVAC) Pick-Up Point		321100

TABLE A-XXX. Control measure entity/entity type/entity subtype - Continued.

Entity (Digits 1 and 2)	Entity Type (Digits 3 and 4)	Entity Subtype (Digits 5 and 6)	Code Note: The actual code is shown in bold numbers. The remaining numbers are used to show placement within the six digits.
	Rearm, Refuel and Resupply Point (R3P)		321200
	Refuel on the Move (ROM) Point		321300
	Traffic Control Post (TCP)		321400
	Trailer Transfer Point (TTP)		321500
	Unit Maintenance Collection Point (UNCP)		321600
	General Supply Point		321700
		NATO Class I Supply Point	321701
		NATO Class II Supply Point	321702
		NATO Class III Supply Point	321703
		NATO Class IV Supply Point	321704
		NATO Class V Supply Point	321705
		NATO Multiple Class Supply Point	321706
		US Class I Supply Point	321707
		US Class II Supply Point	321708
		US Class III Supply Point	321709
		US Class IV Supply Point	321710
		US Class V Supply Point	321711
		US Class VI Supply Point	321712
		US Class VII Supply Point	321713
		US Class VIII Supply Point	321714
		US Class IX Supply Point	321715
		US Class X Supply Point	321716
	Medical Supply Point		321800
Sustainment Lines			330000
	Moving Convoy		330100
	Halted Convoy		330200
	Main Supply Route		330300
		One Way Traffic	330301
		Two Way Traffic	330302
		Alternating Traffic	330303
	Alternate Supply Route		330400
		One Way Traffic	330401
		Two Way Traffic	330402
		Alternating Traffic	330403
Mission Tasks			340000
	Block		340100
	Breach		340200

TABLE A-XXX. Control measure entity/entity type/entity subtype - Continued.

Entity (Digits 1 and 2)	Entity Type (Digits 3 and 4)	Entity Subtype (Digits 5 and 6)	Code Note: The actual code is shown in bold numbers. The remaining numbers are used to show placement within the six digits.
	Bypass		34 0300
	Canalize		34 0400
	Clear		34 0500
	Counterattack		34 0600
	Counterattack by Fire		34 0700
	Delay		34 0800
	Destroy		34 0900
	Disrupt		34 1000
	Fix		34 1100
	Follow and Assume		34 1200
	Follow and Support		34 1300
	Interdict		34 1400
	Isolate		34 1500
	Neutralize		34 1600
	Occupy		34 1700
	Penetrate		34 1800
	Relief in Place (RIP)		34 1900
	Retire/Retirement		34 2000
	Secure		34 2100
	Security		34 2200
		Cover	3422 01
		Guard	3422 02
		Screen	3422 03
	Seize		34 2300
	Withdraw		34 2400
	Withdraw Under Pressure		34 2500

A.5.4.10 Sea surface (30).TABLE A-XXXI. Sea surface entity/entity type/entity subtype.

Entity (Digits 1 and 2)	Entity Type (Digits 3 and 4)	Entity Subtype (Digits 5 and 6)	Code Note: The actual code is shown in bold numbers. The remaining numbers are used to show placement within the six digits.
Military			110000
Military Combatant			120000

TABLE A-XXXI. Sea surface entity/entity type/entity subtype - Continued.

Entity (Digits 1 and 2)	Entity Type (Digits 3 and 4)	Entity Subtype (Digits 5 and 6)	Code Note: The actual code is shown in bold numbers. The remaining numbers are used to show placement within the six digits.
	Carrier		12 0100
	Surface Combatant, Line		12 0200
		Battleship	1202 01
		Cruiser	1202 02
		Destroyer	1202 03
		Frigate	1202 04
		Corvette	1202 05
		Littoral Combatant Ship	1202 06
	Amphibious Warfare Ship		12 0300
		Amphibious Command Ship	1203 01
		Amphibious Assault, Non-specified	1203 02
		Amphibious Assault Ship, General	1203 03
		Amphibious Assault Ship, Multipurpose	1203 04
		Amphibious Assault Ship, Helicopter	1203 05
		Amphibious Transport Dock	1203 06
		Landing Ship	1203 07
		Landing Craft	1203 08
	Mine Warfare Ship		12 0400
		Mine Layer	1204 01
		Mine Sweeper	1204 02
		Mine Sweeper, Drone	1204 03
		Mine Hunter	1204 04
		Mine Countermeasures	1204 05
		Mine Countermeasures, Support Ship	1204 06
	Patrol Boat		12 0500
		Patrol Craft, Submarine Chaser/Escort, General	1205 01
		Patrol Ship, General	1205 02
	Decoy		12 0600
	Unmanned Surface Water Vehicle (USV)		12 0700
	Speedboat		12 0800
		Rigid-Hull Inflatable Boat (RHIB)	1208 01
	Jet Ski		12 0900
	Navy Task Organization		12 1000
		Navy Task Element	1210 01
		Navy Task Force	1210 02
		Navy Task Group	1210 03
		Navy Task Unit	1210 04

MIL-STD-2525D - APPENDIX A

TABLE A-XXXI. Sea surface entity/entity type/entity subtype - Continued.

Entity (Digits 1 and 2)	Entity Type (Digits 3 and 4)	Entity Subtype (Digits 5 and 6)	Code Note: The actual code is shown in bold numbers. The remaining numbers are used to show placement within the six digits.
		Convoy	121 005
	Sea-Based X-Band Radar		121 100
Military Non Combatant			130000
	Auxiliary Ship		130 100
		Ammunition Ship	130 101
		Naval Stores Ship	130 102
		Auxiliary Flag Ship	130 103
		Intelligence Collector	130 104
		Oceanographic Research Ship	130 105
		Survey Ship	130 106
		Hospital Ship	130 107
		Naval Cargo Ship	130 108
		Combat Support Ship, Fast	130 109
		Oiler, Replenishment	130 110
		Repair Ship	130 111
		Submarine Tender	130 112
		Tug, Ocean Going	130 113
	Service Craft/Yard		130 200
		Barge, not Self-Propelled	130 201
		Barge, Self-Propelled	130 202
		Tug, Harbor	130 203
		Launch	130 204
Civilian			140000
	Merchant Ship		140 100
		Cargo, General	140 101
		Container Ship	140 102
		Dredge	140 103
		Roll On/Roll Off	140 104
		Ferry	140 105
		Heavy Lift	140 106
		Hovercraft	140 107
		Lash Carrier (with Barges)	140 108
		Oiler/Tanker	140 109
		Passenger	140 110
		Tug, Ocean Going	140 111
		Tow	140 112
		Transport Ship, Hazardous Material	140 113
		Junk/Dhwo	140 114

MIL-STD-2525D - APPENDIX A

TABLE A-XXXI. Sea surface entity/entity type/entity subtype - Continued.

Entity (Digits 1 and 2)	Entity Type (Digits 3 and 4)	Entity Subtype (Digits 5 and 6)	Code Note: The actual code is shown in bold numbers. The remaining numbers are used to show placement within the six digits.
		Barge, not Self-Propelled	1401 15
		Hospital Ship	1401 16
	Fishing Vessel		140 200
		Drifter	140 201
		Trawler	140 202
		Dredger	140 203
	Law Enforcement Vessel		140 300
	Leisure Craft, Sailing		140 400
	Leisure Craft, Motorized		140 500
		Rigid-Hull Inflatable Boat (RHIB)	140 501
		Speedboat	140 502
	Jet Ski		140 600
	Unmanned Surface Water Vehicle (USV)		140 700
Own Ship			150000
Fused Track			160000
Manual Track			170000

TABLE A-XXXII. Sea surface sector 1 modifier.

First Modifier	MIL-STD-2525D Code	Remarks.
Unspecified	00	
Own Ship	01	APP6
Antiair Warfare	02	
Antisubmarine Warfare	03	
Escort	04	
Electronic Warfare	05	
Intelligence, Surveillance, Reconnaissance	06	
Mine Countermeasures	07	
Missile Defense	08	
Medical	09	
Mine Warfare	10	
Remote Multi-Mission Vehicle (USV-only)	11	
Special Operations Forces (SOF)	12	
Surface Warfare	13	
Ballistic Missile	14	
Guided Missile	15	
Other Guided Missile	16	
Torpedo	17	
Drone-Equipped	18	
Helicopter-Equipped/VSTOL	19	

TABLE A-XXXI. Sea surface entity/entity type/entity subtype - Continued.

Entity (Digits 1 and 2)	Entity Type (Digits 3 and 4)	Entity Subtype (Digits 5 and 6)	Code Note: The actual code is shown in bold numbers. The remaining numbers are used to show placement within the six digits.
Ballistic Missile Defense, Shooter		20	
Ballistic Missile Defense, Long-Range Surveillance and Track (LRS&T)		21	
Sea-Base X-Band		22	
Hijacking		23	
Reserved for Future Use		24-98	Assigned by SSMC/JSP only
Version Extension Flag		99	

TABLE A-XXXIII. Sea surface sector 2 modifier.

Second Modifier	MIL-STD-2525D Code	Remarks.
Unspecified	00	
Nuclear Powered	01	
Heavy	02	
Light	03	
Medium	04	
Dock	05	
Logistics	06	
Tank	07	
Vehicle	08	
Fast	09	
Air-Cushioned (US)	10	
Air-Cushioned (NATO)	11	
Hydrofoil	12	
Autonomous Control	13	
Remotely Piloted	14	
Expendable	15	
Reserved for Future Use	16-98	Assigned by SSMC/JSP only
Version Extension Flag	99	

A.5.4.11 Sea subsurface (35).

TABLE A-XXXIV. Sea Subsurface entity/entity type/entity subtype.

Entity (Digits 1 and 2)	Entity Type (Digits 3 and 4)	Entity Subtype (Digits 5 and 6)	Code Note: The actual code is shown in bold numbers. The remaining numbers are used to show placement within the six digits.
Military			110000
	Submarine		110100

TABLE A-XXXIV. Sea Subsurface entity/entity type/entity subtype - Continued.

Entity (Digits 1 and 2)	Entity Type (Digits 3 and 4)	Entity Subtype (Digits 5 and 6)	Code Note: The actual code is shown in bold numbers. The remaining numbers are used to show placement within the six digits.
		Submarine, Surfaced	110101
		Submarine, Snorkeling	110102
		Submarine, Bottomed	110103
	Other Submersible		110200
	Nonsubmarine		110300
	Autonomous Underwater Vehicle (AUV)/Unmanned Underwater Vehicle (UUV)		110400
	Diver		110500
Civilian			120000
	Submersible		120100
	Autonomous Underwater Vehicle (AUV)/ Unmanned Underwater Vehicle (UUV)		120200
	Diver		120300
Weapon			130000
	Torpedo		130100
	Improvised Explosive Device (IED)		130200
	Decoy		130300
Echo Tracker Classifier (ETC) / Possible Contact (POSCON)			140000
Fused Track			150000
Manual Track			160000

TABLE A-XXXV. Sea subsurface sector 1 modifier.

First Modifier	MIL-STD-2525D Code	Remarks.
Unspecified	00	
Antisubmarine Warfare	01	
Auxiliary	02	
Command and Control	03	
Intelligence, Surveillance, Reconnaissance	04	
Mine Countermeasures	05	
Mine Warfare	06	
Surface Warfare	07	
Attack	08	
Ballistic Missile	09	
Guided Missile	10	

MIL-STD-2525D - APPENDIX A

TABLE A-XXXV. Sea subsurface sector 1 modifier - Continued.

First Modifier	MIL-STD-2525D Code	Remarks.
Other Guided Missile	11	
Special Operations Forces (SOF)	12	
Possible Submarine Low 1	13	
Possible Submarine Low 2	14	
Possible Submarine High 3	15	
Possible Submarine High 4	16	
Probable Submarine	17	
Certain Submarine	18	
Anti-torpedo Torpedo	19	
Hijacking/Highjacked	20	
Reserved for Future Use	21-98	Assigned by SSMC/JSP only
Version Extension Flag	99	

TABLE A-XXXVI. Sea subsurface sector 2 modifier.

Second Modifier	MIL-STD-2525D Code	Remarks.
Unspecified	00	
Air Independent Propulsion	01	
Diesel Electric, General	02	
Diesel – Type 1	03	
Diesel – Type 2	04	
Diesel – Type 3	05	
Nuclear Powered, General	06	
Nuclear – Type 1	07	
Nuclear – Type 2	08	
Nuclear – Type 3	09	
Nuclear – Type 4	10	
Nuclear – Type 5	11	
Nuclear – Type 6	12	
Nuclear – Type 7	13	
Autonomous Control	14	
Remotely Piloted	15	
Expendable	16	
Reserved for Future Use	17-98	Assigned by SSMC/JSP only
Version Extension Flag	99	

A.5.4.12 Mine warfare (36).

TABLE A-XXXVII. Mine warfare entity/entity type/entity subtype.

Entity (Digits 1 and 2)	Entity Type (Digits 3 and 4)	Entity Subtype (Digits 5 and 6)	Code Note: The actual code is shown in bold numbers. The remaining numbers are used to show placement within the six digits.
Sea Mine, General			110000
	Sea Mine, Bottom		110100
	Sea Mine, Moored		110200
	Sea Mine, Floating		110300
	Sea Mine, Rising		110400
	Sea Mine, Other Position		110500
	Kingfisher		110600
	Small Object, Mine-Like		110700
	Exercise Mine, General		110800
		Exercise Mine, Bottom	110801
		Exercise Mine, Moored	110802
		Exercise Mine, Floating	110803
		Exercise Mine, Rising	110804
	Neutralized Mine, General		110900
		Neutralized Mine, Bottom	110901
		Neutralized Mine, Moored	110902
		Neutralized Mine, Floating	110903
		Neutralized Mine, Rising	110904
		Neutralized Mine, Other Position	110905
Unexploded Ordnance			120000
Sea Mine Decoy			130000
	Sea Mine Decoy, Bottom		130100
	Sea Mine Decoy, Moored		130200
Mine-Like Contact (MILCO)			140000
	MILCO - General		140100
		MILCO - General, Confidence Level 1	140101
		MILCO - General, Confidence Level 2	140102
		MILCO - General, Confidence Level 3	140103
		MILCO - General, Confidence Level 4	140104
		MILCO - General, Confidence Level 5	140105
	MILCO - Bottom		140200

MIL-STD-2525D - APPENDIX A

TABLE A-XXXVII. Mine warfare entity/entity type/entity subtype.

Entity (Digits 1 and 2)	Entity Type (Digits 3 and 4)	Entity Subtype (Digits 5 and 6)	Code Note: The actual code is shown in bold numbers. The remaining numbers are used to show placement within the six digits.
		MILCO - Bottom, Confidence Level 1	1402 01
		MILCO - Bottom, Confidence Level 2	1402 02
		MILCO - Bottom, Confidence Level 3	1402 03
		MILCO - Bottom, Confidence Level 4	1402 04
		MILCO - Bottom, Confidence Level 5	1402 05
	MILCO - Moored		140 300
		MILCO - Moored, Confidence Level 1	140 301
		MILCO - Moored, Confidence Level 2	140 302
		MILCO - Moored, Confidence Level 3	140 303
		MILCO - Moored, Confidence Level 4	140 304
		MILCO - Moored, Confidence Level 5	140 305
	MILCO - Floating		140 400
		MILCO - Floating, Confidence Level 1	140 401
		MILCO - Floating, Confidence Level 2	140 402
		MILCO - Floating, Confidence Level 3	140 403
		MILCO - Floating, Confidence Level 4	140 404
		MILCO - Floating, Confidence Level 5	140 405
Mine-Like Echo (MILEC), General			150000
	Mine-Like Echo, Bottom		150100
	Mine-Like Echo, Moored		150200
	Mine-Like Echo, Floating		150300
Negative Reacquisition, General			160000
	Negative Reacquisition, Bottom		160100
	Negative Reacquisition, Moored		160200
	Negative Reacquisition, Floating		160300

TABLE A-XXXVII. Mine warfare entity/entity type/entity subtype.

Entity (Digits 1 and 2)	Entity Type (Digits 3 and 4)	Entity Subtype (Digits 5 and 6)	Code Note: The actual code is shown in bold numbers. The remaining numbers are used to show placement within the six digits.
Obstructor			170000
	Neutralized Obstructor		170100
General Mine Anchor			180000
Non-Mine Mine-Like Object (NMLO), General			190000
	Non-Mine Mine-Like Object, Bottom		190100
	Non-Mine Mine-Like Object, Moored		190200
	Non-Mine Mine-Like Object, Floating		190300
Environmental Report Location			200000
Dive Report Location			210000

A.5.4.13 Activities (40).

TABLE A-XXXVIII. Activities entity/entity type/entity subtype.

Entity (Digits 1 and 2)	Entity Type (Digits 3 and 4)	Entity Subtype (Digits 5 and 6)	Code Note: The actual code is shown in bold numbers. The remaining numbers are used to show placement within the six digits.
Incident			110000
	Criminal Activity Incident		110100
		Arrest	110101
		Arson	110102
		Attempted Criminal Activity	110103
		Drive-by Shooting	110104
		Drug Related	110105
		Extortion	110106
		Graffiti	110107
		Killing	110108
		Poisoning	110109
		Civil Rioting	110110
		Booby Trap	110111

MIL-STD-2525D - APPENDIX A

TABLE A-XXXVIII. Activities entity/entity type/entity subtype - Continued.

Entity (Digits 1 and 2)	Entity Type (Digits 3 and 4)	Entity Subtype (Digits 5 and 6)	Code Note: The actual code is shown in bold numbers. The remaining numbers are used to show placement within the six digits.
		Home Eviction	110112
		Black Marketing	110113
		Vandalism/Loot/Ransack/Plunder	110114
		Jail Break	110115
		Robbery	110116
		Theft	110117
		Burglary	110118
		Smuggling	110119
		Rock Throwing	110120
		Dead Body	110121
		Sabotage	110122
		Suspicious Activity	110123
	Bomb/Bombing		110200
		Bomb Threat	110201
	IED Event		110300
		IED Explosion	110301
		Premature IED Explosion	110302
		IED Cache	110303
		IED Suicide Bomber	110304
	Shooting		110400
		Sniping	110401
	Illegal Drug Operation		110500
		Trafficking	110501
		Illegal Drug Lab	110502
	Explosion		110600
		Grenade Explosion	110601
		Incendiary Explosion	110602
		Mine Explosion	110603
		Mortar Fire Explosion	110604
		Rocket Explosion	110605
		Bomb Explosion	110606
Civil Disturbance			120000
	Demonstration		120100
Operation			130000
	Patrolling		130100
	Military Information Support Operation (MISO)		130200
		TV and Radio Propaganda	130201
	Foraging/Searching		130300
	Recruitment		130400

MIL-STD-2525D - APPENDIX A

TABLE A-XXXVIII. Activities entity/entity type/entity subtype - Continued.

Entity (Digits 1 and 2)	Entity Type (Digits 3 and 4)	Entity Subtype (Digits 5 and 6)	Code Note: The actual code is shown in bold numbers. The remaining numbers are used to show placement within the six digits.
		Willing	1304 01
		Coerced/Impressed	1304 02
	Mine Laying		130 500
	Spy		130 600
	Warrant Served		130 700
	Exfiltration		130 800
	Infiltration		130 900
	Meeting		13 1000
		Polling Place/Election	131 001
	Raid on House		131 100
	Emergency Operation		131 200
		Emergency Collection Evacuation Point	131 201
		Emergency Food Distribution	131 202
		Emergency Incident Command Center	131 203
		Emergency Operations Center	131 204
		Emergency Public Information Center	131 205
		Emergency Shelter	131 206
		Emergency Staging Area	131 207
		Emergency Water Distribution Center	131 208
	Emergency Medical Operation		131 300
		EMT Station Location	131 301
		Health Department Facility	131 302
		Medical Facilities Outpatient	131 303
		Morgue	131 304
		Pharmacy	131 305
		Triage	131 306
	Fire Fighting Operation		131 400
		Fire Hydrant	1314 01
		Fire Station	1314 02
		Other Water Supply Location	1314 03
	Law Enforcement Operation		131 500
		Bureau of Alcohol, Tobacco, Firearms and Explosives (ATF) (Department of Justice)	131 501
		Border Patrol	131 502
		Customs Service	131 503
		Drug Enforcement Administration (DEA)	131 504
		Department of Justice (DOJ)	131 505
		Federal Bureau of Investigation (FBI)	131 506

MIL-STD-2525D - APPENDIX A

TABLE A-XXXVIII. Activities entity/entity type/entity subtype - Continued.

Entity (Digits 1 and 2)	Entity Type (Digits 3 and 4)	Entity Subtype (Digits 5 and 6)	Code Note: The actual code is shown in bold numbers. The remaining numbers are used to show placement within the six digits.
		Police	131 507
		Prison	131 508
		United States Secret Service(Treas) (USSS)	131 509
		Transportation Security Administration (TSA)	131 510
		Coast Guard	131 511
		US Marshals Service	131 512
		Internal Security Force	131 513
Fire Event			140000
	Fire Origin		140100
	Smoke		140200
	Hot Spot		140300
	Non-Residential Fire		140400
	Residential Fire		140500
	School Fire		140600
	Special Needs Fire		140700
	Wild Fire		140800
Hazardous Materials			150000
	Hazardous Materials Incident		150100
		Chemical Agent	150101
		Corrosive Material	150102
		Hazardous when Wet	150103
		Explosive Material	150104
		Flammable Gas	150105
		Flammable Liquid	150106
		Flammable Solid	150107
		Non-Flammable Gas	150108
		Organic Peroxide	150109
		Oxidizer	150110
		Radioactive Material	150111
		Spontaneously Combustible Material	150112
		Toxic Gas	150113
		Toxic Infectious Material	150114
		Unexploded Ordnance	150115
Transportation Incident			160000
	Air-		160100
	Marine-		160200

MIL-STD-2525D - APPENDIX A

TABLE A-XXXVIII. Activities entity/entity type/entity subtype - Continued.

Entity (Digits 1 and 2)	Entity Type (Digits 3 and 4)	Entity Subtype (Digits 5 and 6)	Code Note: The actual code is shown in bold numbers. The remaining numbers are used to show placement within the six digits.
	Rail-		160300
	Vehicle-		160400
	Wheeled Vehicle Explosion		160500
Natural Event			170000
	Geologic		170100
		Aftershock	170101
		Avalanche	170102
		Earthquake Epicenter	170103
		Landslide	170104
		Subsidence	170105
		Volcanic Eruption	170106
		Volcanic Threat	170107
		Cave Entrance	170108
	Hydro-Meteorological		170200
		Drought	170201
		Flood	170202
		Tsunami	170203
	Infestation		170300
		Bird	170301
		Insect	170302
		Microbial	170303
		Reptile	170304
		Rodent	170305
Individual			180000
	Religious Leader		180100
	Speaker		180200

TABLE A-XXXIX. Activities sector 1 modifier.

First Modifier	MIL-STD-2525D Code	Remarks.
Unspecified	00	
Assassination	01	
Execution (Wrongful Killing)	02	
Hijacking/Hijacked	03	
House-to-House	04	
Kidnapping	05	
Murder	06	
Piracy	07	
Rape	08	
Written Military Information Support Operations	09	

MIL-STD-2525D - APPENDIX A

TABLE A-XXXIX. Activities sector 1 modifier - Continued.

First Modifier	MIL-STD-2525D Code	Remarks.
Pirate	10	
False	11	
Find	12	
Found and Cleared	13	
Hoax (Decoy)	14	
Attempted	15	
Accident	16	
Incident	17	
Theft	18	
Reserved for Future Use	19-98	Assigned by SSMC/JSP only
Version Extension Flag	99	

A.5.4.14 Atmospheric (45).

TABLE A-XL. Atmospheric entity/entity type/entity subtype.

Entity (Digits 1 and 2)	Entity Type (Digits 3 and 4)	Entity Subtype (Digits 5 and 6)	Code Note: The actual code is shown in bold numbers. The remaining numbers are used to show placement within the six digits.
Pressure Systems			110000
	Low Pressure Center		110100
		Cyclone Center	110101
		Tropopause Low	110102
	High Pressure Center		110200
		Anticyclone Center	110201
		Tropopause High	110202
	Frontal Systems		110300
		Cold Front	110301
		Upper Cold Front	110302
		Cold Frontogenesis	110303
		Cold Frontolysis	110304
		Warm Front	110305
		Upper Warm Front	110306
		Warm Frontogenesis	110307
		Warm Frontolysis	110308
		Occluded Front	110309
		Upper Occluded Front	110310
		Occluded Frontolysis	110311
		Stationary Front	110312
		Upper Stationary Front	110313
		Stationary Frontogenesis	110314
		Stationary Frontolysis	110315
	Lines		110400

MIL-STD-2525D - APPENDIX A

TABLE A-XL. Atmospheric entity/entity type/entity subtype - Continued.

Entity (Digits 1 and 2)	Entity Type (Digits 3 and 4)	Entity Subtype (Digits 5 and 6)	Code Note: The actual code is shown in bold numbers. The remaining numbers are used to show placement within the six digits.
		Trough Axis	1104 01
		Upper Trough Axis	1104 02
		Ridge Axis	1104 03
		Severe Squall Line	1104 04
		Instability Line	1104 05
		Shear Line	1104 06
		Inter-Tropical Convergence Zone	1104 07
		Convergence Line	1104 08
		Inter-Tropical Discontinuity	1104 09
	Pressure Tendency		110 500
		Rise Then Fall Higher	110 501
		Rise Then Steady	110 502
		Rise	110 503
		Rise Then Rise Higher	110 504
		Steady	110 505
		Fall Then Rise Lower	110 506
		Fall Then Steady	110 507
		Fall	110 508
		Rise Then Fall Lower	110 509
Turbulence			120000
	Light		120100
	Moderate		120200
	Severe		120300
	Extreme		120400
	Mountain Waves		120500
Icing			130000
	Clear Icing		130100
		Light	130101
		Moderate	130102
		Severe	130103
	Rime Icing		130200
		Light	130201
		Moderate	130202
		Severe	130203
	Mixed Icing		130300
		Light	130301
		Moderate	130302
		Severe	130303
Winds			140000
	Calm Winds		140100

MIL-STD-2525D - APPENDIX A

TABLE A-XL. Atmospheric entity/entity type/entity subtype - Continued.

Entity (Digits 1 and 2)	Entity Type (Digits 3 and 4)	Entity Subtype (Digits 5 and 6)	Code Note: The actual code is shown in bold numbers. The remaining numbers are used to show placement within the six digits.
	Wind Plot		140 2 00
	Jet Stream		140 3 00
	Stream Line		140 4 00
Cloud Cover			15 0000
	Cloud Coverage Symbols		15 0100
		Clear Sky	1501 01
		Few Coverage	1501 02
		Scattered Coverage	1501 03
		Broken Coverage	1501 04
		Overcast Coverage	1501 05
		Sky Totally or Partially Obscured	1501 06
Weather Symbols			16 0000
	Rain		16 0100
		Intermittent Light	1601 01
		Continuous Light	1601 02
		Intermittent Moderate	1601 03
		Intermittent Moderate/Continuous Moderate	1601 04
		Intermittent Heavy	1601 05
		Intermittent Heavy/Continuous Heavy	1601 06
	Freezing Rain		16 0200
		Light	1602 01
		Moderate/Heavy	1602 02
	Rain Showers		16 0300
		Light	1603 01
		Moderate/Heavy	1603 02
		Torrential	1603 03
	Drizzle		16 0400
		Intermittent Light	1604 01
		Intermittent Light/ Continuous Light	1604 02
		Intermittent Moderate	1604 03
		Intermittent Moderate /Continuous Moderate	1604 04
		Intermittent Heavy	1604 05
		Intermittent Heavy /Continuous Heavy	1604 06
	Freezing Drizzle		16 0500
		Light	1605 01
		Moderate/Heavy	1605 02
	Rain and Snow Mixed		16 0600
		Rain or Drizzle and Snow – Light	1606 01

MIL-STD-2525D - APPENDIX A

TABLE A-XL. Atmospheric entity/entity type/entity subtype - Continued.

Entity (Digits 1 and 2)	Entity Type (Digits 3 and 4)	Entity Subtype (Digits 5 and 6)	Code <small>Note: The actual code is shown in bold numbers. The remaining numbers are used to show placement within the six digits.</small>
		Rain or Drizzle and Snow – Moderate/Heavy	1606 02
		Rain and Snow Showers – Light	1606 03
		Rain and Snow Showers – Moderate/Heavy	1606 04
	Snow		1607 00
		Intermittent Light	1607 01
		Intermittent Light/Continuous Light	1607 02
		Intermittent Moderate	1607 03
		Intermittent Moderate /Continuous Moderate	1607 04
		Intermittent Heavy	1607 05
		Intermittent Heavy /Continuous Heavy	1607 06
		Blowing Snow – Light/Moderate	1607 07
		Blowing Snow – Heavy	1607 08
	Snow Grains		1608 00
	Snow Showers		1609 00
		Light	1609 01
		Moderate/Heavy	1609 02
	Hail		1610 00
		Light not Associated with Thunder	1610 01
		Moderate/Heavy not Associated with Thunder	1610 02
	Ice Crystals (Diamond Dust)		1611 00
	Ice Pellets (Sleet)		1612 00
		Light	1612 01
		Moderate	1612 02
		Heavy	1612 03
	Inversion		1613 00
	Storms		1614 00
		Thunderstorm – No Precipitation	1614 01
		Thunderstorm Light to Moderate with Rain/Snow – No Hail	1614 02
		Thunderstorm Heavy with Rain/Snow – No Hail	1614 03
		Thunderstorm Light to Moderate – With Hail	1614 04
		Thunderstorm Heavy – With Hail	1614 05
		Funnel Cloud (Tornado/Waterspout)	1614 06
		Squall	1614 07
		Lightning	1614 08

MIL-STD-2525D - APPENDIX A

TABLE A-XL. Atmospheric entity/entity type/entity subtype - Continued.

Entity (Digits 1 and 2)	Entity Type (Digits 3 and 4)	Entity Subtype (Digits 5 and 6)	Code <small>Note: The actual code is shown in bold numbers. The remaining numbers are used to show placement within the six digits.</small>
	Fog		161500
		Shallow Patches	161501
		Shallow Continuous	161502
		Patchy	161503
		Sky Visible	161504
		Sky Obscured	161505
		Freezing, Sky Visible	161506
		Freezing, Sky Obscured	161507
	Mist		161600
	Smoke		161700
	Haze		161800
	Dust or Sand		161900
		Light to Moderate	161901
		Severe	161902
		Dust Devil	161903
		Blowing Dust or Sand	161904
	Tropical Storm Systems		162000
		Tropical Depression	162001
		Tropical Storm	162002
		Hurricane/Typhoon	162003
		Tropical Storm Wind Areas and Date/Time Labels	162004
	Volcanic Eruption		162100
		Volcanic Ash	162101
	Tropopause Level		162200
	Freezing Level		162300
	Precipitation of Unknown Type and Intensity		162400
Bounded Areas of Weather			170000
	Instrument Flight Rule (IFR)		170100
	Marginal Visual Flight Rule (MVFR)		170200
	Turbulence		170300
	Icing		170400
	Liquid Precipitation – Non-Convective Continuous or Intermittent		170500
		Liquid Precipitation – Convective	170501
	Freezing /Frozen Precipitation		170600
	Thunderstorm		170700

TABLE A-XL. Atmospheric entity/entity type/entity subtype - Continued.

Entity (Digits 1 and 2)	Entity Type (Digits 3 and 4)	Entity Subtype (Digits 5 and 6)	Code Note: The actual code is shown in bold numbers. The remaining numbers are used to show placement within the six digits.
	Fog		17 08 00
	Dust or Sand		17 09 00
	Operator-Defined Freeform		17 10 00
Isopleths			18 0000
	Isobar – Surface		1801 00
	Contour – Upper Air		1802 00
	Isotherm		1803 00
	Isotach		1804 00
	Isodrosotherm		1805 00
	Thickness		1806 00
	Operator-Defined Freeform		1807 00
State of the Ground			19 0000
	Without Snow or Measurable Ice Cover		19 01 00
		Surface Dry Without Cracks or Appreciable Dust or Loose Sand	1901 01
		Surface Moist	1901 02
		Surface Wet, Standing Water in Small or Large Pools	1901 03
		Surface Flooded	1901 04
		Surface Frozen	1901 05
		Glaze (Thin Ice) on Ground	1901 06
		Loose Dry Dust or Sand not Covering Ground Completely	1901 07
		Thin Loose Dry Dust or Sand Covering Ground Completely	1901 08
		Moderate/Thick Loose Dry Dust or Sand Covering Ground Completely	1901 09
		Extremely Dry with Cracks	1901 10
	With Snow or Measurable Ice Cover		19 02 00
		Predominately Ice Covered	1902 01
		Compact or Wet Snow (with or without Ice) Covering Less Than One-Half of Ground	1902 02
		Compact or Wet Snow (with or without Ice) Covering at Least One-Half of Ground, but Ground not Completely Covered	1902 03
		Even Layer of Compact or Wet Snow Covering Ground Completely	1902 04

TABLE A-XL. Atmospheric entity/entity type/entity subtype - Continued.

Entity (Digits 1 and 2)	Entity Type (Digits 3 and 4)	Entity Subtype (Digits 5 and 6)	Code Note: The actual code is shown in bold numbers. The remaining numbers are used to show placement within the six digits.
		Uneven Layer of Compact or Wet Snow Covering Ground Completely	1902 05
		Loose Dry Snow Covering Less Than One-Half of Ground	1902 06
		Loose Dry Snow Covering at Least One-Half of Ground, but Ground not Completely Covered	1902 07
		Even Layer of Loose Dry Snow Covering Ground Completely	1902 08
		Uneven Layer of Loose Dry Snow Covering Ground Completely	1902 09
		Snow Covering Ground Completely, Deep Drifts	1902 10

A.5.4.15 Oceanographic (46).TABLE A-XLI. Oceanographic entity/entity type/entity subtype.

Entity (Digits 1 and 2)	Entity Type (Digits 3 and 4)	Entity Subtype (Digits 5 and 6)	Code Note: The actual code is shown in bold numbers. The remaining numbers are used to show placement within the six digits.
Ice Systems			110000
	Icebergs		110100
		Many Icebergs	110101
		Belts and Strips	110102
		General	110103
		Many Icebergs – General	110104
		Bergy Bit	110105
		Many Bergy Bits	110106
		Growler	110107
		Many Growlers	110108
		Floeberg	110109
		Ice Island	110110
	Ice Concentration		110200
		Bergy Water	110201
		Water with Radar Targets	110202
		Ice Free	110203
	Dynamic Processes		110300

TABLE A-XLI. Oceanographic entity/entity type/entity subtype - Continued.

Entity (Digits 1 and 2)	Entity Type (Digits 3 and 4)	Entity Subtype (Digits 5 and 6)	Code Note: The actual code is shown in bold numbers. The remaining numbers are used to show placement within the six digits.
		Convergence	1103 01
		Divergence	1103 02
		Shearing or Shear Zone	1103 03
		Ice Drift (Direction)	1103 04
	Sea Ice		11 04 00
		Ice Thickness (Observed)	1104 01
		Ice Thickness (Estimated)	1104 02
		Melt Puddles or Flooded Ice	1104 03
	Limits		11 05 00
		Limits of Visual Observation	1105 01
		Limits of Under Cast	1105 02
		Limits of Radar Observation	1105 03
		Observed Ice Edge or Boundary	1105 04
		Estimated Ice Edge or Boundary	1105 05
		Ice Edge or Boundary From Radar	1105 06
	Openings in the Ice		11 06 00
		Cracks	1106 01
		Cracks at a Specific Location	1106 02
		Lead	1106 03
		Frozen Lead	1106 04
	Snow Cover		11 07 00
		Sastrugi (with Orientation)	1107 01
	Topographical Features		11 08 00
		Ridges or Hummocks	1108 01
		Rafting	1108 02
		Jammed Brush Barrier	1108 03
Hydrography			12 0000
	Depth		12 0100
		Soundings	1201 01
		Depth Curve	1201 02
		Depth Contour	1201 03
		Depth Area	1201 04
	Coastal Hydrography		12 0200
		Coastline	1202 01
		Island	1202 02
		Beach	1202 03
		Water	1202 04
		Foreshore – Line	1202 05
		Foreshore – Area	1202 06
	Ports and Harbors		12 0300

MIL-STD-2525D - APPENDIX A

TABLE A-XLI. Oceanographic entity/entity type/entity subtype - Continued.

Entity (Digits 1 and 2)	Entity Type (Digits 3 and 4)	Entity Subtype (Digits 5 and 6)	Code <small>Note: The actual code is shown in bold numbers. The remaining numbers are used to show placement within the six digits.</small>
		Ports	1203 01
		Berths (Onshore)	1203 02
		Berths (Anchor)	1203 03
		Anchorage – Point	1203 04
		Anchorage – Line	1203 05
		Anchorage – Area	1203 06
		Call in Point	1203 07
		Pier/Wharf/Quay	1203 08
		Fishing Harbor – Point	1203 09
		Fish Weirs – Point	1203 10
		Fish Stakes – Point	1203 11
		Fish Traps – Area	1203 12
		Facilities	1203 13
		Drydock	1203 14
		Landing Place	1203 15
		Offshore Loading Facility – Point	1203 16
		Offshore Loading Facility – Line	1203 17
		Offshore Loading Facility – Area	1203 18
		Ramp – Above Water	1203 19
		Ramp – Below Water	1203 20
		Landing Ring	1203 21
		Ferry Crossing	1203 22
		Cable Ferry Crossing	1203 23
		Dolphin	1203 24
		Shoreline Protection	1203 25
		Breakwater/Groin/Jetty – Above Water	1203 26
		Breakwater/Groin/Jetty – Below Water	1203 27
		Seawall	1203 28
	Aids to Navigation		12 04 00
		Beacon	1204 01
		Buoy Default	1204 02
		Marker	1204 03
		Perches/Stakes – Point	1204 04
		Perches/Stakes – Area	1204 05
		Light	1204 06
		Leading Line	1204 07
		Light Vessel/Light Ship	1204 08
		Lighthouse	1204 09
	Dangers/Hazards		12 05 00
		Rock Submerged	1205 01

MIL-STD-2525D - APPENDIX A

TABLE A-XLI. Oceanographic entity/entity type/entity subtype - Continued.

Entity (Digits 1 and 2)	Entity Type (Digits 3 and 4)	Entity Subtype (Digits 5 and 6)	Code Note: The actual code is shown in bold numbers. The remaining numbers are used to show placement within the six digits.
		Rock Awashed	1205 02
		Underwater Danger/Hazard	1205 03
		Foul Ground – Point	1205 04
		Foul Ground – Area	1205 05
		Kelp/Seaweed – Point	1205 06
		Kelp/Seaweed – Area	1205 07
		Snags/Stumps	1205 08
		Wreck (Uncovers)	1205 09
		Wreck (Submerged)	1205 10
		Breakers	1205 11
		Reef	1205 12
		Eddies/Overfalls/Tide Rips	1205 13
		Discolored Water	1205 14
	Bottom Features		120 600
		Bottom Characteristics - Sand	120 601
		Bottom Characteristics - Mud	120 602
		Bottom Characteristics - Clay	120 603
		Bottom Characteristics - Silt	120 604
		Bottom Characteristics - Stones	120 605
		Bottom Characteristics - Gravel	120 606
		Bottom Characteristics - Pebbles	120 607
		Bottom Characteristics - Cobbles	120 608
		Bottom Characteristics - Rock	120 609
		Bottom Characteristics - Coral	120 610
		Bottom Characteristics - Shell	120 611
		Qualifying Terms - Fine	120 612
		Qualifying Terms - Medium	120 613
		Qualifying Terms - Coarse	120 614
	Tide and Current		120 700
		Water Turbulence	120 701
		Current Flow – Ebb	120 702
		Current Flow – Flood	120 703
		Tide Data Point	120 704
		Tide Gauge	120 705
Oceanography			130000
	Bioluminescence		130100
		Visual Detection Ratio (VDR) Level 1–2	130101
		VDR Level 2–3	130102
		VDR Level 3–4	130103

MIL-STD-2525D - APPENDIX A

TABLE A-XLI. Oceanographic entity/entity type/entity subtype - Continued.

Entity (Digits 1 and 2)	Entity Type (Digits 3 and 4)	Entity Subtype (Digits 5 and 6)	Code <small>Note: The actual code is shown in bold numbers. The remaining numbers are used to show placement within the six digits.</small>
		VDR Level 4–5	1301 04
		VDR Level 5–6	1301 05
		VDR Level 6–7	1301 06
		VDR Level 7–8	1301 07
		VDR Level 8–9	1301 08
		VDR Level 9–10	1301 09
	Beach Slope		130 200
		Flat	1302 01
		Gentle	1302 02
		Moderate	1302 03
		Steep	1302 04
Geophysics/Acoustics			140000
	Mine Warfare (MIW) Bottom Descriptors		140 100
		MIW Bottom Sediments - Solid Rock	1401 01
		MIW Bottom Sediments - Clay	1401 02
		MIW Bottom Sediments - Very Coarse Sand	1401 03
		MIW Bottom Sediments - Coarse Sand	1401 04
		MIW Bottom Sediments - Medium Sand	1401 05
		MIW Bottom Sediments - Fine Sand	1401 06
		MIW Bottom Sediments - Very Fine Sand	1401 07
		MIW Bottom Sediments - Very Fine Silt	1401 08
		MIW Bottom Sediments - Fine Silt	1401 09
		MIW Bottom Sediments - Medium Silt	1401 10
		MIW Bottom Sediments - Coarse Silt	1401 11
		MIW Bottom Sediments - Boulders	1401 12
		MIW Bottom Sediments - Cobbles, Oyster Shells	1401 13
		MIW Bottom Sediments - Pebbles, Shells	1401 14
		MIW Bottom Sediments - Sand and Shells	1401 15
		MIW Bottom Sediment - Land	1401 16
		MIW Bottom Sediment - No Data	1401 17
		Bottom Roughness - Smooth	1401 18
		Bottom Roughness - Moderate	1401 19
		Bottom Roughness - Rough	1401 20

TABLE A-XLI. Oceanographic entity/entity type/entity subtype - Continued.

Entity (Digits 1 and 2)	Entity Type (Digits 3 and 4)	Entity Subtype (Digits 5 and 6)	Code Note: The actual code is shown in bold numbers. The remaining numbers are used to show placement within the six digits.
		Clutter (Bottom) - Low	1401 21
		Clutter (Bottom) - Medium	1401 22
		Clutter (Bottom) - High	1401 23
		Impact Burial - 0%	1401 24
		Impact Burial - 0–10%	1401 25
		Impact Burial - 10–20%	1401 26
		Impact Burial - 20–75%	1401 27
		Impact Burial - >75%	1401 28
		MIW Bottom Category A	1401 29
		MIW Bottom Category B	1401 30
		MIW Bottom Category C	1401 31
		MIW Bottom Type A1	1401 32
		MIW Bottom Type A2	1401 33
		MIW Bottom Type A3	1401 34
		MIW Bottom Type B1	1401 35
		MIW Bottom Type B2	1401 36
		MIW Bottom Type B3	1401 37
		MIW Bottom Type C1	1401 38
		MIW Bottom Type C2	1401 39
		MIW Bottom Type C3	1401 40
Limits			150000
	Maritime Limit Boundary		150100
	Maritime Area		150200
	Restricted Area		150300
	Swept Area		150400
	Training Area		150500
	Operator-Defined		150600
Man-Made Structures			160000
	Submarine Cable		160100
	Submerged Crib		160200
	Canal		160300
	Ford		160400
	Lock		160500
	Oil/Gas Rig		160600
	Oil/Gas Rig Field		160700
	Pipelines/Pipe		160800
	Pile/Piling/Post		160900

A.5.4.16 Meteorological space (47).TABLE A-XLII. Meteorological space equipment entity/entity type/entity subtype.

Entity (Digits 1 and 2)	Entity Type (Digits 3 and 4)	Entity Subtype (Digits 5 and 6)	Code Note: The actual code is shown in bold numbers. The remaining numbers are used to show placement within the six digits.
Space			110000

A.5.4.17 Signals intelligence equipment (50, 51, 52, 53, 54).TABLE A-XLIII. Signals intelligence equipment entity/entity type/entity subtype.

Entity (Digits 1 and 2)	Entity Type (Digits 3 and 4)	Entity Subtype (Digits 5 and 6)	Code Note: The actual code is shown in bold numbers. The remaining numbers are used to show placement within the six digits.
Signal Intercept			110000
	Communications		110100
	Jammer		110200
	Radar		110300

TABLE A-XLIV. Signals intelligence equipment sector 1 modifier.

First Modifier	MIL-STD-2525D Code	Remarks.
Unspecified	00	
Anti-Aircraft Fire Control	01	
Airborne Search and Bombing	02	
Airborne Intercept	03	
Altimeter	04	
Airborne Reconnaissance and Mapping	05	
Air Traffic Control	06	
Beacon Transponder (not IFF)	07	
Battlefield Surveillance	08	
Controlled Approach	09	
Controlled Intercept	10	
Cellular/Mobile	11	
Coastal Surveillance	12	
Decoy/Mimic	13	
Data Transmission	14	
Earth Surveillance	15	
Early Warning	16	
Fire Control	17	
Ground Mapping	18	
Height Finding	19	
Harbor Surveillance	20	

MIL-STD-2525D - APPENDIX A

TABLE A-XLIV. Signals intelligence equipment sector 1 modifier - Continued.

First Modifier	MIL-STD-2525D Code	Remarks.
Identification, Friend or Foe (Interrogator)	21	
Instrument Landing System	22	
Ionospheric Sounding	23	
Identification, Friend or Foe (Transponder)	24	
Barrage Jammer	25	
Click Jammer	26	
Deceptive Jammer	27	
Frequency Swept Jammer	28	
Jammer (general)	29	
Noise Jammer	30	
Pulsed Jammer	31	
Repeater Jammer	32	
Spot Noise Jammer	33	
Transponder Jammer	34	
Missile Acquisition	35	
Missile Control	36	
Missile Downlink	37	
Meteorological	38	
Multi-Function	39	
Missile Guidance	40	
Missile Homing	41	
Missile Tracking	42	
Navigational/General	43	
Navigational/Distance Measuring Equipment	44	
Navigation/Terrain Following	45	
Navigational/Weather Avoidance	46	
Omni-Line of Sight (LOS)	47	
Proximity Use	48	
Point-to-Point Line of Sight (LOS)	49	
Instrumentation	50	
Range Only	51	
Sonobuoy	52	
Satellite Downlink	53	
Space	54	
Surface Search	55	
Shell Tracking	56	
Satellite Uplink	57	
Target Acquisition	58	
Target Illumination	59	
Tropospheric Scatter	60	
Target Tracking	61	
Unknown	62	
Video Remoting	63	
Experimental	64	
Reserved for Future Use	65-98	Assigned by SSMC/JSP only
Version Extension Flag	99	

A.5.4.18 Cyberspace (60).TABLE A-XLV. Cyberspace entity/entity type/entity subtype.

Entity (Digits 1 and 2)	Entity Type (Digits 3 and 4)	Entity Subtype (Digits 5 and 6)	Code <small>Note: The actual code is shown in bold numbers. The remaining numbers are used to show placement within the six digits.</small>
Botnet			110000
	Command and Control (C2)		110100
	Herder		110200
	Callback Domain		110300
	Zombie		110400
Infection			120000
	Advanced Persistent Threat (APT)		120100
		APT with C2	120101
		APT with Self Propagation	120102
		APT with C2 and Self Propagation	120103
		APT Other	120104
	Non-Advanced Persistent Threat (NAPT)		120200
		NAPT with C2	120201
		NAPT with Self Propagation	120202
		NAPT with C2 and Self Propagation	120203
		NAPT Other	120204
Health and Status			130000
	Normal		130100
	Network Outage		130200
	Unknown		130300
	Impaired		130400
Device Type			140000
	Core Router		140100
	Router		140200
	Cross Domain Solution		140300
	Mail Server		140400
	Web Server		140500
	Domain Server		140600
	File Server		140700
	Peer-to-Peer Node		140800
	Firewall		140900
	Switch		141000
	Host		141100
	Virtual Private Network (VPN)		141200
Device Domain			150000
	Department of Defense (DoD)		150100

TABLE A-XLV. Cyberspace entity/entity type/entity subtype - Continued.

Entity (Digits 1 and 2)	Entity Type (Digits 3 and 4)	Entity Subtype (Digits 5 and 6)	Code Note: The actual code is shown in bold numbers. The remaining numbers are used to show placement within the six digits.
	Government		150200
	Contractor		150300
	Supervisory Control and Data Acquisition (SCADA)		150400
	Non-Government		150500
Effect			160000
	Infection		160100
	Degradation		160200
	Data Spoofing		160300
	Data Manipulation		160400
	Exfiltration		160500
	Power Outage		160600
	Network Outage		160700
	Service Outage		160800
	Device Outage		160900

A.5.5 Third Ten Digits. The conditional set C of the SIDC is to accommodate national modifications/additions that are not included in MIL-STD-2525. In particular, when a nation (or approved entity) has a need to transfer symbol information to another allied country/system, then set C provides an approved method to achieve this capability. Set C starts with a three digit number pre-assigned to nations (refer to APP-6 Annex A) which indicates to a recipient the source of the complete 30-digit SIDCs. The fourth digit (if required) is to be used by nations to identify a particular symbol set. The remaining six digits are available for whatever use the source nation decides. To correctly interpret a complete 30-digit SIDC requires the source nation using Set C to provide amplifying documentation to recipients. **Set C should not be used to reinterpret an approved MIL-STD-2525 symbol.**

APPENDIX B - SPACE SYMBOLS

B.1 SCOPE

B.1.1 Scope. This appendix addresses symbols that support space equipment and weapons in the C2 domain. The tables in this appendix present the icons and modifiers for the space domain. This appendix is divided into two sections ([see figure B-1](#)): 1) equipment and platform symbols ([see section B.6](#)) and 2) missile symbols ([see section B.7](#)). This appendix is a mandatory part of the standard. The information contained herein is intended for compliance.

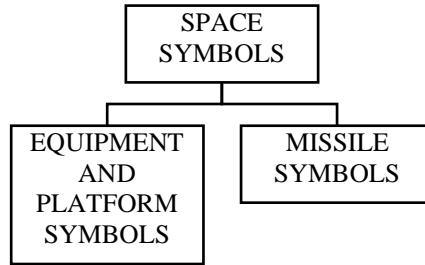

FIGURE B-1. Space appendix sections.

B.2 APPLICABLE DOCUMENTS

Specific documents in [2.2](#) of this standard apply to this appendix.

B.3 DEFINITIONS

The definitions in [section 3](#) of this standard apply to this appendix.

B.4 GENERAL REQUIREMENTS

B.4.1 Organization. This appendix contains technical specifications, a symbol coding scheme, a symbology hierarchy and space symbology.

B.5 DETAILED REQUIREMENTS

B.5.1 Technical specifications. Composition, construction and display of symbols are explained in the detailed requirements section of the standard.

B.5.2 Symbol identification coding scheme. A symbol identification code (SIDC) is a numeric string that may be used to provide the unique identifier necessary to display or exchange symbol information between MIL-STD-2525 compliant systems. Refer to [Appendix A](#) for SIDC positions and descriptions.

B.5.3 Composition of space symbols. A standard method for constructing symbols is presented. Refer to [5.3.8](#) for an explanation of symbol composition. [Figure B-2](#) shows an example of a space equipment symbol.

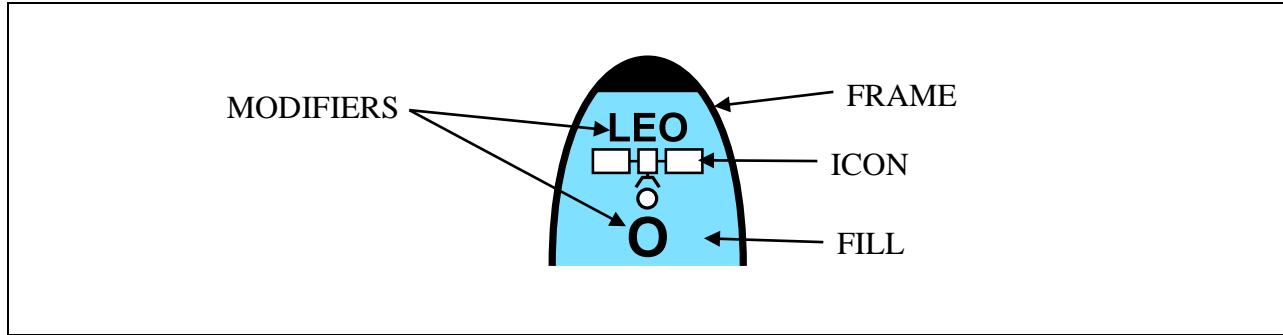

FIGURE B-2. Space symbol components.

B.5.3.1 Symbol building process. [Table B-I](#) depicts the symbol building process for space symbols. The process is identical for icons and modifiers requiring the vertical bounding octagon.

TABLE B-I. Space symbol building process.

STEP	DESCRIPTION	EXAMPLE
1.	<p>Choose the frame that matches the standard identity of the object from the space column in tables I, II, or III. In this example, the standard identity is friend.</p> <p>The example depicts a “friendly space track.”</p>	
2.	<p>Choose an icon for the main sector of the bounding octagon. In this example, the icon is “civilian earth observation satellite,” a space entity subtype.</p> <p>The example depicts a “friendly civilian earth observation satellite.”</p>	
3.	<p>If required, choose a modifier to depict an additional characteristic of the icon. In this example, the modifier is “low earth orbit,” a sector 1 modifier.</p> <p>The example depicts a “friendly civilian earth observation satellite on a low earth orbit.”</p>	

TABLE B-I. Space symbol building process - Continued.

STEP	DESCRIPTION	EXAMPLE
4.	<p>If required, choose a modifier to depict another characteristic of the icon. In this example, the modifier is “optical,” a sector 2 modifier.</p> <p>The example depicts a “friendly civilian earth observation satellite on a low earth orbit with optical sensor.”</p>	
5.	<p>The finished symbol will appear as shown in the example.</p>	

B.5.3.2 Icons and modifiers. All icons shall be placed within the main sector of the bounding octagon ([see table B-I](#)). When depicted, modifiers shall be placed in sectors 1 or 2 as appropriate ([see table B-I](#)). Only one modifier may be placed in each sector at a given time. Multiple modifiers in the same position are prohibited due to legibility concerns.

B.5.3.3 Amplifiers.

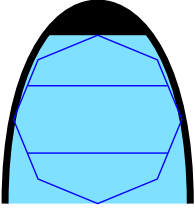
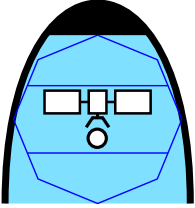
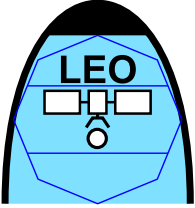
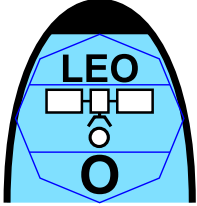
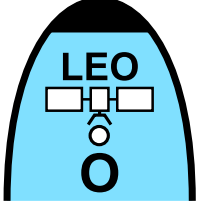
B.5.3.3.1 Text amplifiers. The purpose of the static text amplifiers described in this appendix is to standardize the display of additional alphanumeric information on identity, movement and location and capabilities. [See 5.1.6](#) for more information on amplifiers. [Figure B-3](#) shows the placement of space symbol amplifiers around the friend symbol frame. [Table B-II](#) provides descriptions and formats of each amplifier.

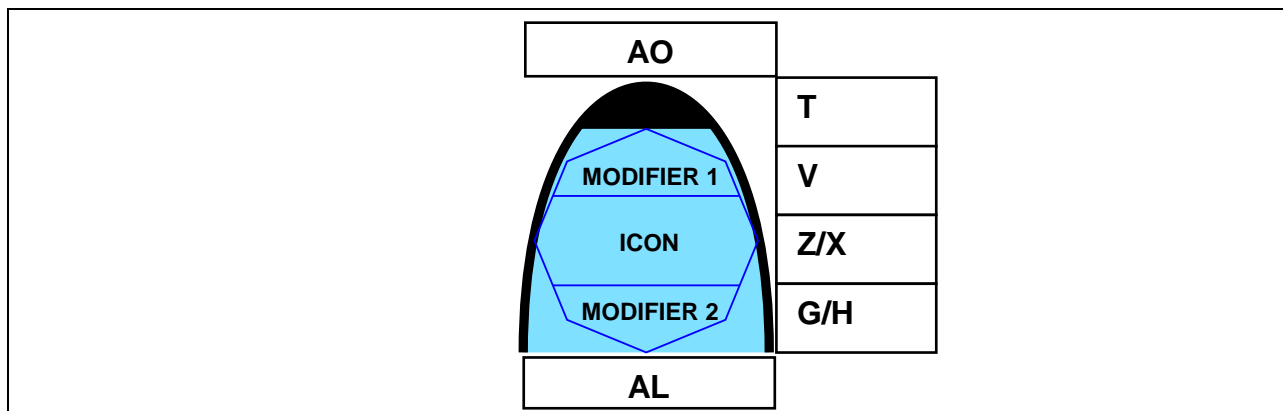

FIGURE B-3. Placement of space symbol amplifiers.

TABLE B-II. Descriptions and formats of space symbol amplifiers.

FIELD	FIELD TITLE	DESCRIPTION	FORMAT
A	Space Vehicle Icon	Uses icon and sector modifiers	
G	Staff Comments	A text amplifier for units, equipment and installations; content is implementation specific.	
H	Additional Information	A text amplifier for units, equipment and installations; content is implementation specific.	
T	Unique Designation (Track Number)	A text amplifier for units, equipment and installations that uniquely identifies a particular symbol or track number.	Prefix = TN:##### Example: TN:13579
V	Type	A text amplifier for equipment that indicates types of equipment.	
X	Altitude	A text amplifier for units that displays altitude flight level. See 5.3.6.5 for content.	Measurement units shall be displayed within the string Examples: 1500MSL FL150
Z	Speed	A text amplifier for units and equipment that displays velocity as set forth in MIL-STD-6040 .	
AL	Operational Condition	A graphic amplifier for equipment or installations that indicates operational condition or capacity.	Operational Condition amplifier, if used, shall be comprised of only one color. Ex. Satellite: Red - damaged, Green – fully capable Ex: Missile: Red – imminent threat, Green – no threat
AO	Engagement Bar	A graphic amplifier placed immediately atop the symbol. May denote, 1) local/remote status; 2) engagement status; and 3) weapon type.	A:BBB-CC, where A = remote/local BBB = engagement status CC = weapon asset

B.5.3.3.2 Graphic amplifiers. Graphic amplifiers can be static, located in a fixed position in relation to a track's symbol, or dynamic and move about the symbol based on the track's characteristics. [See 5.1.6](#) for more information on amplifiers, including examples of dynamic amplifiers.

B.6 SPACE EQUIPMENT AND PLATFORM SYMBOLS

B.6.1 Space equipment and platform symbols. This section includes the lists of icons and modifiers for building space equipment and platform symbols.

B.6.2 Space equipment and platform icons. [Table B-III](#) depicts space equipment and platform icons. Military symbols are depicted with black-filled icons, whereas civilian symbols are depicted with white-filled icons.

TABLE B-III. Space equipment and platform icons.





DESCRIPTION	ICON	REMARKS
MILITARY Type: Entity Symbol Set Code: 05 Code: 110000 Icon Type: Main		This symbol shall not be displayed on a C2 system, but may be displayed for training or hierarchal explanation purposes.
SPACE VEHICLE Type: Entity Type Entity: MILITARY Symbol Set Code: 05 Code: 110100 Icon Type: Main		N/A
RE-ENTRY VEHICLE Type: Entity Type Entity: MILITARY Symbol Set Code: 05 Code: 110200 Icon Type: Main		N/A
PLANET LANDER Type: Entity Type Entity: MILITARY Symbol Set Code: 05 Code: 110300 Icon Type: Main		N/A
ORBITER SHUTTLE Type: Entity Type Entity: MILITARY Symbol Set Code: 05 Code: 110400 Icon Type: Main		N/A
CAPSULE Type: Entity Type Entity: MILITARY Symbol Set Code: 05 Code: 110500 Icon Type: Main		N/A

TABLE B-III. Space equipment and platform icons - Continued.



DESCRIPTION	ICON	REMARKS
<p>SATELLITE, GENERAL</p> <p>Type: Entity Type Entity: MILITARY Symbol Set Code: 05 Code: 110600 Icon Type: Main</p>		<p>APP-6</p>
<p>SATELLITE</p> <p>Type: Entity Type Entity: MILITARY Symbol Set Code: 05 Code: 110700 Icon Type: Main</p>		<p>N/A</p>
<p>ANTISATELLITE WEAPON</p> <p>Type: Entity Type Entity: MILITARY Symbol Set Code: 05 Code: 110800 Icon Type: Main</p>		<p>N/A</p>
<p>ASTRONOMICAL SATELLITE</p> <p>Type: Entity Type Entity: MILITARY Symbol Set Code: 05 Code: 110900 Icon Type: Main</p>		<p>N/A</p>
<p>BIOSATELLITE</p> <p>Type: Entity Type Entity: MILITARY Symbol Set Code: 05 Code: 111000 Icon Type: Main</p>		<p>N/A</p>
<p>COMMUNICATIONS SATELLITE</p> <p>Type: Entity Type Entity: MILITARY Symbol Set Code: 05 Code: 111100 Icon Type: Main</p>		<p>N/A</p>
<p>EARTH OBSERVATION SATELLITE</p> <p>Type: Entity Type Entity: MILITARY Symbol Set Code: 05 Code: 111200 Icon Type: Main</p>		<p>N/A</p>

TABLE B-III. Space equipment and platform icons - Continued.

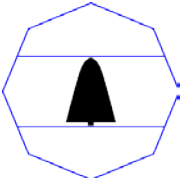
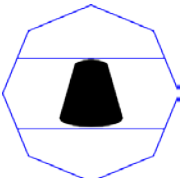

DESCRIPTION	ICON	REMARKS
MINIATURIZED SATELLITE Type: Entity Type Entity: MILITARY Symbol Set Code: 05 Code: 111300 Icon Type: Main		N/A
NAVIGATIONAL SATELLITE Type: Entity Type Entity: MILITARY Symbol Set Code: 05 Code: 111400 Icon Type: Main		N/A
RECONNAISSANCE SATELLITE Type: Entity Type Entity: MILITARY Symbol Set Code: 05 Code: 111500 Icon Type: Main		N/A
SPACE STATION Type: Entity Type Entity: MILITARY Symbol Set Code: 05 Code: 111600 Icon Type: Main		N/A
TETHERED SATELLITE Type: Entity Type Entity: MILITARY Symbol Set Code: 05 Code: 111700 Icon Type: Main		N/A
WEATHER SATELLITE Type: Entity Type Entity: MILITARY Symbol Set Code: 05 Code: 111800 Icon Type: Main		N/A
SPACE LAUNCHED VEHICLE (SLV) Type: Entity Type Entity: MILITARY Symbol Set Code: 05 Code: 111900 Icon Type: Main		N/A

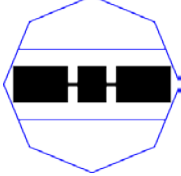
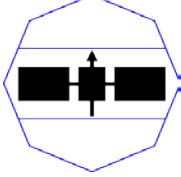
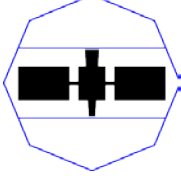
TABLE B-III. Space equipment and platform icons - Continued.

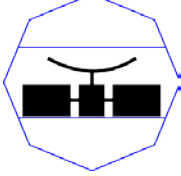
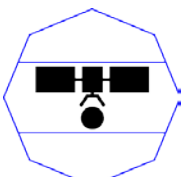

DESCRIPTION	ICON	REMARKS
<p>CIVILIAN</p> <p>Type: Entity Symbol Set Code: 05 Code: 120000 Icon Type: Main</p>		<p>This symbol shall not be displayed on a C2 system, but may be displayed for training or hierarchal explanation purposes.</p>
<p>ORBITER SHUTTLE</p> <p>Type: Entity Type Entity: CIVILIAN Symbol Set Code: 05 Code: 120100 Icon Type: Main</p>		<p>N/A</p>
<p>CAPSULE</p> <p>Type: Entity Type Entity: CIVILIAN Symbol Set Code: 05 Code: 120200 Icon Type: Main</p>		<p>N/A</p>
<p>SATELLITE</p> <p>Type: Entity Type Entity: CIVILIAN Symbol Set Code: 05 Code: 120300 Icon Type: Main</p>		<p>N/A</p>
<p>ASTRONOMICAL SATELLITE</p> <p>Type: Entity Type Entity: CIVILIAN Symbol Set Code: 05 Code: 120400 Icon Type: Main</p>		<p>N/A</p>
<p>BIOSATELLITE</p> <p>Type: Entity Type Entity: CIVILIAN Symbol Set Code: 05 Code: 120500</p>		<p>N/A</p>
<p>COMMUNICATIONS SATELLITE</p> <p>Type: Entity Type Entity: CIVILIAN Symbol Set Code: 05 Code: 120600 Icon Type: Main</p>		<p>N/A</p>

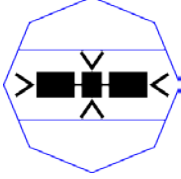
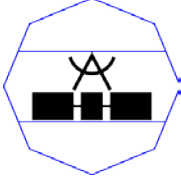
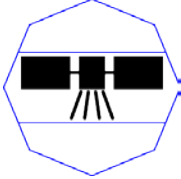
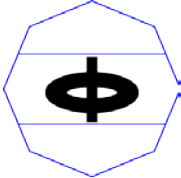
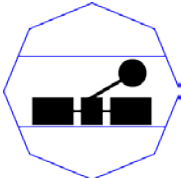
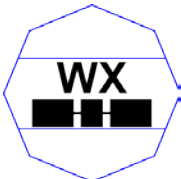
TABLE B-III. Space equipment and platform icons - Continued.

DESCRIPTION	ICON	REMARKS
<p>EARTH OBSERVATION SATELLITE</p> <p>Type: Entity Type Entity: CIVILIAN Symbol Set Code: 05 Code: 120700 Icon Type: Main</p>		<p>N/A</p>
<p>MINIATURIZED SATELLITE</p> <p>Type: Entity Type Entity: CIVILIAN Symbol Set Code: 05 Code: 120800 Icon Type: Main</p>		<p>N/A</p>
<p>NAVIGATIONAL SATELLITE</p> <p>Type: Entity Type Entity: CIVILIAN Symbol Set Code: 05 Code: 120900 Icon Type: Main</p>		<p>N/A</p>
<p>SPACE STATION</p> <p>Type: Entity Type Entity: CIVILIAN Symbol Set Code: 05 Code: 121000 Icon Type: Main</p>		<p>N/A</p>
<p>TETHERED SATELLITE</p> <p>Type: Entity Type Entity: CIVILIAN Symbol Set Code: 05 Code: 121100 Icon Type: Main</p>		<p>N/A</p>
<p>WEATHER SATELLITE</p> <p>Type: Entity Type Entity: CIVILIAN Symbol Set Code: 05 Code: 121200 Icon Type: Main</p>		<p>N/A</p>
<p>MANUAL TRACK</p> <p>Type: Entity (Local) Symbol Set Code: 05 Code: 130000 Icon Type: Full Octagon</p>		<p>N/A</p>

B.6.3 Space equipment and platform sector 1 modifiers. Space equipment and platform sector 1 modifiers denote orbit category. [Table B-IV](#) lists space equipment and platform sector 1 modifiers and illustrates their placement within the bounding octagon.

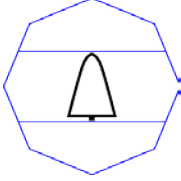
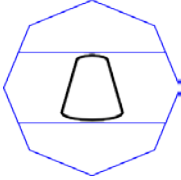
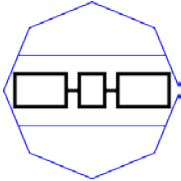
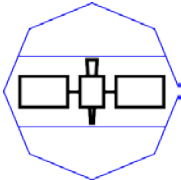
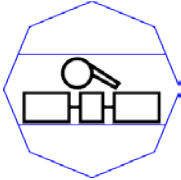
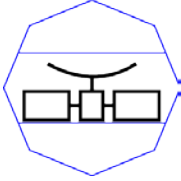
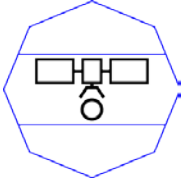
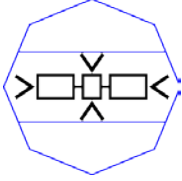
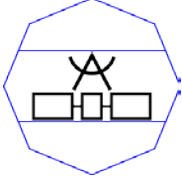
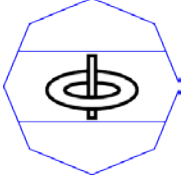
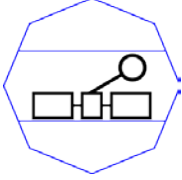
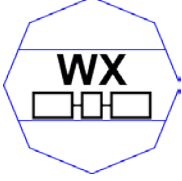
TABLE B-IV. Space equipment and platform sector 1 modifiers.

DESCRIPTION	CATEGORY	MODIFIER	REMARKS
LOW EARTH ORBIT (LEO) Symbol Set Code: 05 Code: 01	ORBIT		N/A
MEDIUM EARTH ORBIT (MEO) Symbol Set Code: 05 Code: 02	ORBIT		N/A
HIGH EARTH ORBIT (HEO) Symbol Set Code: 05 Code: 03	ORBIT		N/A
GEOSYNCHRONOUS ORBIT (GSO) Symbol Set Code: 05 Code: 04	ORBIT		N/A
GEOSTATIONARY ORBIT (GO) Symbol Set Code: 05 Code: 05	ORBIT		N/A
MOLNIYA ORBIT (MO) Symbol Set Code: 05 Code: 06	ORBIT		N/A

B.6.4 Space equipment and platform sector 2 modifiers. Space equipment and platform sector 2 modifiers denote sensor category. [Table B-V](#) lists space equipment and platform sector 2 modifiers and illustrates their placement within the bounding octagon.

TABLE B-V. Space equipment and platform sector 2 modifiers.

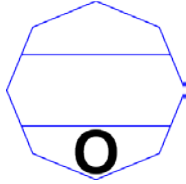
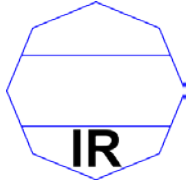
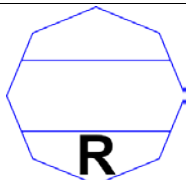
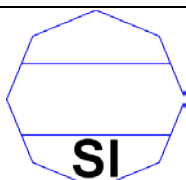
DESCRIPTION	CATEGORY	MODIFIER	REMARKS
OPTICAL Symbol Set Code: 05 Code: 01	SENSOR		Only used with satellite icons.
INFRARED Symbol Set Code: 05 Code: 02	SENSOR		Only used with satellite icons.
RADAR Symbol Set Code: 05 Code: 03	SENSOR		Only used with satellite icons.
SIGNALS INTELLIGENCE (SIGINT) Symbol Set Code: 05 Code: 04	SENSOR		Only used with satellite icons.

B.7 SPACE MISSILE SYMBOLS

B.7.1 Space missile symbols. This section includes the lists of icons and modifiers for building space missile symbols.

B.7.2 Space missile icons. [Table B-VI](#) depicts the lone space missile icon. The space missile icon requires the vertical bounding octagon.

TABLE B-VI. Space missile icon.

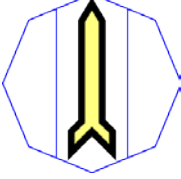
DESCRIPTION	ICON	REMARKS
MISSILE Type: Entity Symbol Set Code: 06 Code: 110000 Icon Type: Main		

B.7.3 Space missile sector 1 modifiers. Space missile sector 1 modifiers denote launch origin or missile class categories. [Table B-VII](#) lists missile sector 1 modifiers and illustrates their placement within the bounding octagon.

TABLE B-VII. Space missile sector 1 modifiers.

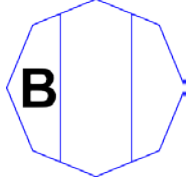
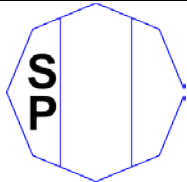
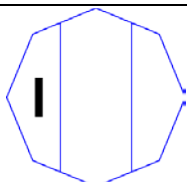
DESCRIPTION	CATEGORY	MODIFIER	REMARKS
BALLISTIC Symbol Set Code: 06 Code: 01	MISSILE CLASS		N/A
SPACE Symbol Set Code: 06 Code: 02	LAUNCH ORIGIN		N/A
INTERCEPTOR Symbol Set Code: 06 Code: 03	MISSILE CLASS		N/A

B.7.4 Space missile sector 2 modifiers. Space missile sector 2 modifiers denote projected missile destination, missile status, missile type, or missile range categories. [Table B-VIII](#) lists the missile sector 2 modifiers and illustrates their placement within the bounding octagon.

TABLE B-VIII. Space missile sector 2 modifiers.

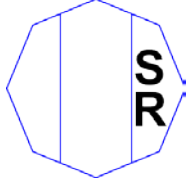
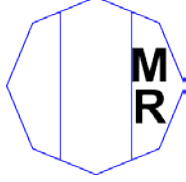
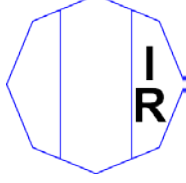
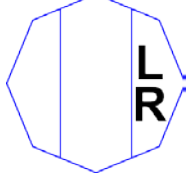
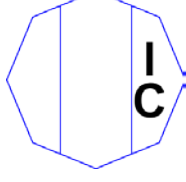
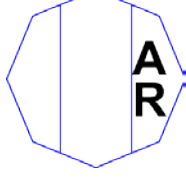
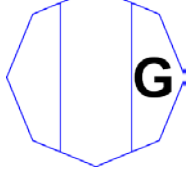
DESCRIPTION	CATEGORY	MODIFIER	REMARKS
SHORT RANGE Symbol Set Code: 06 Code: 01	MISSILE RANGE		1000km or less.
MEDIUM RANGE Symbol Set Code: 06 Code: 02	MISSILE RANGE		1000km to 3500km.
INTERMEDIATE RANGE Symbol Set Code: 06 Code: 03	MISSILE RANGE		1000km to 3500km.
LONG RANGE Symbol Set Code: 06 Code: 04	MISSILE RANGE		3500km to 5500km.
INTERCONTINENTAL Symbol Set Code: 06 Code: 05	MISSILE RANGE		5500km or greater.
ARROW Symbol Set Code: 06 Code: 06	MISSILE TYPE-BMD		Used with INTERCEPTOR modifier 1 only.
GROUND-BASED INTERCEPTOR (GBI) Symbol Set Code: 06 Code: 07	MISSILE TYPE-BMD		Used with INTERCEPTOR modifier 1 only.

MIL-STD-2525D - APPENDIX B

TABLE B-VIII. Space missile sector 2 modifiers - Continued.

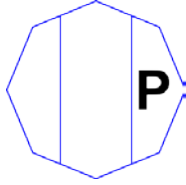
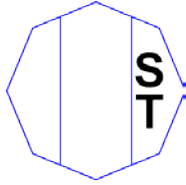
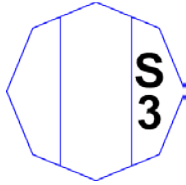
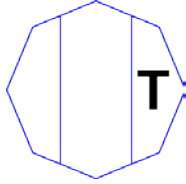
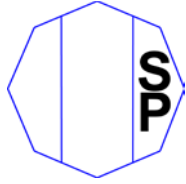
DESCRIPTION	CATEGORY	MODIFIER	REMARKS
PATRIOT Symbol Set Code: 06 Code: 08	MISSILE TYPE-BMD		Used with INTERCEPTOR modifier 1 only.
STANDARD MISSILE - TERMINAL PHASE (SM-T) Symbol Set Code: 06 Code: 09	MISSILE TYPE-BMD		Used with INTERCEPTOR modifier 1 only.
STANDARD MISSILE - 3 (SM-3) Symbol Set Code: 06 Code: 10	MISSILE TYPE-BMD		Used with INTERCEPTOR modifier 1 only.
TERMINAL HIGH-ALTITUDE AREA DEFENSE (THAAD) Symbol Set Code: 06 Code: 11	MISSILE TYPE-BMD		Used with INTERCEPTOR modifier 1 only.
SPACE Symbol Set Code: 06 Code: 12	LAUNCH ORIGIN		N/A

APPENDIX C - AIR SYMBOLS

C.1 SCOPE

C.1.1 Scope. This appendix addresses symbols that support air equipment and weapons in the C2 domain. The tables in this appendix present the icons and modifiers for the air domain. This appendix is divided into two sections ([see figure C-1](#)): 1) equipment and platform symbols ([see section C.6](#)) and 2) missile symbols ([see section C.7](#)). This appendix is a mandatory part of the standard. The information contained herein is intended for compliance.

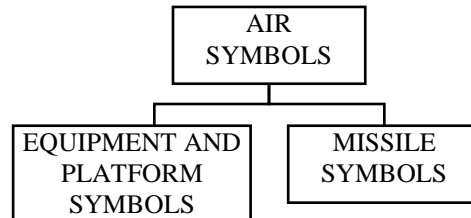

FIGURE C-1. Air appendix sections.

C.2 APPLICABLE DOCUMENTS

Specific documents in [2.2](#) of this standard apply to this appendix.

C.3 DEFINITIONS

The definitions in [section 3](#) of this standard apply to this appendix.

C.4 GENERAL REQUIREMENTS

C.4.1 Organization. This appendix contains technical specifications, a symbol coding scheme, a symbology hierarchy and air symbology.

C.5 DETAILED REQUIREMENTS

C.5.1 Technical specifications. Composition, construction and display of symbols are explained in the detailed requirements section of the standard.

C.5.2 Symbol identification coding scheme. A symbol identification code (SIDC) is a numeric string that may be used to provide the unique identifier necessary to display or exchange symbol information between MIL-STD-2525 compliant systems. Refer to [Appendix A](#) for SIDC positions and descriptions.

C.5.3 Composition of air symbols. A standard method for constructing symbols is presented. Refer to [5.3.8](#) for an explanation of symbol composition. [Figure C-2](#) shows an example of an air equipment symbol.

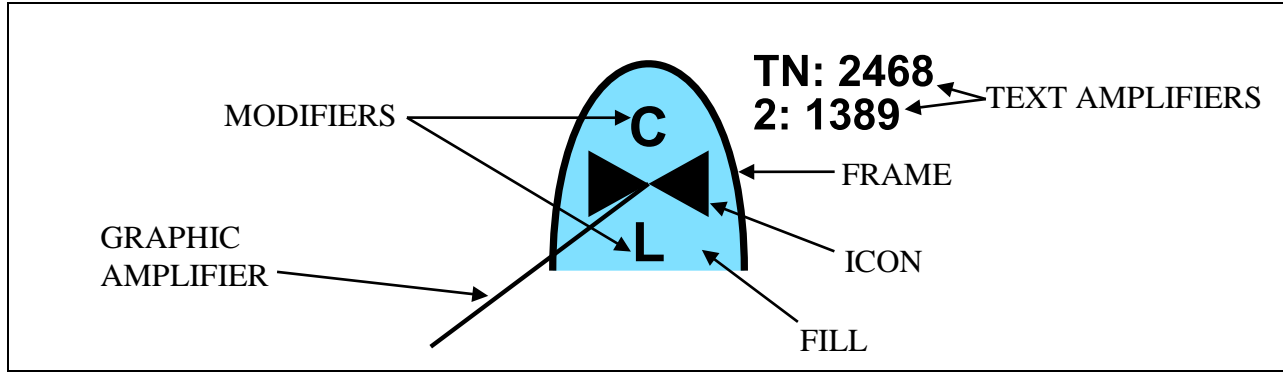

FIGURE C-2. Air symbol components.

C.5.3.1 Symbol building process. [Table C-I](#) depicts the symbol building process for air symbols. The process is identical for icons and modifiers requiring the vertical bounding octagon.

TABLE C-I. Air symbol building process.

STEP	DESCRIPTION	EXAMPLE
1.	Choose the frame that matches the standard identity of the object from the air column in tables I, II, or III. In this example, the standard identity is friendly. The example depicts a “friendly air track.”	
2.	Choose an icon for the main sector of the bounding octagon. In this example, the icon is “military rotary-wing,” an air entity type. The example depicts a “friendly military rotary-wing aircraft.”	
3.	If required, choose a modifier to depict an additional characteristic of the icon. In this example, the modifier is “cargo,” a sector 1 modifier. The example depicts a “friendly military rotary-wing cargo aircraft.”	

TABLE C-I. Air symbol building process - Continued.

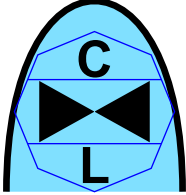
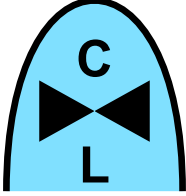
STEP	DESCRIPTION	EXAMPLE
4.	<p>If required, choose a modifier to depict another characteristic of the icon. In this example, the modifier is “light,” a sector 2 modifier.</p> <p>The example depicts a “friendly military rotary-wing cargo aircraft with light cargo capacity.”</p>	
5.	<p>The finished symbol will appear as shown in the example.</p>	

C.5.3.2 Icons and modifiers. All icons shall be placed within the main sector of the bounding octagon (see table C-I). When depicted, modifiers shall be placed in sectors 1 or 2 as appropriate (see table C-I). Only one modifier may be placed in each sector at a given time. Multiple modifiers in the same position are prohibited due to legibility concerns.

C.5.3.3 Amplifiers.

C.5.3.3.1 Heading. The purpose of the static text amplifiers described in this appendix is to standardize the display of additional alphanumeric information on identity, movement and location and capabilities. See 5.1.6 for more information on amplifiers.

Figure C-3 shows the placement of air symbol amplifiers around the friend symbol frame.

Table C-II provides descriptions and formats of each amplifier.

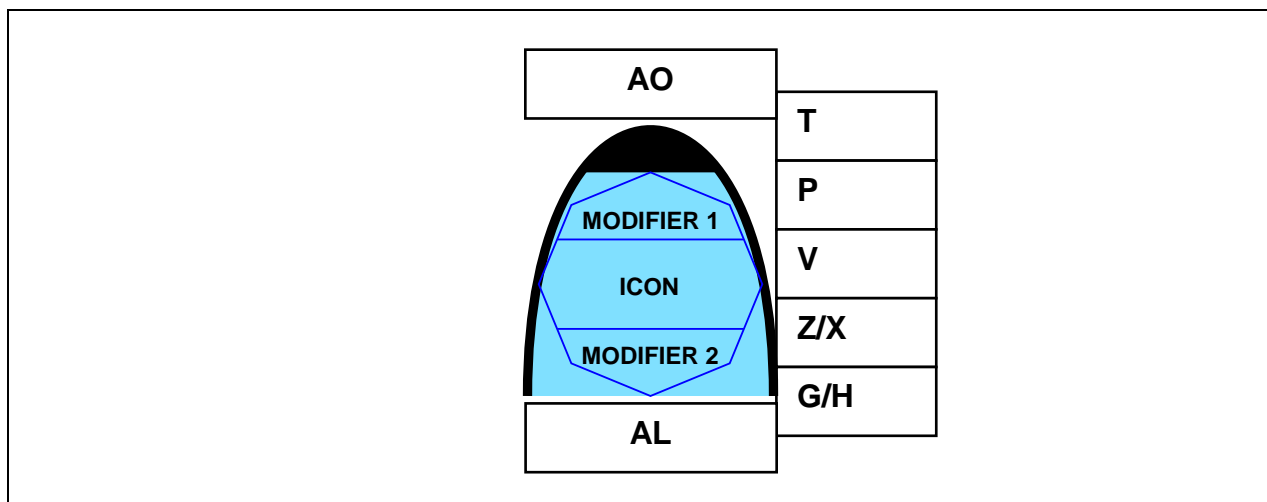

FIGURE C-3. Placement of air symbol amplifiers.

TABLE C-II. Descriptions and formats of air symbol amplifiers.

FIELD	FIELD TITLE	DESCRIPTION	FORMAT
A	Air Vehicle/Air Vehicle Type Icon	Uses icon and sector modifiers	
G	Staff Comments	A text amplifier for units, equipment and installations; content is implementation specific.	
H	Additional Information	A text amplifier for units, equipment and installations; content is implementation specific.	
P	IFF/SIF	A text amplifier displaying IFF/SIF Identification modes and codes. Display priority: Mode 5, Mode S, Mode 4, Mode 2, Mode 3.	Mode 2 Prefix: 2:#### Example: 2:1234
T	Unique Designation (Track Number)	A text amplifier for units, equipment and installations that uniquely identifies a particular symbol or track number.	Prefix = TN:##### Example: TN:13579
V	Type	A text amplifier for equipment that indicates types of equipment.	
X	Altitude	A text amplifier for units that displays altitude/ flight level. See 5.3.6.5 for content.	Measurement units shall be displayed within the string Examples: 1500MSL FL150
Z	Speed	A text amplifier for units and equipment that displays velocity as set forth in MIL-STD-6040 .	
AL	Operational Condition	A graphic amplifier for equipment or installations that indicates operational condition or capacity.	Operational Condition amplifier, if used, shall be comprised of only one color. Ex. Aircraft: Red - damaged, Green – fully capable Ex: Missile: Red – imminent threat, Green – no threat
AO	Engagement Bar	A graphic amplifier placed immediately atop the symbol. May denote, 1) local/remote status; 2) engagement status; and 3) weapon type.	A:BBB-CC, where A = remote/local BBB = engagement status CC = weapon asset

C.5.3.3.2 Graphic amplifiers. Graphic amplifiers can be static, located in a fixed position in relation to a track's symbol, or dynamic and move about the symbol based on the track's characteristics. [See 5.1.6](#) for more information on amplifiers, including examples of dynamic amplifiers.

C.6 AIR EQUIPMENT AND PLATFORM SYMBOLS

C.6.1 Air equipment and platform symbols. This section includes the lists of icons and modifiers for building air equipment and platform symbols.

C.6.2 Air equipment and platform icons. [Table C-III](#) depicts air equipment and platform icons. Military symbols are depicted with black-filled icons, whereas civilian symbols are depicted with white-filled icons.

TABLE C-III. Air equipment and platform icons.

DESCRIPTION	ICON	REMARKS
MILITARY Type: Entity Symbol Set Code: 01 Code: 110000		This symbol shall not be displayed on a C2 system but may be displayed for training or hierarchal explanation purposes.
FIXED-WING Type: Entity Type Entity: MILITARY Symbol Set Code: 01 Code: 110100		N/A
MEDICAL EVACUATION (MEDEVAC) Type: Entity Subtype Entity/Entity Type: MILITARY/FIXED-WING Symbol Set Code: 01 Code: 110101		N/A
ATTACK/STRIKE Type: Entity Subtype Entity/Entity Type: MILITARY/FIXED-WING Symbol Set Code: 01 Code: 110102		N/A
BOMBER Type: Entity Subtype Entity/Entity Type: MILITARY/FIXED-WING Symbol Set Code: 01 Code: 110103		N/A
FIGHTER Type: Entity Subtype Entity/Entity Type: MILITARY/FIXED-WING Symbol Set Code: 01 Code: 110104		N/A

TABLE C-III. Air equipment and platform icons - Continued.

DESCRIPTION	ICON	REMARKS
FIGHTER/BOMBER Type: Entity Subtype Entity/Entity Type: MILITARY/ FIXED-WING Symbol Set Code: 01 Code: 110105		N/A
{Reserved for Future Use} Type: Entity Subtype Entity/Entity Type: MILITARY/ FIXED-WING Symbol Set Code: 01 Code: 110106	N/A	N/A
CARGO Type: Entity Subtype Entity/Entity Type: MILITARY/ FIXED-WING Symbol Set Code: 01 Code: 110107		N/A
ELECTRONIC/ COMBAT (EC)/JAMMER Type: Entity Subtype Entity/Entity Type: MILITARY/ FIXED-WING Symbol Set Code: 01 Code: 110108		N/A
TANKER Type: Entity Subtype Entity/Entity Type: MILITARY/ FIXED-WING Symbol Set Code: 01 Code: 110109		N/A
PATROL Type: Entity Subtype Entity/Entity Type: MILITARY/ FIXED-WING Symbol Set Code: 01 Code: 110110		N/A
RECONNAISSANCE Type: Entity Subtype Entity/Entity Type: MILITARY/ FIXED-WING Symbol Set Code: 01 Code: 110111		N/A

TABLE C-III. Air equipment and platform icons - Continued.



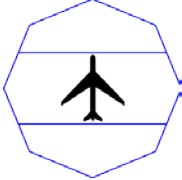
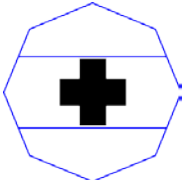
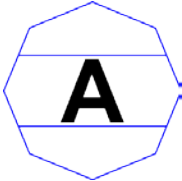
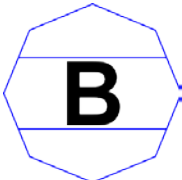
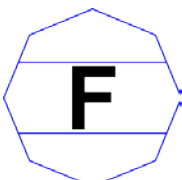

DESCRIPTION	ICON	REMARKS
TRAINER Type: Entity Subtype Entity/Entity Type: MILITARY/ FIXED-WING Symbol Set Code: 01 Code: 110112		N/A
UTILITY Type: Entity Subtype Entity/Entity Type: MILITARY/ FIXED-WING Symbol Set Code: 01 Code: 110113		N/A
VSTOL Type: Entity Subtype Entity/Entity Type: MILITARY/ FIXED-WING Symbol Set Code: 01 Code: 110114		N/A
AIRBORNE COMMAND POST (ACP) Type: Entity Subtype Entity/Entity Type: MILITARY/ FIXED-WING Symbol Set Code: 01 Code: 110115		N/A
AIRBORNE EARLY WARNING (AEW) Type: Entity Subtype Entity/Entity Type: MILITARY/ FIXED-WING Symbol Set Code: 01 Code: 110116		N/A
ANTISURFACE WARFARE Type: Entity Subtype Entity/Entity Type: MILITARY/ FIXED-WING Symbol Set Code: 01 Code: 110117		N/A
ANTISUBMARINE WARFARE Type: Entity Subtype Entity/Entity Type: MILITARY/ FIXED-WING Symbol Set Code: 01 Code: 110118		N/A

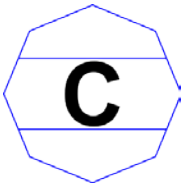
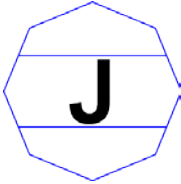
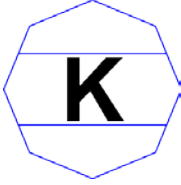
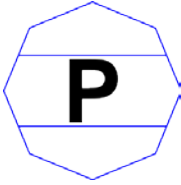
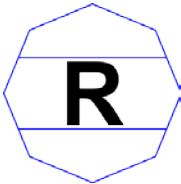
TABLE C-III. Air equipment and platform icons - Continued.



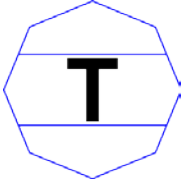
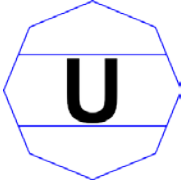
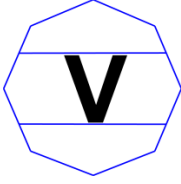



DESCRIPTION	ICON	REMARKS
COMMUNICATIONS Type: Entity Subtype Entity/Entity Type: MILITARY/ FIXED-WING Symbol Set Code: 01 Code: 110119		N/A
COMBAT SEARCH AND RESCUE (CSAR) Type: Entity Subtype Entity/Entity Type: MILITARY/ FIXED-WING Symbol Set Code: 01 Code: 110120		N/A
ELECTRONIC SUPPORT (ES) Type: Entity Subtype Entity/Entity Type: MILITARY/ FIXED-WING Symbol Set Code: 01 Code: 110121		N/A
GOVERNMENT Type: Entity Subtype Entity/Entity Type: MILITARY/ FIXED-WING Symbol Set Code: 01 Code: 110122		N/A
MINE COUNTERMEASURES (MCM) Type: Entity Subtype Entity/Entity Type: MILITARY/ FIXED-WING Symbol Set Code: 01 Code: 110123		N/A
PERSONNEL RECOVERY Type: Entity Subtype Entity/Entity Type: MILITARY/ FIXED-WING Symbol Set Code: 01 Code: 110124		N/A
SEARCH AND RESCUE Type: Entity Subtype Entity/Entity Type: MILITARY/ FIXED-WING Symbol Set Code: 01 Code: 110125		N/A

TABLE C-III. Air equipment and platform icons - Continued.







DESCRIPTION	ICON	REMARKS
SPECIAL OPERATIONS FORCES Type: Entity Subtype Entity/Entity Type: MILITARY/ FIXED-WING Symbol Set Code: 01 Code: 110126		N/A
ULTRA LIGHT Type: Entity Subtype Entity/Entity Type: MILITARY/ FIXED-WING Symbol Set Code: 01 Code: 110127		N/A
PHOTOGRAPHIC RECONNAISSANCE Type: Entity Subtype Entity/Entity Type: MILITARY/ FIXED-WING Symbol Set Code: 01 Code: 110128		N/A
VERY IMPORTANT PERSON (VIP) Type: Entity Subtype Entity/Entity Type: MILITARY/ FIXED-WING Symbol Set Code: 01 Code: 110129		N/A
SUPPRESSION OF ENEMY AIR DEFENSE Type: Entity Subtype Entity/Entity Type: MILITARY/ FIXED-WING Symbol Set Code: 01 Code: 110130		N/A
PASSENGER Type: Entity Subtype Entity/Entity Type: MILITARY/ FIXED-WING Symbol Set Code: 01 Code: 110131		N/A

TABLE C-III. Air equipment and platform icons - Continued.





DESCRIPTION	ICON	REMARKS
<p>ESCORT</p> <p>Type: Entity Subtype Entity/Entity Type: MILITARY/ FIXED-WING Symbol Set Code: 01 Code: 110132</p>		N/A
<p>ELECTRONIC ATTACK (EA)</p> <p>Type: Entity Subtype Entity/Entity Type: MILITARY/ FIXED-WING Symbol Set Code: 01 Code: 110133</p>		N/A
<p>ROTARY-WING</p> <p>Type: Entity Type Entity: MILITARY Symbol Set Code: 01 Code: 110200</p>		N/A
<p>UNMANNED AIRCRAFT (UA)/UNMANNED AERIAL VEHICLE (UAV)/UNMANNED AIRCRAFT SYSTEM (UAS)/REMOTE PILOTED VEHICLE (RPV)</p> <p>Type: Entity Type Entity: MILITARY Symbol Set Code: 01 Code: 110300</p>		N/A
<p>VERTICAL-TAKEOFF UAV (VT-UAV)</p> <p>Type: Entity Type Entity: MILITARY Symbol Set Code: 01 Code: 110400</p>		N/A
<p>LIGHTER THAN AIR</p> <p>Type: Entity Type Entity: MILITARY Symbol Set Code: 01 Code: 110500</p>		N/A
<p>AIRSHIP</p> <p>Type: Entity Type Entity: MILITARY Symbol Set Code: 01 Code: 110600</p>		N/A

TABLE C-III. Air equipment and platform icons - Continued.



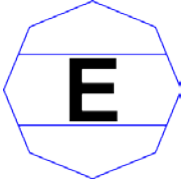

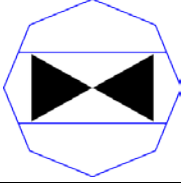

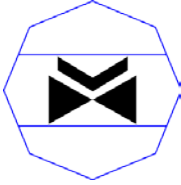
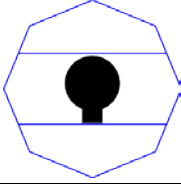
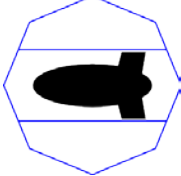
DESCRIPTION	ICON	REMARKS
<p>TETHERED LIGHTER THAN AIR</p> <p>Type: Entity Type Entity: MILITARY Symbol Set Code: 01 Code: 110700</p>		<p>N/A</p>
<p>CIVILIAN</p> <p>Type: Entity Symbol Set Code: 01 Code: 120000</p>		<p>This symbol shall not be displayed on a C2 system but may be displayed for training or hierarchal explanation purposes.</p>
<p>FIXED-WING</p> <p>Type: Entity Type Entity: CIVILIAN Symbol Set Code: 01 Code: 120100</p>		<p>N/A</p>
<p>ROTARY-WING</p> <p>Type: Entity Type Entity: CIVILIAN Symbol Set Code: 01 Code: 120200</p>		<p>N/A</p>
<p>UNMANNED AIRCRAFT (UA)/UNMANNED AERIAL VEHICLE (UAV)/UNMANNED AIRCRAFT SYSTEM (UAS)/REMOTE PILOTED VEHICLE</p> <p>Type: Entity Type Entity: CIVILIAN Symbol Set Code: 01 Code: 120300</p>		<p>N/A</p>
<p>LIGHTER THAN AIR</p> <p>Type: Entity Type Entity: CIVILIAN Symbol Set Code: 01 Code: 120400</p>		<p>N/A</p>
<p>AIRSHIP</p> <p>Type: Entity Type Entity: CIVILIAN Symbol Set Code: 01 Code: 120500</p>		<p>N/A</p>

TABLE C-III. Air equipment and platform icons - Continued.

DESCRIPTION	ICON	REMARKS
TETHERED LIGHTER THAN AIR Type: Entity Type Entity: CIVILIAN Symbol Set Code: 01 Code: 120600		N/A
WEAPON Type: Entity Symbol Set Code: 01 Code: 130000		This symbol shall not be displayed on a C2 system but may be displayed for training or hierarchal explanation purposes.
BOMB Type: Entity Type Entity: WEAPON Symbol Set Code: 01 Code: 130100		N/A
DECOY Type: Entity Type Entity: WEAPON Symbol Set Code: 01 Code: 130200		N/A
MANUAL TRACK Type: Entity (Local) Symbol Set Code: 10 Code: 140000 Icon Type: Full Octagon		N/A

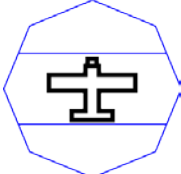
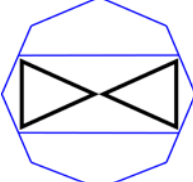
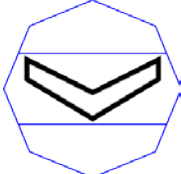
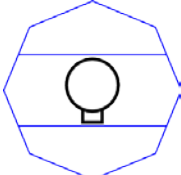
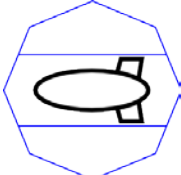
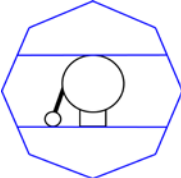
C.6.3 Air equipment and platform sector 1 modifiers. Air equipment and platform sector 1 modifiers denote aircraft type and mission area categories. [Table C-IV](#) lists air equipment and platform sector 1 modifiers and illustrates their placement within the bounding octagon.

TABLE C-IV. Air equipment and platform sector 1 modifiers.

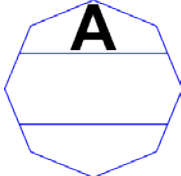
DESCRIPTION	CATEGORY	MODIFIER	REMARKS
ATTACK/STRIKE Symbol Set Code: 01 Code: 01	MILITARY AIRCRAFT TYPE		N/A

MIL-STD-2525D - APPENDIX C

TABLE C-IV. Air equipment and platform sector 1 modifiers - Continued.

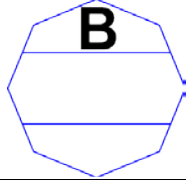
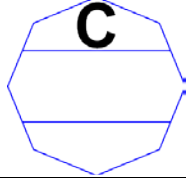
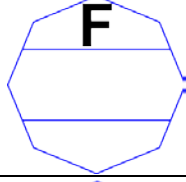
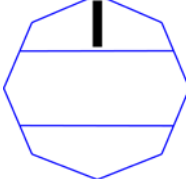
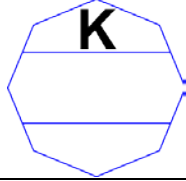
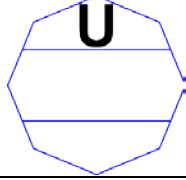
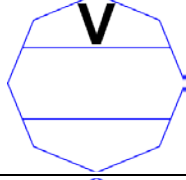
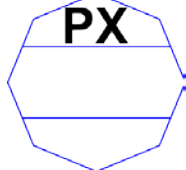
DESCRIPTION	CATEGORY	MODIFIER	REMARKS
BOMBER Symbol Set Code: 01 Code: 02	MILITARY AIRCRAFT TYPE		N/A
CARGO Symbol Set Code: 01 Code: 03	AIRCRAFT TYPE		N/A
FIGHTER Symbol Set Code: 01 Code: 04	MILITARY AIRCRAFT TYPE		N/A
INTERCEPTOR Symbol Set Code: 01 Code: 05	MILITARY AIRCRAFT TYPE		APP-6
TANKER Symbol Set Code: 01 Code: 06	AIRCRAFT TYPE		N/A
UTILITY Symbol Set Code: 01 Code: 07	AIRCRAFT TYPE		N/A
VSTOL/VTOL Symbol Set Code: 01 Code: 08	AIRCRAFT TYPE		N/A
PASSENGER Symbol Set Code: 01 Code: 09	AIRCRAFT TYPE		N/A

MIL-STD-2525D - APPENDIX C

TABLE C-IV. Air equipment and platform sector 1 modifiers - Continued.

DESCRIPTION	CATEGORY	MODIFIER	REMARKS
ULTRA LIGHT Symbol Set Code: 01 Code: 10	AIRCRAFT TYPE		N/A
AIRBORNE COMMAND POST (ACP) Symbol Set Code: 01 Code: 11	MILITARY AIRCRAFT TYPE		N/A
AIRBORNE EARLY WARNING (AEW) Symbol Set Code: 01 Code: 12	MILITARY AIRCRAFT TYPE		N/A
GOVERNMENT Symbol Set Code: 01 Code: 13	AIRCRAFT TYPE		N/A
MEDICAL EVACUATION (MEDEVAC) Symbol Set Code: 01 Code: 14	MISSION AREA		N/A
ESCORT Symbol Set Code: 01 Code: 15	MILITARY MISSION AREA		N/A
ELECTRONIC COMBAT (EC)/JAMMER Symbol Set Code: 01 Code: 16	MILITARY MISSION AREA		N/A
PATROL Symbol Set Code: 01 Code: 17	MISSION AREA		N/A

TABLE C-IV. Air equipment and platform sector 1 modifiers - Continued.



DESCRIPTION	CATEGORY	MODIFIER	REMARKS
RECONNAISSANCE Symbol Set Code: 01 Code: 18	MISSION AREA		N/A
TRAINER Symbol Set Code: 01 Code: 19	MISSION AREA		N/A
PHOTOGRAPHIC (RECONNAISSANCE) Symbol Set Code: 01 Code: 20	MISSION AREA		N/A
PERSONNEL RECOVERY Symbol Set Code: 01 Code: 21	MISSION AREA		N/A
ANTISUBMARINE WARFARE Symbol Set Code: 01 Code: 22	MILITARY MISSION AREA		N/A
COMMUNICATIONS Symbol Set Code: 01 Code: 23	MISSION AREA		N/A
ELECTRONIC SUPPORT (ES) Symbol Set Code: 01 Code: 24	MILITARY MISSION AREA		N/A
MINE COUNTERMEASURES (MCM) Symbol Set Code: 01 Code: 25	MILITARY MISSION AREA		N/A

TABLE C-IV. Air equipment and platform sector 1 modifiers - Continued.

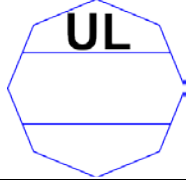
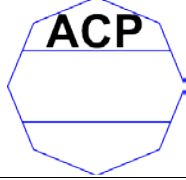
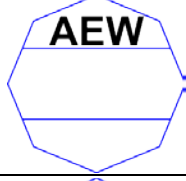
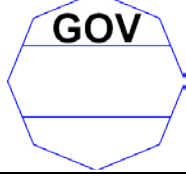
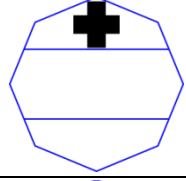
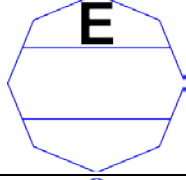
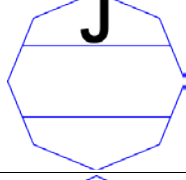
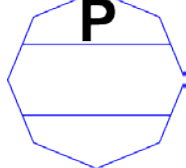

DESCRIPTION	CATEGORY	MODIFIER	REMARKS
SEARCH AND RESCUE Symbol Set Code: 01 Code: 26	MISSION AREA		N/A
SPECIAL OPERATIONS FORCES (SOF) Symbol Set Code: 01 Code: 27	MILITARY MISSION AREA		N/A
SURFACE WARFARE Symbol Set Code: 01 Code: 28	MILITARY MISSION AREA		N/A
VERY IMPORTANT PERSON (VIP) TRANSPORT Symbol Set Code: 01 Code: 29	MISSION AREA		N/A
COMBAT SEARCH AND RESCUE (CSAR) Symbol Set Code: 01 Code: 30	MILITARY MISSION AREA		N/A
SUPPRESSION OF ENEMY AIR DEFENSE Symbol Set Code: 01 Code: 31	MILITARY MISSION AREA		APP-6
ANTISURFACE WARFARE Symbol Set Code: 01 Code: 32	MILITARY MISSION AREA		N/A
FIGHTER/BOMBER Symbol Set Code: 01 Code: 33	MILITARY AIRCRAFT TYPE		N/A

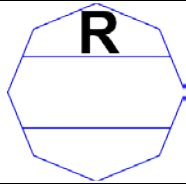
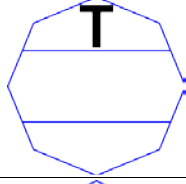
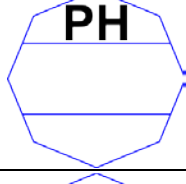
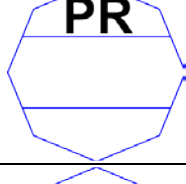
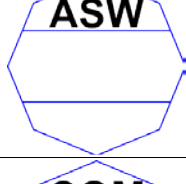
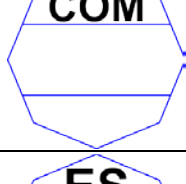
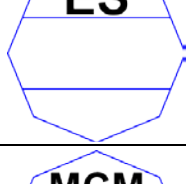
TABLE C-IV. Air equipment and platform sector 1 modifiers - Continued.

DESCRIPTION	CATEGORY	MODIFIER	REMARKS
INTENSIVE CARE Symbol Set Code: 01 Code: 34	MISSION AREA		N/A
ELECTRONIC ATTACK (EA) Symbol Set Code: 01 Code: 35	MILITARY MISSION AREA		N/A
MULTIMISSION Symbol Set Code: 01 Code: 36	MISSION AREA		N/A
HIJACKING Symbol Set Code: 01 Code: 37	CRIME		N/A
ASW HELO- LAMPS Symbol Set Code: 01 Code: 38	MISSION AREA		Must be paired in conjunction with rotary wing icon
ASW HELO – SH-60R Symbol Set Code: 01 Code: 39	MISSION AREA		Must be paired in conjunction with rotary wing icon

C.6.4 Air equipment and platform sector 2 modifiers. Air equipment and platform sector 2 modifiers denote capacity, re-fueling capability, range and track link availability categories. [Table C-V](#) lists air equipment and platform sector 2 modifiers and illustrates their placement within the bounding octagon.

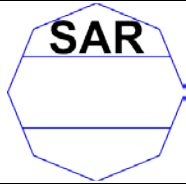
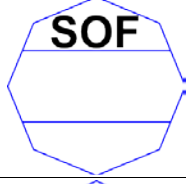
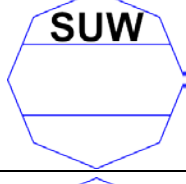
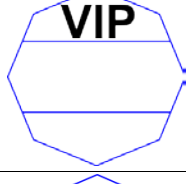
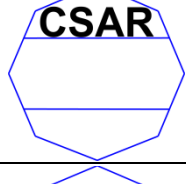
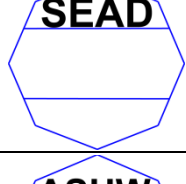
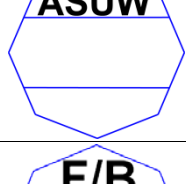
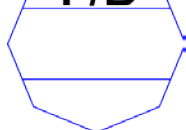
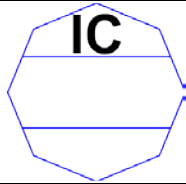
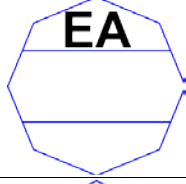
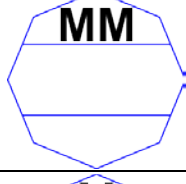
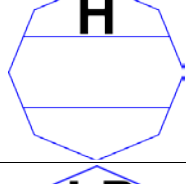
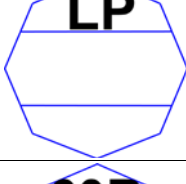
TABLE C-V. Air equipment and platform sector 2 modifiers.

DESCRIPTION	CATEGORY	MODIFIER	REMARKS
HEAVY Symbol Set Code: 01 Code: 01	CARGO/TRANSPORT CAPACITY		N/A
MEDIUM Symbol Set Code: 01 Code: 02	CARGO/TRANSPORT CAPACITY		N/A
LIGHT Symbol Set Code: 01 Code: 03	CARGO/TRANSPORT CAPACITY		N/A
BOOM-ONLY Symbol Set Code: 01 Code: 04	RE-FUELING CAPABILITY		Used with TANKER only.
DROGUE-ONLY Symbol Set Code: 01 Code: 05	RE-FUELING CAPABILITY		Used with TANKER only.
BOOM AND DROGUE Symbol Set Code: 01 Code: 06	RE-FUELING CAPABILITY		Used with TANKER only.
CLOSE RANGE Symbol Set Code: 01 Code: 07	RANGE		N/A
SHORT RANGE Symbol Set Code: 01 Code: 08	RANGE		N/A

TABLE C-V. Air equipment and platform sector 2 modifiers - Continued.

DESCRIPTION	CATEGORY	MODIFIER	REMARKS
MEDIUM RANGE Symbol Set Code: 01 Code: 09	RANGE		N/A
LONG RANGE Symbol Set Code: 01 Code: 10	RANGE		N/A
DOWNLINKED Symbol Set Code: 01 Code: 11	TRACK LINK AVAILABILITY		N/A

C.7 AIR MISSILE SYMBOLS

C.7.1 Air missile symbols. This section includes the lists of icons and modifiers for building air missile symbols.

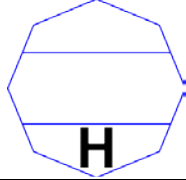
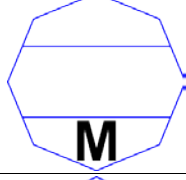
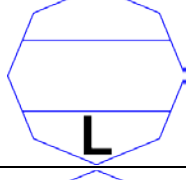
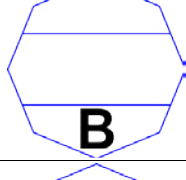
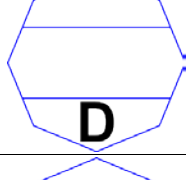
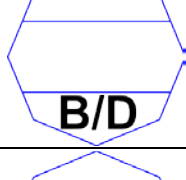
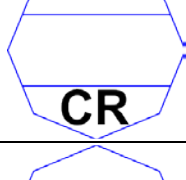
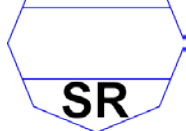
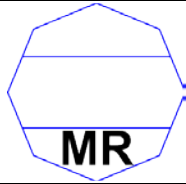
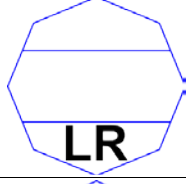
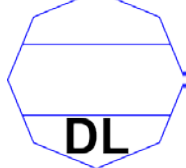
C.7.2 Air missile icons. [Table C-VI](#) depicts the lone air missile icon. The air missile icon requires the vertical bounding octagon.

TABLE C-VI. Air missile icon.

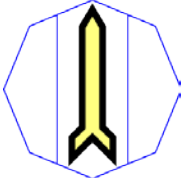
DESCRIPTION	ICON	REMARKS
MISSILE Type: Entity Symbol Set Code: 02 Code: 110000		

C.7.3 Air missile sector 1 modifiers. Air missile sector 1 modifiers denote launch origin or missile class categories. [Table C-VII](#) lists missile sector 1 modifiers and illustrates their placement within the bounding octagon.

TABLE C-VII. Air missile sector 1 modifiers.

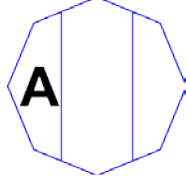
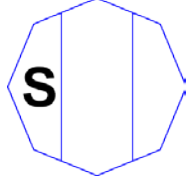
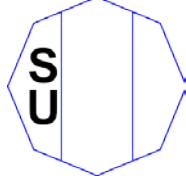
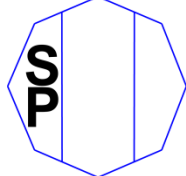
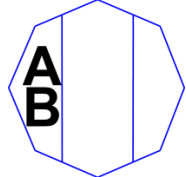
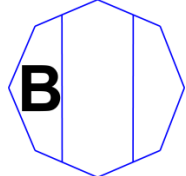
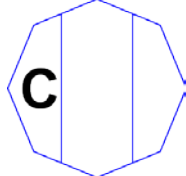
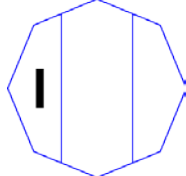
DESCRIPTION	CATEGORY	MODIFIER	REMARKS
AIR Symbol Set Code: 02 Code: 01	LAUNCH ORIGIN		N/A
SURFACE Symbol Set Code: 02 Code: 02	LAUNCH ORIGIN		N/A
SUBSURFACE Symbol Set Code: 02 Code: 03	LAUNCH ORIGIN		N/A
SPACE Symbol Set Code: 02 Code: 04	LAUNCH ORIGIN		N/A
ANTI-BALLISTIC Symbol Set Code: 02 Code: 05	MISSILE CLASS		N/A
BALLISTIC Symbol Set Code: 02 Code: 06	MISSILE CLASS		N/A
CRUISE Symbol Set Code: 02 Code: 07	MISSILE CLASS		N/A
INTERCEPTOR Symbol Set Code: 02 Code: 08	MISSILE CLASS		N/A

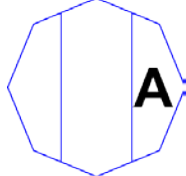
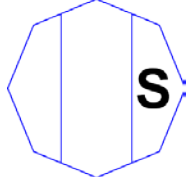
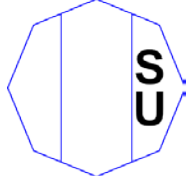
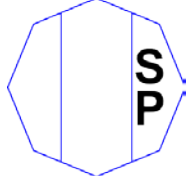
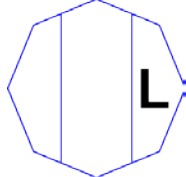
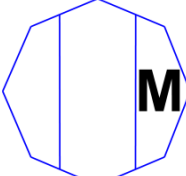
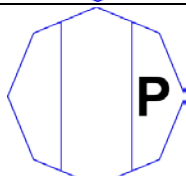

C.7.4 Air missile sector 2 modifiers. Air missile sector 2 modifiers denote projected missile destination, missile status, missile type-BMD, missile type-AAW, or missile range categories. [Table C-VIII](#) lists the missile sector 2 modifiers and illustrates their placement within the bounding octagon.

TABLE C-VIII. Air missile sector 2 modifiers.

DESCRIPTION	CATEGORY	MODIFIER	REMARKS
AIR Symbol Set Code: 02 Code: 01	MISSILE DESTINATION		N/A
SURFACE Symbol Set Code: 02 Code: 02	MISSILE DESTINATION		N/A
SUBSURFACE Symbol Set Code: 02 Code: 03	MISSILE DESTINATION		N/A
SPACE Symbol Set Code: 02 Code: 04	MISSILE DESTINATION		N/A
LAUNCHED Symbol Set Code: 02 Code: 05	MISSILE STATUS		N/A
MISSILE Symbol Set Code: 02 Code: 06	MISSILE STATUS		APP-6
PATRIOT Symbol Set Code: 02 Code: 07	MISSILE TYPE-BMD		Used with INTERCEPTOR modifier 1 only.

MIL-STD-2525D - APPENDIX C

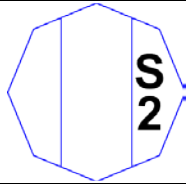
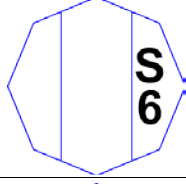
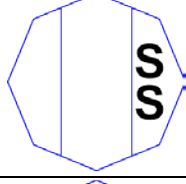
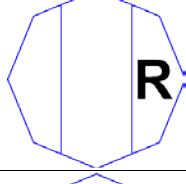
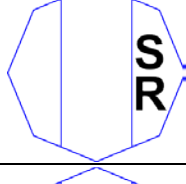
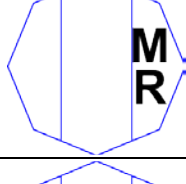
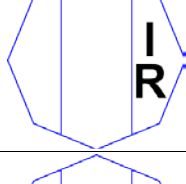
TABLE C-VIII. Air missile sector 2 modifiers - Continued.

DESCRIPTION	CATEGORY	MODIFIER	REMARKS
STANDARD MISSILE - 2 (SM-2) Symbol Set Code: 02 Code: 08	MISSILE TYPE-AAW		Used with INTERCEPTOR modifier 1 only.
STANDARD MISSILE - 6 (SM-6) Symbol Set Code: 02 Code: 09	MISSILE TYPE-AAW		Used with INTERCEPTOR modifier 1 only.
EVOLVED SEA SPARROW MISSILE (ESSM) Symbol Set Code: 02 Code: 10	MISSILE TYPE-AAW		Used with INTERCEPTOR modifier 1 only.
ROLLING AIRFRAME MISSILE (RAM) Symbol Set Code: 02 Code: 11	MISSILE TYPE-AAW		Used with INTERCEPTOR modifier 1 only.
SHORT RANGE Symbol Set Code: 02 Code: 12	MISSILE RANGE		1000km or less.
MEDIUM RANGE Symbol Set Code: 02 Code: 13	MISSILE RANGE		1000km to 3500km. Typically used in reference to surface-to-air missile
INTERMEDIATE RANGE Symbol Set Code: 02 Code: 14	MISSILE RANGE		1000km to 3500km. Typically used in reference to ballistic missile
LONG RANGE Symbol Set Code: 02 Code: 15	MISSILE RANGE		3500km to 5500km.

MIL-STD-2525D - APPENDIX C

TABLE C-VIII. Air missile sector 2 modifiers - Continued.

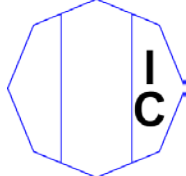
DESCRIPTION	CATEGORY	MODIFIER	REMARKS
INTERCONTINENTAL Symbol Set Code: 02 Code: 16	MISSILE RANGE		5500km or greater.

PAGE INTENTIONALLY LEFT BLANK

APPENDIX D - LAND SYMBOLS

D.1 SCOPE

D.1.1 Scope. This appendix addresses symbols that support land units, equipment and installations in the C2 domain. The tables in this appendix present the icons and modifiers for the land domain. This appendix is divided into four sections ([see figure D-1](#)): 1) unit symbols (see section C.6), 2) civilian unit/organization symbols (see section C.7), 3) equipment symbols (see section C.8) and 4) installation symbols (see section C.9). This appendix is a mandatory part of the standard. The information contained herein is intended for compliance.

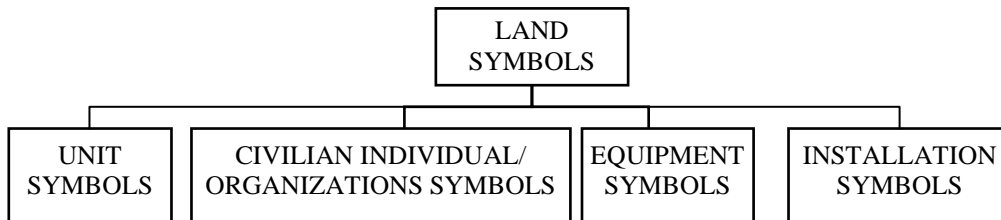

FIGURE D-1. Land appendix sections.

D.2 APPLICABLE DOCUMENTS

Specific documents in [2.2](#) of this standard apply to this appendix.

D.3 DEFINITIONS

The definitions in [section 3](#) of this standard apply to this appendix.

D.4 GENERAL REQUIREMENTS

D.4.1 Organization. This appendix contains technical specifications, a symbol coding scheme, a symbology hierarchy and land symbology.

D.5 DETAILED REQUIREMENTS

D.5.1 Technical specifications. Composition, construction and display of symbols are explained in the detailed requirements section of the standard.

D.5.2 Symbol identification coding scheme. A symbol identification code (SIDC) is a numeric string that may be used to provide the unique identifier necessary to display or exchange symbol information between MIL-STD-2525 compliant systems. Refer to [Appendix A](#) for SIDC positions and descriptions.

D.5.3 Composition of land symbols. A standard method for constructing symbols is presented. Refer to [5.3.8](#) for an explanation of symbol composition. [Figure D-2](#) shows an example of a land unit symbol.

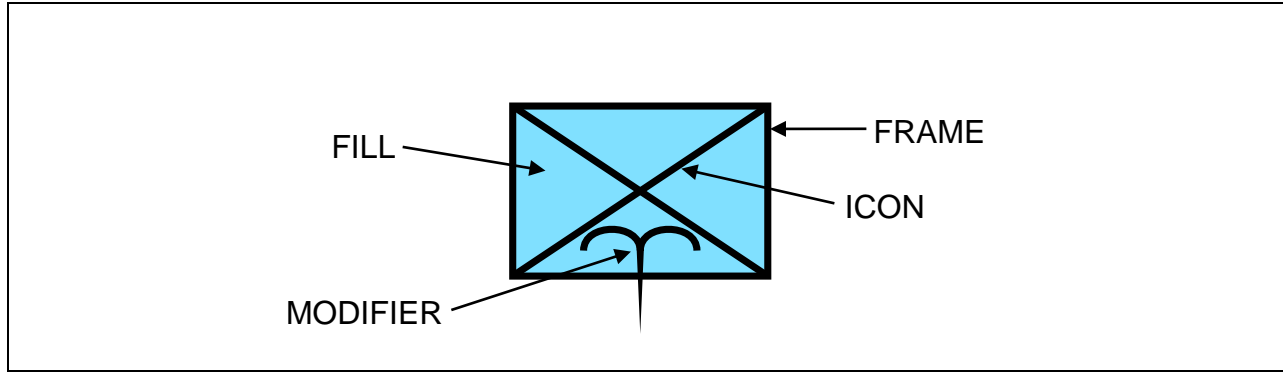

FIGURE D-2. Land symbol components.

D.5.3.1 Symbol building process. Table D-I depicts the symbol building process for land symbols. The process is identical for icons and modifiers requiring the vertical bounding octagon.

TABLE D-I. Land symbol building process.

STEP	DESCRIPTION	EXAMPLE
1.	Choose the frame that matches the standard identity and land symbol type of the object from the land columns in tables I, II, or III. In this example, the standard identity is friend and the land symbol type is unit. The example depicts a “friendly unit.”	
2.	Choose an icon for the symbol. In this example, the icon is “infantry,” a land entity type. The infantry icon is a full frame icon; therefore, the friend version of the infantry icon shall be used with the friend frame. If the frame were hostile, then the hostile version of the infantry icon would be used. The example depicts a “friendly infantry unit.”	
3.	If required, choose a modifier to depict an additional characteristic of the icon. In this example, the modifier is “airborne,” a sector 2 modifier. The example depicts a “friendly airborne infantry unit.”	

TABLE D-I. Land symbol building process - Continued.

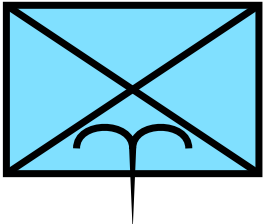
STEP	DESCRIPTION	EXAMPLE
4.	The finished symbol will appear as shown in the example.	

D.5.3.2 Icons and modifiers. All icons shall be placed within the main sector of the bounding octagon (see table D-I). When depicted, modifiers shall be placed in sectors 1 or 2 as appropriate (see table D-I). Only one modifier may be placed in each sector at a given time. Multiple modifiers in the same position are prohibited due to legibility concerns.

D.5.3.3 Amplifiers.

D.5.3.3.1 Text amplifiers. The purpose of the static text amplifiers described in this appendix is to standardize the display of additional alphanumeric information on identity, movement and location and capabilities. See 5.1.6 for more information on amplifiers. Figure D-3 shows the placement of land symbol amplifiers around the friend symbol frame. Table D-II provides descriptions and formats of each amplifier.

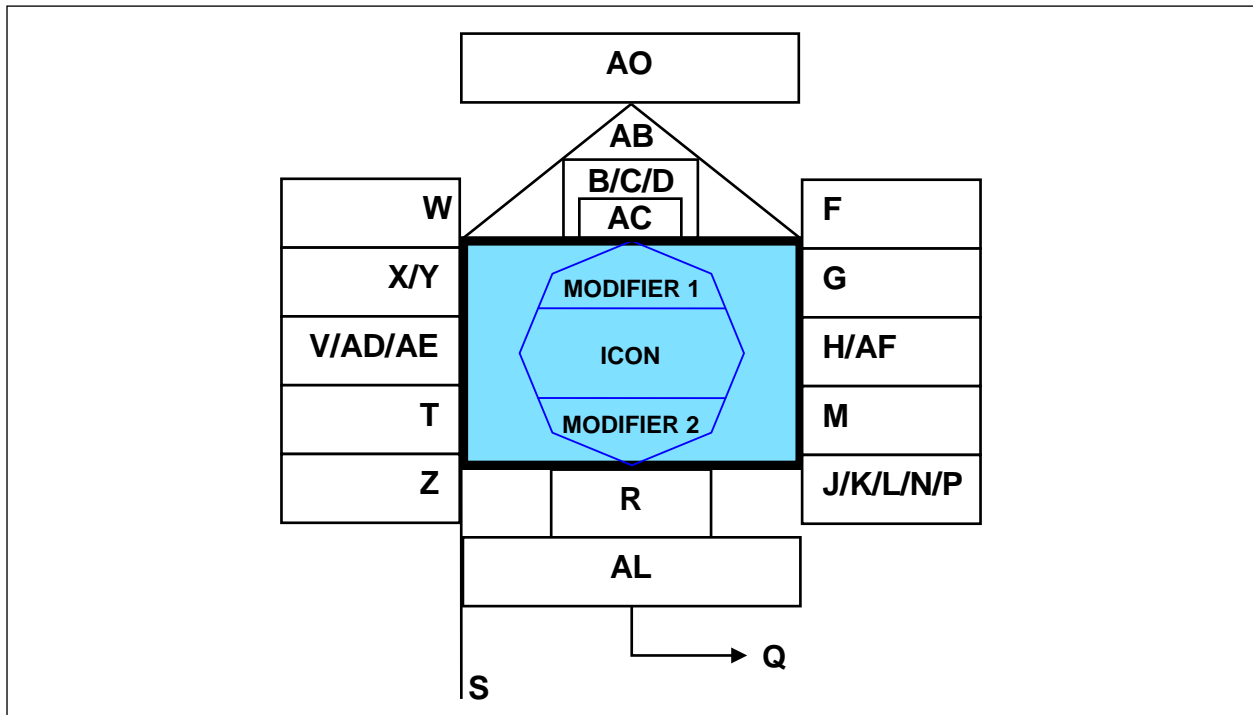

FIGURE D-3. Placement of land symbol amplifiers.

TABLE D-II. Descriptions and formats of land symbol amplifiers.

FIELD	FIELD TITLE	DESCRIPTION	FORMAT
A	Basic Branch/Function Icon	The innermost part of a symbol that represents a joint military object (see 5.3.4).	
B	Echelon	A graphic amplifier in a unit symbol that identifies command level (see table D-III below and figure 13 in the base document).	
C	Quantity	A text amplifier in an equipment symbol that identifies the number of items present.	
D	Task Force Indicator	A graphic amplifier that identifies a unit or an activities symbol as a task force (see 5.3.6.3 and figure 13 in the base document).	
F	Reinforced or Reduced	A text amplifier in a unit symbol that displays (+) for reinforced, (-) for reduced, (±) reinforced and reduced.	
G	Staff Comments	A text amplifier for units, equipment and installations; content is implementation specific.	
H	Additional Information	A text amplifier for units, equipment and installations; content is implementation specific.	
J ¹	Evaluation Rating	<p>A text amplifier for units, equipment and installations that consists of a single-letter reliability rating and a single digit credibility rating:</p> <p>Reliability Ratings: A-completely reliable B-usually reliable C-fairly reliable D-not usually reliable E-unreliable F-reliability cannot be judged.</p> <p>Credibility Ratings: 1-confirmed by other sources 2-probably true 3-possibly true 4-doubtfully true 5-improbable 6-truth cannot be judged.</p>	

TABLE D-II. Descriptions and formats of land symbol amplifiers - Continued.

FIELD	FIELD TITLE	DESCRIPTION	FORMAT
K	Combat Effectiveness	A text amplifier for units and installations that indicates effectiveness. The entries are: fully operational (FO) substantially operational (SO) marginally operational (MO) not operational (NO) unknown (UNK).	
L	Signature Equipment	A text amplifier for hostile equipment; “?” indicates detectable electronic signatures.	
M	Higher Formation	A text amplifier for units that indicates number or title of higher echelon command (corps are designated by Roman numerals).	
N	Hostile (Enemy)	A text amplifier for equipment; letters "ENY" denote hostile symbols.	
P	IFF/SIF	A text amplifier displaying IFF/SIF Identification modes and codes. Display priority: Mode 5, Mode S, Mode 4, Mode 2, Mode 3.	Mode 2 Prefix: 2:##### Example: 2:1234
Q	Direction of Movement Indicator	A graphic amplifier for units, equipment and installations that identifies the direction of movement or intended movement of an object (see 5.3.6.7 and figure 13 in the base document).	
R	Mobility Indicator	A graphic amplifier for equipment that depicts the mobility of an object (see 5.3.6.8 , figure 13 and table VIII in the base document).	
S	Headquarters Staff Indicator/Offset Location Indicator	Headquarters staff indicator: A graphic amplifier for units, equipment and installations that identifies a unit as a headquarters (see table D-III below and figure 13 in the base document). Offset location indicator: A graphic amplifier for units, equipment and installations used when placing an object away from its actual location (see 5.3.6.4 and figure 13 in the base document).	
T	Unique Designation (Track Number)	A text amplifier for units, equipment and installations that uniquely identifies a particular symbol or track number.	Prefix = TN:##### Example: TN:13579
V	Type	A text amplifier for equipment that indicates types of equipment.	

TABLE D-II. Descriptions and formats of land symbol amplifiers - Continued.

FIELD	FIELD TITLE	DESCRIPTION	FORMAT
W ²	Date-Time Group (DTG)	An alphanumeric designator for displaying a date-time group (DDHHMMSSZMONYYYY) or "O/O" for on order. The date-time group is composed of a group of six numeric digits with a time zone suffix and the standardized three-letter abbreviation for the month followed by four digits representing the year. The first pair of digits represents the day; the second pair, the hour; the third pair, the minutes. For automated systems, two digits may be added before the time zone suffix and after the minutes to designate seconds.	
X	Altitude/Depth	A text amplifier for units, equipment and installations that displays either altitude, flight level, depth for submerged objects, or height of equipment or structures on the ground. See 5.3.6.5 for content.	Measurement units shall be displayed within the string Examples: 1500MSL FL150
Y	Location	A text amplifier for units, equipment and installations that displays a symbol's location in degrees, minutes and seconds (or in UTM or other applicable display format).	
Z	Speed	A text amplifier for units and equipment that displays velocity as set forth in MIL-STD- 6040 .	
AA	Special C2 Headquarters	A text modifier for units; indicator is contained inside the frame. A named command such as SHAPE, PACOM, CENTCOM, joint, multinational, or coalition commands such as CJTF, JTF, MJTF.	
AB	Feint/Dummy Indicator	A graphic amplifier for units, equipment and installations that identifies an offensive or defensive unit intended to draw the enemy's attention away from the area of the main attack (see 5.3.6.3 and figure 13 in the base document).	
AC	Installation	A graphic amplifier for units, equipment and installations used to show that a particular symbol denotes an installation (see 5.3.6.1 and figure 13 in the base document).	
AD	Platform Type	Electronic intelligence notation (ELNOT) or communications intelligence notation (CENOT)	
AE	Equipment Teardown Time	Equipment teardown time in minutes.	

TABLE D-II. Descriptions and formats of land symbol amplifiers - Continued.

FIELD	FIELD TITLE	DESCRIPTION	FORMAT
AF	Common Identifier	Example: "Hawk" for Hawk SAM system.	
AL	Operational Condition	A graphic amplifier for equipment or installations that indicates operational condition or capacity.	Operational Condition amplifier, if used, shall be comprised of only one color. Ex. Aircraft: Red - damaged, Green – fully capable Ex: Missile: Red – imminent threat, Green – no threat
AO	Engagement Bar	A graphic amplifier placed immediately atop the symbol. May denote, 1) local/remote status; 2) engagement status; and 3) weapon type.	A:BBC-CC, where A = remote/local BBB = engagement status CC = weapon asset
AR	Special Designator	Special track designators such as Non-Real Time (NRT) and Tactically Significant (SIG) tracks are denoted here	

Notes: 1. Field J: See TC 2-33.4.
2. Field W: D = day, H = hour, M = minute, S = second, Z = Greenwich or local time, MON= month and Y = year.

D.5.3.3.2 Graphic amplifiers. Graphic amplifiers can be static, located in a fixed position in relation to a track’s symbol, or dynamic and move about the symbol based on the track’s characteristics. [See 5.1.6](#) for more information on amplifiers, including examples of dynamic amplifiers.

D.5.3.3.2.1 Headquarters staff amplifier. The headquarters staff amplifier is a line extending downward from the left side of the frame that identifies units, equipment and installations as headquarters. The headquarters staff amplifier shall extend a distance of one octagon height below the bottom of the frame. [See figure D-4.](#)

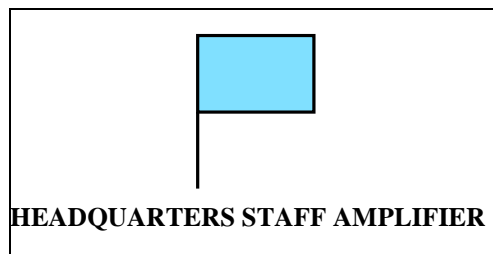

FIGURE D-4. Headquarters staff amplifier.

D.5.3.3.2.2 Echelon amplifier. The echelon amplifier provides a graphic representation of command level and a separate echelon known as Command, as shown in [table D-III](#).

TABLE D-III. Echelon amplifiers.

AMPLIFIER	DESCRIPTION
∅	TEAM/CREW
•	SQUAD
••	SECTION
•••	PLATOON/DETACHMENT
I	COMPANY/BATTERY/TROOP
II	BATTALION/SQUADRON
III	REGIMENT/GROUP
X	BRIGADE
X X	DIVISION
X X X	CORPS
X X X X	ARMY
X X X X X	ARMY GROUP
X X X X X X	THEATER
+	COMMAND ¹

Notes: 1. Command is a unit or units, an organization, or an area under the command of one individual. It does not correspond to any of the other echelons.

D.6 LAND UNIT SYMBOLS

D.6.1 Land unit symbols. This section includes the lists of icons and modifiers for building land unit symbols.

D.6.2 Land unit icons. [Table D-IV](#) depicts land unit icons. The information in grey is provided for orientation only and is not part of the icon.

TABLE D-IV. Land unit icons.

DESCRIPTION	ICON	REMARKS
COMMAND AND CONTROL Type: Entity Symbol Set Code: 10 Code: 110000 Icon Type: Main		This symbol shall not be displayed on a C2 system but may be displayed for training or hierarchal explanation purposes.

TABLE D-IV. Land unit icons - Continued.





DESCRIPTION	ICON	REMARKS
BROADCAST TRANSMITTER ANTENNAE Type: Entity Type Entity: COMMAND AND CONTROL Symbol Set Code: 10 Code: 110100 Icon Type: Full Octagon		N/A
CIVIL AFFAIRS Type: Entity Type Entity: COMMAND AND CONTROL Symbol Set Code: 10 Code: 110200 Icon Type: Main		N/A
CIVIL-MILITARY COOPERATION Type: Entity Type Entity: COMMAND AND CONTROL Symbol Set Code: 10 Code: 110300 Icon Type: Main		N/A
INFORMATION OPERATIONS Type: Entity Type Entity: COMMAND AND CONTROL Symbol Set Code: 10 Code: 110400 Icon Type: Main		N/A
LIAISON Type: Entity Type Entity: COMMAND AND CONTROL Symbol Set Code: 10 Code: 110500 Icon Type: Main		N/A
MILITARY INFORMATION SUPPORT OPERATIONS (MISO) Type: Entity Type Entity: COMMAND AND CONTROL Symbol Set Code: 10 Code: 110600 Icon Type: Main		N/A

TABLE D-IV. Land unit icons - Continued.

DESCRIPTION	ICON	REMARKS
<p>BROADCAST TRANSMITTER ANTENNAE</p> <p>Type: Entity Subtype Entity/Entity Type: COMMAND AND CONTROL/MILITARY INFORMATION SUPPORT OPERATIONS (MISO)</p> <p>Symbol Set Code: 10 Code: 110601 Icon Type: Full Octagon</p>		<p>N/A</p>
<p>RADIO</p> <p>Type: Entity Type Entity/Entity Type: COMMAND AND CONTROL</p> <p>Symbol Set Code: 10 Code: 110700 Icon Type: Main</p>		<p>SIGNAL – RADIO</p>  <p>Code:111001</p>
<p>RADIO RELAY</p> <p>Type: Entity Type Entity/Entity Type: COMMAND AND CONTROL</p> <p>Symbol Set Code: 10 Code: 110800 Icon Type: Main</p>		<p>SIGNAL – RADIO RELAY</p>  <p>Code:111002</p>
<p>RADIO TELETYPE CENTER</p> <p>Type: Entity Type Entity/Entity Type: COMMAND AND CONTROL</p> <p>Symbol Set Code: 10 Code: 110900 Icon Type: Main</p>		<p>SIGNAL – TELETYPE</p>  <p>Code:111003</p>
<p>SIGNAL</p> <p>Type: Entity Type Entity: COMMAND AND CONTROL</p> <p>Symbol Set Code: 10 Code: 111000 Icon Type: Full Frame</p>		<p>N/A</p>

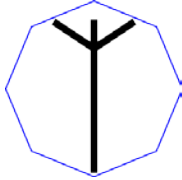
TABLE D-IV. Land unit icons - Continued.

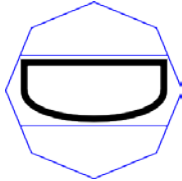
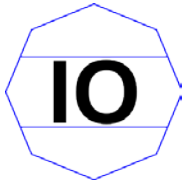
DESCRIPTION	ICON	REMARKS
<p>TACTICAL SATELLITE</p> <p>Type: Entity Type Entity: COMMAND AND CONTROL Symbol Set Code: 10 Code: 111100 Icon Type: Main</p>		<p>SIGNAL - TACTICAL SATELLITE</p>  <p>Code:111004</p>
<p>VIDEO IMAGERY (COMBAT CAMERA)</p> <p>Type: Entity Type Entity: COMMAND AND CONTROL Symbol Set Code: 10 Code: 111200 Icon Type: Main</p>		<p>SIGNAL - VIDEO IMAGERY (COMBAT CAMERA)</p>  <p>Code:111005</p>
<p>MOVEMENT AND MANEUVER</p> <p>Type: Entity Symbol Set Code: 10 Code: 120000 Icon Type: Main</p>	<p>N/A</p>	<p>No icon is associated with this entity. It is for hierarchal purposes only.</p>
<p>AIR ASSAULT WITH ORGANIC LIFT</p> <p>Type: Entity Type Entity: MOVEMENT AND MANEUVER Symbol Set Code: 10 Code: 120100 Icon Type: Full Frame</p>		<p>The grey box is not to be drawn. It is shown here only as a reference to position and proportion of the icon within the frame.</p>
<p>AIR TRAFFIC SERVICES/AIRFIELD OPERATIONS</p> <p>Type: Entity Type Entity: MOVEMENT AND MANEUVER Symbol Set Code: 10 Code: 120200 Icon Type: Main</p>		<p>N/A</p>

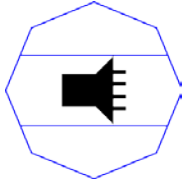
TABLE D-IV. Land unit icons - Continued.

DESCRIPTION	ICON	REMARKS
<p>AMPHIBIOUS</p> <p>Type: Entity Type Entity: MOVEMENT AND MANEUVER Symbol Set Code: 10 Code: 120300 Icon Type: Full Frame</p>		<p>The grey box is not to be drawn. It is shown here only as a reference to position and proportion of the icon within the frame.</p>
<p>ANTITANK/ANTIARMOR</p> <p>Type: Entity Type Entity: MOVEMENT AND MANEUVER Symbol Set Code: 10 Code: 120400 Icon Type: Full Frame</p>		<p>The grey box is not to be drawn. It is shown here only as a reference to position and proportion of the icon within the frame.</p>
<p>ARMORED</p> <p>Type: Entity Type Entity: MOVEMENT AND MANEUVER/ AINTITANK/ANTIARMOR Symbol Set Code: 10 Code: 120401 Icon Type: Full Frame</p>		<p>The grey box is not to be drawn. It is shown here only as a reference to position and proportion of the icon within the frame.</p>
<p>MOTORIZED</p> <p>Type: Entity Type Entity: MOVEMENT AND MANEUVER/ AINTITANK/ANTIARMOR Symbol Set Code: 10 Code: 120402 Icon Type: Full Frame</p>		<p>The grey box is not to be drawn. It is shown here only as a reference to position and proportion of the icon within the frame.</p>
<p>ARMOR/ARMORED/ MECHANIZED/SELF-PROPELLED/TRACKED</p> <p>Type: Entity Type Entity: MOVEMENT AND MANEUVER Symbol Set Code: 10 Code: 120500 Icon Type: Main</p>		<p>N/A</p>

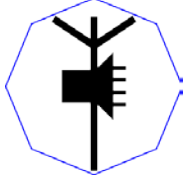
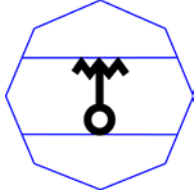
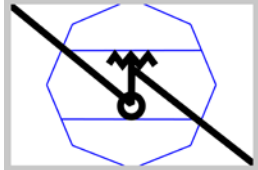
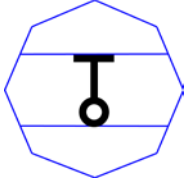
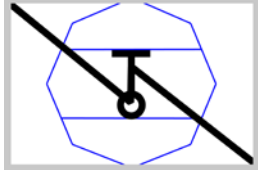
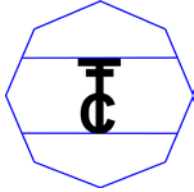
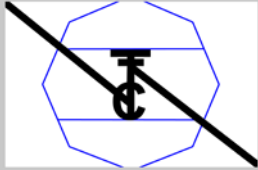
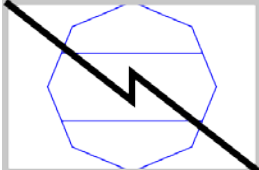
TABLE D-IV. Land unit icons - Continued.

DESCRIPTION	ICON	REMARKS
<p>RECONNAISSANCE/CAVALRY/SCOUT</p> <p>Type: Entity Type Entity: MOVEMENT AND MANEUVER/ARMOR/ARMORED/MECHANIZED/SELF-PROPELLED/TRACKED Symbol Set Code: 10 Code: 120501 Icon Type: Full Frame</p>		<p>The grey box is not to be drawn. It is shown here only as a reference to position and proportion of the icon within the frame.</p>
<p>AMPHIBIOUS</p> <p>Type: Entity Type Entity: MOVEMENT AND MANEUVER/ARMOR/ARMORED/MECHANIZED/SELF-PROPELLED/TRACKED Symbol Set Code: 10 Code: 120502 Icon Type: Full Frame</p>		<p>The grey box is not to be drawn. It is shown here only as a reference to position and proportion of the icon within the frame.</p>
<p>ARMY AVIATION/AVIATION ROTARY WING</p> <p>Type: Entity Type Entity: MOVEMENT AND MANEUVER Symbol Set Code: 10 Code: 120600 Icon Type: Main</p>		<p>N/A</p>
<p>RECONNAISSANCE</p> <p>Type: Entity Type Entity: MOVEMENT AND MANEUVER/ ARMY AVIATION/AVIATION ROTARY WING Symbol Set Code: 10 Code: 120601 Icon Type: Full Frame</p>		<p>The grey box is not to be drawn. It is shown here only as a reference to position and proportion of the icon within the frame.</p>
<p>AVIATION COMPOSITE</p> <p>Type: Entity Type Entity: MOVEMENT AND MANEUVER Symbol Set Code: 10 Code: 120700 Icon Type: Main</p>		<p>N/A</p>

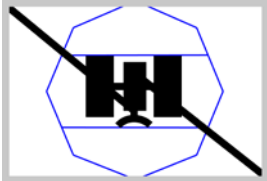
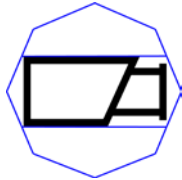
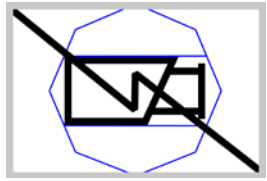
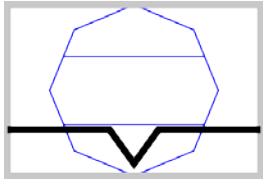
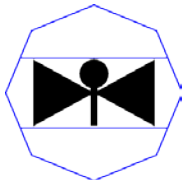
TABLE D-IV. Land unit icons - Continued.

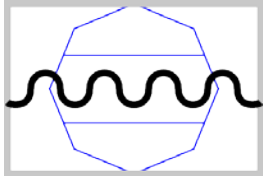
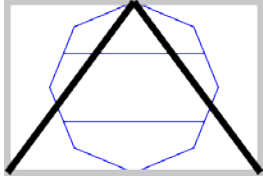
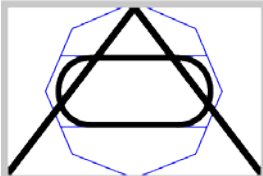
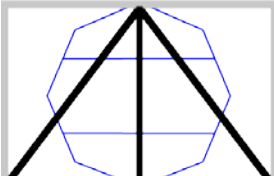
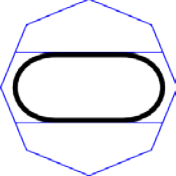

DESCRIPTION	ICON	REMARKS
<p>AVIATION FIXED WING</p> <p>Type: Entity Type Entity: MOVEMENT AND MANEUVER Symbol Set Code: 10 Code: 120800 Icon Type: Main</p>		<p>N/A</p>
<p>RECONNAISSANCE</p> <p>Type: Entity Type Entity: MOVEMENT AND MANEUVER/ ARMY AVIATION/AVIATION FIXED WING Symbol Set Code: 10 Code: 120801 Icon Type: Full Frame</p>		<p>The grey box is not to be drawn. It is shown here only as a reference to position and proportion of the icon within the frame.</p>
<p>COMBAT</p> <p>Type: Entity Type Entity: MOVEMENT AND MANEUVER Symbol Set Code: 10 Code: 120900 Icon Type: Main</p>		<p>N/A</p>
<p>COMBINED ARMS</p> <p>Type: Entity Type Entity: MOVEMENT AND MANEUVER Symbol Set Code: 10 Code: 121000 Icon Type: Main</p>		<p>N/A</p>
<p>INFANTRY</p> <p>Type: Entity Type Entity: MOVEMENT AND MANEUVER Symbol Set Code: 10 Code: 121100 Icon Type: Full Frame</p>		<p>The grey box is not to be drawn. It is shown here only as a reference to position and proportion of the icon within the frame.</p>
<p>AMPHIBIOUS</p> <p>Type: Entity Subtype Entity/Entity Type: MOVEMENT AND MANEUVER/INFANTRY Symbol Set Code: 10 Code: 121101 Icon Type: Full Frame</p>		<p>The grey box is not to be drawn. It is shown here only as a reference to position and proportion of the icon within the frame.</p>

TABLE D-IV. Land unit icons - Continued.

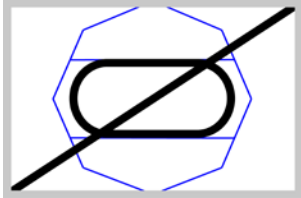
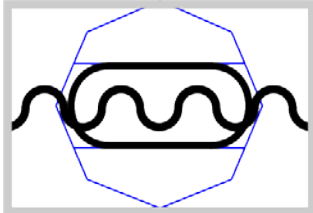
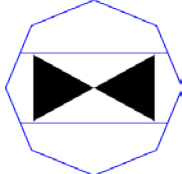
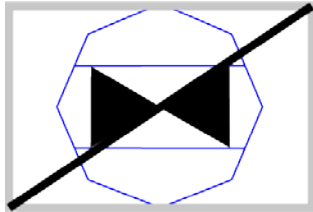
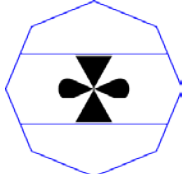
DESCRIPTION	ICON	REMARKS
<p>ARMORED/MECHANIZED/TRACKED</p> <p>Type: Entity Subtype Entity/Entity Type: MOVEMENT AND MANEUVER/INFANTRY Symbol Set Code: 10 Code: 121102 Icon Type: Main</p>		<p>The grey box is not to be drawn. It is shown here only as a reference to position and proportion of the icon within the frame.</p>
<p>MAIN GUN SYSTEM</p> <p>Type: Entity Subtype Entity/Entity Type: MOVEMENT AND MANEUVER/INFANTRY Symbol Set Code: 10 Code: 121103 Icon Type: Full Frame</p>		<p>The grey box is not to be drawn. It is shown here only as a reference to position and proportion of the icon within the frame.</p>
<p>MOTORIZED</p> <p>Type: Entity Subtype Entity/Entity Type: MOVEMENT AND MANEUVER/INFANTRY Symbol Set Code: 10 Code: 121104 Icon Type: Full Frame</p>		<p>The grey box is not to be drawn. It is shown here only as a reference to position and proportion of the icon within the frame.</p>
<p>INFANTRY FIGHTING VEHICLE</p> <p>Type: Entity Subtype Entity/Entity Type: MOVEMENT AND MANEUVER/INFANTRY Symbol Set Code: 10 Code: 121105 Icon Type: Full Frame</p>		<p>The grey box is not to be drawn. It is shown here only as a reference to position and proportion of the icon within the frame.</p>
<p>OBSERVER</p> <p>Type: Entity Type Entity: MOVEMENT AND MANEUVER Symbol Set Code: 10 Code: 121200 Icon Type: Main</p>		<p>N/A</p>
<p>RECONNAISSANCE/CAVALRY/SCOUT</p> <p>Type: Entity Type Entity: MOVEMENT AND MANEUVER Symbol Set Code: 10 Code: 121300 Icon Type: Full Frame</p>		<p>The grey box is not to be drawn. It is shown here only as a reference to position and proportion of the icon within the frame.</p>

TABLE D-IV. Land unit icons - Continued.

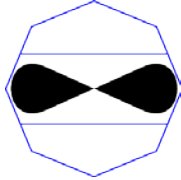
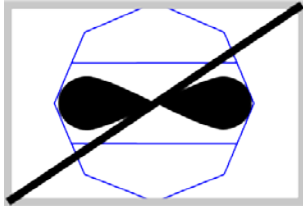

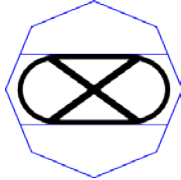
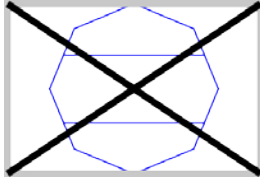
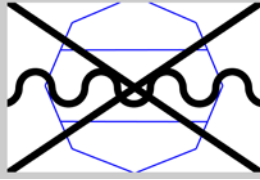
DESCRIPTION	ICON	REMARKS
<p>RECONNAISSANCE AND SURVEILLANCE</p> <p>Type: Entity Type Entity: MOVEMENT AND MANEUVER/RECONNAISSANCE/CAVALRY/SCOUT Symbol Set Code: 10 Code: 121301 Icon Type: Full Frame</p>		<p>The grey box is not to be drawn. It is shown here only as a reference to position and proportion of the icon within the frame.</p>
<p>MARINE</p> <p>Type: Entity Type Entity: MOVEMENT AND MANEUVER/RECONNAISSANCE/CAVALRY/SCOUT Symbol Set Code: 10 Code: 121302 Icon Type: Full Frame</p>		<p>The grey box is not to be drawn. It is shown here only as a reference to position and proportion of the icon within the frame.</p>
<p>MOTORIZED</p> <p>Type: Entity Type Entity: MOVEMENT AND MANEUVER/RECONNAISSANCE/CAVALRY/SCOUT Symbol Set Code: 10 Code: 121303 Icon Type: Full Frame</p>		<p>The grey box is not to be drawn. It is shown here only as a reference to position and proportion of the icon within the frame.</p>
<p>SEA AIR LAND (SEAL)</p> <p>Type: Entity Type Entity: MOVEMENT AND MANEUVER Symbol Set Code: 10 Code: 121400 Icon Type: Main</p>		<p>N/A</p>
<p>SNIPER</p> <p>Type: Entity Type Entity: MOVEMENT AND MANEUVER Symbol Set Code: 10 Code: 121500 Icon Type: Main</p>		<p>N/A</p>

TABLE D-IV. Land unit icons - Continued.

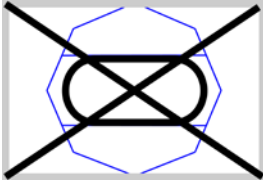
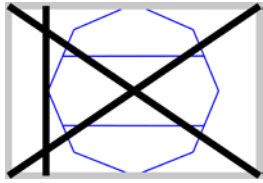
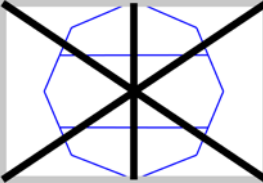
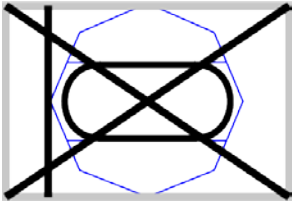
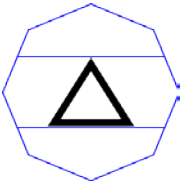
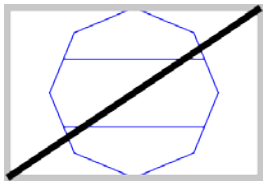

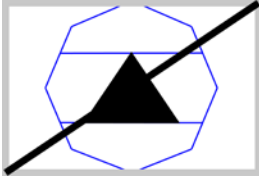
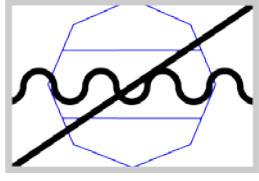
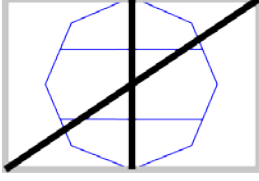

DESCRIPTION	ICON	REMARKS
<p>SURVEILLANCE</p> <p>Type: Entity Type Entity: MOVEMENT AND MANEUVER Symbol Set Code: 10 Code: 121600 Icon Type: Main</p>		<p>N/A</p>
<p>SPECIAL FORCES</p> <p>Type: Entity Type Entity: MOVEMENT AND MANEUVER Symbol Set Code: 10 Code: 121700 Icon Type: Main</p>		<p>N/A</p>
<p>SPECIAL OPERATIONS FORCES (SOF)</p> <p>Type: Entity Type Entity: MOVEMENT AND MANEUVER Symbol Set Code: 10 Code: 121800 Icon Type: Main</p>		<p>N/A</p>
<p>FIXED WING MISO</p> <p>Type: Entity Subtype Entity: MOVEMENT AND MANEUVER/SPECIAL OPERATIONS FORCES (SOF) Symbol Set Code: 10 Code: 121801 Icon Type: Full Octagon</p>		<p>N/A</p>
<p>GROUND</p> <p>Type: Entity Subtype Entity: MOVEMENT AND MANEUVER/SPECIAL OPERATIONS FORCES (SOF) Symbol Set Code: 10 Code: 121802 Icon Type: Full Frame</p>		<p>N/A</p>

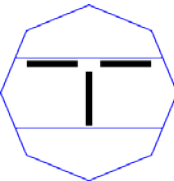
TABLE D-IV. Land unit icons - Continued.

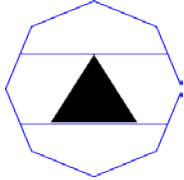

DESCRIPTION	ICON	REMARKS
<p>SPECIAL BOAT</p> <p>Type: Entity Subtype Entity: MOVEMENT AND MANEUVER/SPECIAL OPERATIONS FORCES (SOF) Symbol Set Code: 10 Code: 121803 Icon Type: Main +1</p>		<p>N/A</p>
<p>SPECIAL SSNR</p> <p>Type: Entity Subtype Entity: MOVEMENT AND MANEUVER/SPECIAL OPERATIONS FORCES (SOF) Symbol Set Code: 10 Code: 121804 Icon Type: Main +1</p>		<p>N/A</p>
<p>UNDERWATER DEMOLITIONS TEAM</p> <p>Type: Entity Subtype Entity: MOVEMENT AND MANEUVER/SPECIAL OPERATIONS FORCES (SOF) Symbol Set Code: 10 Code: 121805 Icon Type: Main</p>		<p>N/A</p>
<p>UNMANNED AERIAL SYSTEMS</p> <p>Type: Entity Type Entity: MOVEMENT AND MANEUVER Symbol Set Code: 10 Code: 121900 Icon Type: Main</p>		<p>N/A</p>
<p>FIRES</p> <p>Type: Entity Symbol Set Code: 10 Code: 130000</p>	<p>N/A</p>	<p>No icon is associated with this entity. It is for hierarchal purposes only.</p>
<p>AIR DEFENSE</p> <p>Type: Entity Type Entity: FIRES Symbol Set Code: 10 Code: 130100 Icon Type: Full Frame</p>		<p>The grey box is not to be drawn. It is shown here only as a reference to position and proportion of the icon within the frame.</p>

TABLE D-IV. Land unit icons - Continued.

DESCRIPTION	ICON	REMARKS
<p>MAIN GUN SYSTEM</p> <p>Type: Entity Type Entity: FIRES/AIR DEFENSE Symbol Set Code: 10 Code: 130101 Icon Type: Full Frame</p>		<p>The grey box is not to be drawn. It is shown here only as a reference to position and proportion of the icon within the frame.</p>
<p>MISSILE</p> <p>Type: Entity Type Entity: FIRES/AIR DEFENSE Symbol Set Code: 10 Code: 130102 Icon Type: Full Frame</p>		<p>The grey box is not to be drawn. It is shown here only as a reference to position and proportion of the icon within the frame.</p>
<p>AIR/LAND NAVAL GUNFIRE LIAISON</p> <p>Type: Entity Type Entity: FIRES Symbol Set Code: 10 Code: 130200 Icon Type: Full Frame</p>		<p>The grey box is not to be drawn. It is shown here only as a reference to position and proportion of the icon within the frame.</p>
<p>FIELD ARTILLERY</p> <p>Type: Entity Type Entity: FIRES Symbol Set Code: 10 Code: 130300 Icon Type: Main</p>		<p>N/A</p>
<p>SELF-PROPELLED</p> <p>Type: Entity Type Entity: FIRES/FIELD ARTILLERY Symbol Set Code: 10 Code: 130301 Icon Type: Main</p>		<p>N/A</p>
<p>TARGET ACQUISITION</p> <p>Type: Entity Type Entity: FIRES/FIELD ARTILLERY Symbol Set Code: 10 Code: 130302 Icon Type: Full Frame</p>		<p>N/A</p>
<p>FIELD ARTILLERY OBSERVER</p> <p>Type: Entity Type Entity: FIRES Symbol Set Code: 10 Code: 130400 Icon Type: Main</p>		<p>N/A</p>

TABLE D-IV. Land unit icons - Continued.

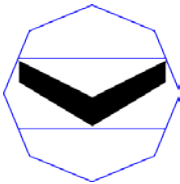
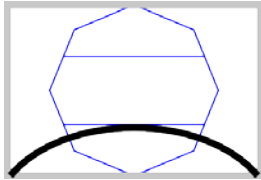

DESCRIPTION	ICON	REMARKS
<p>JOINT FIRE SUPPORT</p> <p>Type: Entity Type Entity: FIRES Symbol Set Code: 10 Code: 130500 Icon Type: Main</p>		<p>N/A</p>
<p>METEOROLOGICAL</p> <p>Type: Entity Type Entity: FIRES Symbol Set Code: 10 Code: 130600 Icon Type: Main</p>		<p>N/A</p>
<p>MISSILE</p> <p>Type: Entity Type Entity: FIRES Symbol Set Code: 10 Code: 130700 Icon Type: Main</p>		<p>N/A</p>
<p>MORTAR</p> <p>Type: Entity Type Entity: FIRES Symbol Set Code: 10 Code: 130800 Icon Type: Main</p>		<p>N/A</p>
<p>ARMORED/MECHANIZED/ TRACKED</p> <p>Type: Entity Subtype Entity/Entity Type: FIRES/MORTAR Symbol Set Code: 10 Code: 130801 Icon Type: Full Octagon</p>		<p>N/A</p>
<p>SELF-PROPELLED WHEELED</p> <p>Type: Entity Subtype Entity/Entity Type: FIRES/MORTAR Symbol Set Code: 10 Code: 130802 Icon Type: Full Octagon</p>		<p>N/A</p>

TABLE D-IV. Land unit icons - Continued.

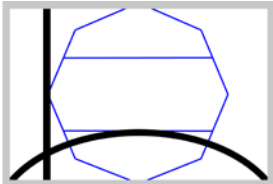
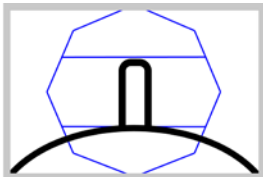
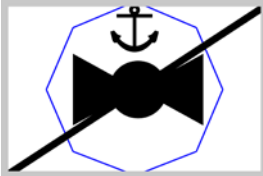
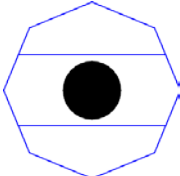
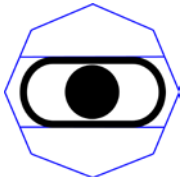
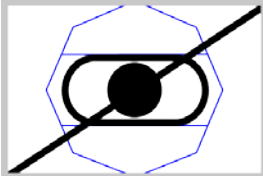
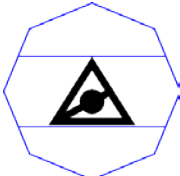
DESCRIPTION	ICON	REMARKS
<p>TOWED</p> <p>Type: Entity Subtype Entity/Entity Type: FIRES/MORTAR Symbol Set Code: 10 Code: 130803 Icon Type: Full Octagon</p>		<p>N/A</p>
<p>SURVEY</p> <p>Type: Entity Type Entity: FIRES Symbol Set Code: 10 Code: 130900 Icon Type: Main</p>		<p>N/A</p>
<p>PROTECTION</p> <p>Type: Entity Symbol Set Code: 10 Code: 140000</p>	<p>N/A</p>	<p>No icon is associated with this entity. It is for hierarchal purposes only.</p>
<p>CHEMICAL BIOLOGICAL RADIOLOGICAL NUCLEAR DEFENSE</p> <p>Type: Entity Type Entity: PROTECTION Symbol Set Code: 10 Code: 140100 Icon Type: Main</p>		<p>N/A</p>
<p>MECHANIZED</p> <p>Type: Entity Subtype Entity: PROTECTION/CHEMICAL BIOLOGICAL RADIOLOGICAL NUCLEAR DEFENSE Symbol Set Code: 10 Code: 140101 Icon Type: Main</p>		
<p>MOTORIZED</p> <p>Type: Entity Subtype Entity: PROTECTION/CHEMICAL BIOLOGICAL RADIOLOGICAL NUCLEAR DEFENSE Symbol Set Code: 10 Code: 140102 Icon Type: Full Octagon</p>		

TABLE D-IV. Land unit icons - Continued.

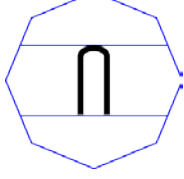
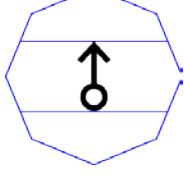
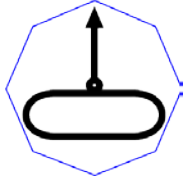
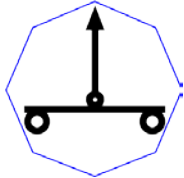

DESCRIPTION	ICON	REMARKS
<p>RECONNAISSANCE</p> <p>Type: Entity Subtype Entity: PROTECTION/CHEMICAL BIOLOGICAL RADIOLOGICAL NUCLEAR DEFENSE Symbol Set Code: 10 Code: 140103 Icon Type: Full Frame</p>		<p>The grey box is not to be drawn. It is shown here only as a reference to position and proportion of the icon within the frame.</p>
<p>RECONNAISSANCE ARMORED</p> <p>Type: Entity Subtype Entity: PROTECTION/CHEMICAL BIOLOGICAL RADIOLOGICAL NUCLEAR DEFENSE Symbol Set Code: 10 Code: 140104 Icon Type: Full Frame</p>		<p>The grey box is not to be drawn. It is shown here only as a reference to position and proportion of the icon within the frame.</p>
<p>RECONNAISSANCE EQUIPED</p> <p>Type: Entity Subtype Entity: PROTECTION/CHEMICAL BIOLOGICAL RADIOLOGICAL NUCLEAR DEFENSE Symbol Set Code: 10 Code: 140105 Icon Type: Full Frame</p>		<p>The grey box is not to be drawn. It is shown here only as a reference to position and proportion of the icon within the frame.</p>
<p>COMBAT SUPPORT (MANEUVER ENHANCEMENT)</p> <p>Type: Entity Type Entity: PROTECTION Symbol Set Code: 10 Code: 140200 Icon Type: Main</p>		<p>N/A</p>
<p>CRIMINAL INVESTIGATION DIVISION</p> <p>Type: Entity Type Entity: PROTECTION Symbol Set Code: 10 Code: 140300 Icon Type: Main</p>		<p>N/A</p>

TABLE D-IV. Land unit icons - Continued.

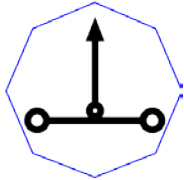
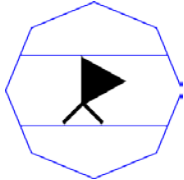
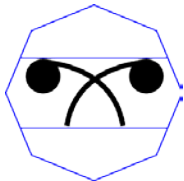
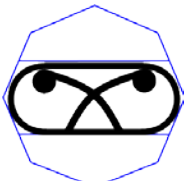
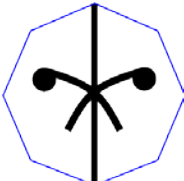

DESCRIPTION	ICON	REMARKS
<p>DIVING</p> <p>Type: Entity Type Entity: PROTECTION Symbol Set Code: 10 Code: 140400 Icon Type: Main</p>		<p>N/A</p>
<p>DOG</p> <p>Type: Entity Type Entity: PROTECTION Symbol Set Code: 10 Code: 140500 Icon Type: Main</p>		<p>N/A</p>
<p>DRILLING</p> <p>Type: Entity Type Entity: PROTECTION Symbol Set Code: 10 Code: 140600 Icon Type: Main</p>		<p>N/A</p>
<p>ENGINEER</p> <p>Type: Entity Type Entity: PROTECTION Symbol Set Code: 10 Code: 140700 Icon Type: Main</p>		<p>N/A</p>
<p>MECHANIZED</p> <p>Type: Entity Subtype Entity: PROTECTION/ENGINEER Symbol Set Code: 10 Code: 140701 Icon Type: Main</p>		
<p>MOTORIZED</p> <p>Type: Entity Subtype Entity: PROTECTION/ENGINEER Symbol Set Code: 10 Code: 140702 Icon Type: Full Octagon</p>		

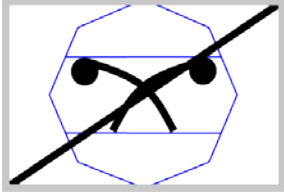
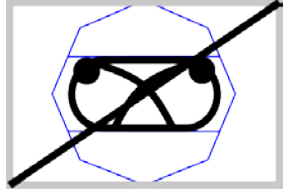
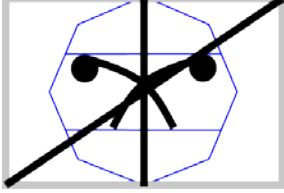
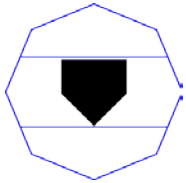
TABLE D-IV. Land unit icons - Continued.



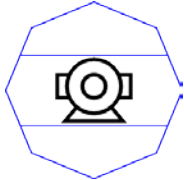

DESCRIPTION	ICON	REMARKS
<p>RECONNAISSANCE</p> <p>Type: Entity Subtype Entity: PROTECTION/ENGINEER Symbol Set Code: 10 Code: 140703 Icon Type: Full Frame</p>		<p>The grey box is not to be drawn. It is shown here only as a reference to position and proportion of the icon within the frame.</p>
<p>EXPLOSIVE ORDNANCE DISPOSAL (EOD)</p> <p>Type: Entity Type Entity: PROTECTION Symbol Set Code: 10 Code: 140800 Icon Type: Main</p>		<p>N/A</p>
<p>FIELD CAMP CONSTRUCTION</p> <p>Type: Entity Type Entity: PROTECTION Symbol Set Code: 10 Code: 140900 Icon Type: Main+1</p>		<p>N/A</p>
<p>FIRE FIGHTING/FIRE PROTECTION</p> <p>Type: Entity Type Entity: PROTECTION Symbol Set Code: 10 Code: 141000 Icon Type: Main</p>		<p>N/A</p>
<p>GEOSPATIAL SUPPORT/GEOSPATIAL INFORMATION SUPPORT</p> <p>Type: Entity Type Entity: PROTECTION Symbol Set Code: 10 Code: 141100 Icon Type: Main</p>		<p>N/A</p>
<p>MILITARY POLICE</p> <p>Type: Entity Type Entity: PROTECTION Symbol Set Code: 10 Code: 141200 Icon Type: Main</p>		<p>N/A</p>

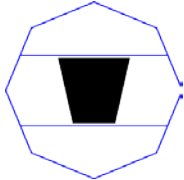
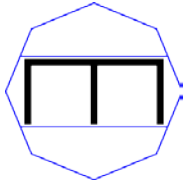
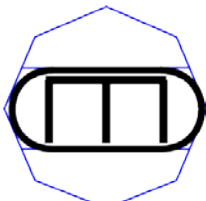
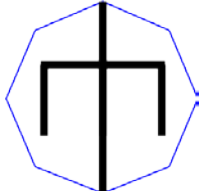
TABLE D-IV. Land unit icons - Continued.



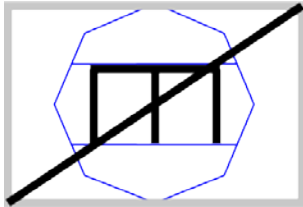

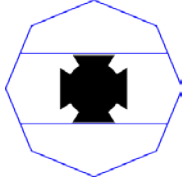
DESCRIPTION	ICON	REMARKS
<p>MINE</p> <p>Type: Entity Type Entity: PROTECTION Symbol Set Code: 10 Code: 141300 Icon Type: Main</p>		<p>N/A</p>
<p>MINE CLEARING</p> <p>Type: Entity Type Entity: PROTECTION Symbol Set Code: 10 Code: 141400 Icon Type: Full Octagon</p>		<p>N/A</p>
<p>MINE LAUNCHING</p> <p>Type: Entity Type Entity: PROTECTION Symbol Set Code: 10 Code: 141500 Icon Type: Full Octagon</p>		<p>N/A</p>
<p>MINE LAYING</p> <p>Type: Entity Type Entity: PROTECTION Symbol Set Code: 10 Code: 141600 Icon Type: Full Octagon</p>		<p>N/A</p>
<p>SECURITY</p> <p>Type: Entity Type Entity: PROTECTION Symbol Set Code: 10 Code: 141700 Icon Type: Main</p>		<p>N/A</p>
<p>MECHANIZED</p> <p>Type: Entity Type Entity: PROTECTION/SECURITY Symbol Set Code: 10 Code: 141701 Icon Type: Main</p>		

TABLE D-IV. Land unit icons - Continued.



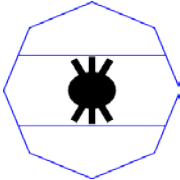

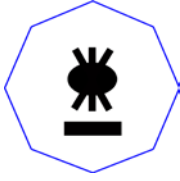
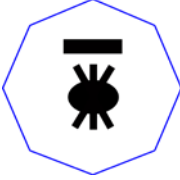
DESCRIPTION	ICON	REMARKS
MOTORIZED Type: Entity Type Entity: PROTECTION/SECURITY Symbol Set Code: 10 Code: 141702 Icon Type: Main		
SEARCH AND RESCUE Type: Entity Type Entity: PROTECTION Symbol Set Code: 10 Code: 141800 Icon Type: Main		N/A
SECURITY POLICE (AIR) Type: Entity Type Entity: PROTECTION Symbol Set Code: 10 Code: 141900 Icon Type: Main+2		N/A
SHORE PATROL Type: Entity Type Entity: PROTECTION Symbol Set Code: 10 Code: 142000 Icon Type: Main		N/A
TOPOGRAPHIC Type: Entity Type Entity: PROTECTION Symbol Set Code: 10 Code: 142100 Icon Type: Main		N/A
INTELLIGENCE Type: Entity Symbol Set Code: 10 Code: 150000	N/A	No icon is associated with this entity. It is for hierarchal purposes only.
ANALYSIS Type: Entity Type Entity: INTELLIGENCE Symbol Set Code: 10 Code: 150100 Icon Type: Full Octagon		N/A

TABLE D-IV. Land unit icons - Continued.



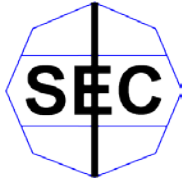

DESCRIPTION	ICON	REMARKS
<p>COUNTERINTELLIGENCE</p> <p>Type: Entity Type Entity: INTELLIGENCE Symbol Set Code: 10 Code: 150200 Icon Type: Main</p>		<p>N/A</p>
<p>DIRECTION FINDING</p> <p>Type: Entity Type Entity: INTELLIGENCE Symbol Set Code: 10 Code: 150300 Icon Type: Full Octagon</p>		<p>N/A</p>
<p>ELECTRONIC RANGING</p> <p>Type: Entity Type Entity: INTELLIGENCE Symbol Set Code: 10 Code: 150400 Icon Type: Main</p>		<p>N/A</p>
<p>ELECTRONIC WARFARE</p> <p>Type: Entity Type Entity: INTELLIGENCE Symbol Set Code: 10 Code: 150500 Icon Type: Main</p>		<p>N/A</p>
<p>ANALYSIS</p> <p>Type: Entity Subtype Entity/Entity Type: INTELLIGENCE/ELECTRONIC WARFARE Symbol Set Code: 10 Code: 150501 Icon Type: Full Octagon</p>		<p>N/A</p>
<p>DIRECTION FINDING</p> <p>Type: Entity Subtype Entity/Entity Type: INTELLIGENCE/ELECTRONIC WARFARE Symbol Set Code: 10 Code: 150502 Icon Type: Full Octagon</p>		<p>N/A</p>

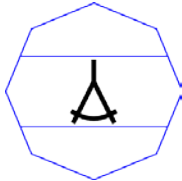
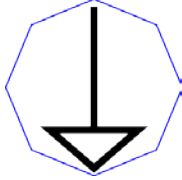
TABLE D-IV. Land unit icons - Continued.



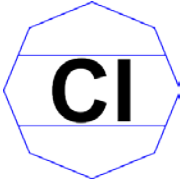
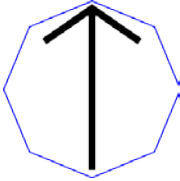
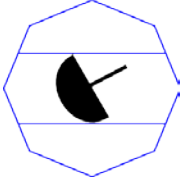

DESCRIPTION	ICON	REMARKS
<p>INTERCEPT</p> <p>Type: Entity Subtype Entity/Entity Type: INTELLIGENCE/ELECTRONIC WARFARE Symbol Set Code: 10 Code: 150503 Icon Type: Full Octagon</p>		<p>N/A</p>
<p>JAMMING</p> <p>Type: Entity Subtype Entity/Entity Type: INTELLIGENCE/ELECTRONIC WARFARE Symbol Set Code: 10 Code: 150504 Icon Type: Full Frame</p>		<p>The grey box is not to be drawn. It is shown here only as a reference to position and proportion of the icon within the frame.</p>
<p>SEARCH</p> <p>Type: Entity Subtype Entity/Entity Type: INTELLIGENCE/ELECTRONIC WARFARE Symbol Set Code: 10 Code: 150505 Icon Type: Full Octagon</p>		<p>N/A</p>
<p>INTERCEPT (SEARCH AND RECORDING)</p> <p>Type: Entity Type Entity: INTELLIGENCE Symbol Set Code: 10 Code: 150600 Icon Type: Full Octagon</p>		<p>N/A</p>
<p>INTERROGATION</p> <p>Type: Entity Type Entity: INTELLIGENCE Symbol Set Code: 10 Code: 150700 Icon Type: Main</p>		<p>N/A</p>
<p>JAMMING</p> <p>Type: Entity Type Entity: INTELLIGENCE Symbol Set Code: 10 Code: 150800 Icon Type: Full Frame</p>		<p>The grey box is not to be drawn. It is shown here only as a reference to position and proportion of the icon within the frame.</p>

TABLE D-IV. Land unit icons - Continued.

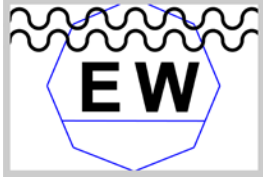

DESCRIPTION	ICON	REMARKS
<p>JOINT INTELLIGENCE CENTER</p> <p>Type: Entity Type Entity: INTELLIGENCE Symbol Set Code: 10 Code: 150900 Icon Type: Main</p>		<p>N/A</p>
<p>MILITARY INTELLIGENCE</p> <p>Type: Entity Type Entity: INTELLIGENCE Symbol Set Code: 10 Code: 151000 Icon Type: Main</p>		<p>N/A</p>
<p>SEARCH</p> <p>Type: Entity Type Entity: INTELLIGENCE Symbol Set Code: 10 Code: 151100 Icon Type: Full Octagon</p>		<p>N/A</p>
<p>SENSOR</p> <p>Type: Entity Type Entity: INTELLIGENCE Symbol Set Code: 10 Code: 151200 Icon Type: Main</p>		<p>N/A</p>
<p>SUSTAINMENT</p> <p>Type: Entity Symbol Set Code: 10 Code: 160000</p>		<p>N/A</p>
<p>ADMINISTRATIVE</p> <p>Type: Entity Type Entity: SUSTAINMENT Symbol Set Code: 10 Code: 160100 Icon Type: Main</p>		<p>N/A</p>
<p>ALL CLASSES OF SUPPLY</p> <p>Type: Entity Type Entity: SUSTAINMENT Symbol Set Code: 10 Code: 160200 Icon Type: Full Frame</p>		<p>The grey box is not to be drawn. It is shown here only as a reference to position and proportion of the icon within the frame.</p>

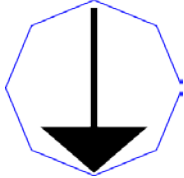
TABLE D-IV. Land unit icons - Continued.

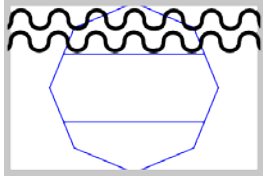

DESCRIPTION	ICON	REMARKS
AIRPORT OF DEBARKATION/AIRPORT OF EMBARKATION Type: Entity Type Entity: SUSTAINMENT Symbol Set Code: 10 Code: 160300 Icon Type: Main+1		N/A
AMMUNITION Type: Entity Type Entity: SUSTAINMENT Symbol Set Code: 10 Code: 160400 Icon Type: Main		N/A
BAND Type: Entity Type Entity: SUSTAINMENT Symbol Set Code: 10 Code: 160500 Icon Type: Main		N/A
COMBAT SERVICE SUPPORT Type: Entity Type Entity: SUSTAINMENT Symbol Set Code: 10 Code: 160600 Icon Type: Main		N/A
FINANCE Type: Entity Type Entity: SUSTAINMENT Symbol Set Code: 10 Code: 160700 Icon Type: Main		N/A
JUDGE ADVOCATE GENERAL Type: Entity Type Entity: SUSTAINMENT Symbol Set Code: 10 Code: 160800 Icon Type: Main		N/A
LABOR Type: Entity Type Entity: SUSTAINMENT Symbol Set Code: 10 Code: 160900 Icon Type: Main		N/A

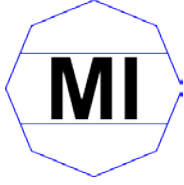
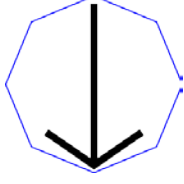
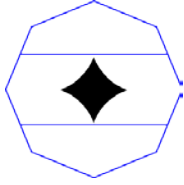
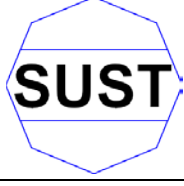
TABLE D-IV. Land unit icons - Continued.

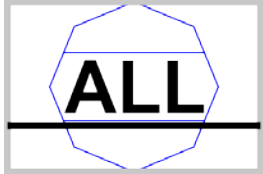

DESCRIPTION	ICON	REMARKS
<p>LAUNDRY/BATH</p> <p>Type: Entity Type Entity: SUSTAINMENT Symbol Set Code: 10 Code: 161000 Icon Type: Main</p>		<p>N/A</p>
<p>MAINTENANCE</p> <p>Type: Entity Type Entity: SUSTAINMENT Symbol Set Code: 10 Code: 161100 Icon Type: Main</p>		<p>N/A</p>
<p>MATERIAL</p> <p>Type: Entity Type Entity: SUSTAINMENT Symbol Set Code: 10 Code: 161200 Icon Type: Full Frame</p>		<p>The grey box is not to be drawn. It is shown here only as a reference to position and proportion of the icon within the frame.</p>
<p>MEDICAL</p> <p>Type: Entity Type Entity: SUSTAINMENT Symbol Set Code: 10 Code: 161300 Icon Type: Full Frame</p>		<p>The grey box is not to be drawn. It is shown here only as a reference to position and proportion of the icon within the frame.</p>
<p>MEDICAL TREATMENT FACILITY</p> <p>Type: Entity Type Entity: SUSTAINMENT Symbol Set Code: 10 Code: 161400 Icon Type: Full Frame</p>		<p>The grey box is not to be drawn. It is shown here only as a reference to position and proportion of the icon within the frame.</p>
<p>MORALE, WELFARE AND RECREATION</p> <p>Type: Entity Type Entity: SUSTAINMENT Symbol Set Code: 10 Code: 161500 Icon Type: Main</p>		<p>N/A</p>

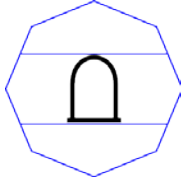
TABLE D-IV. Land unit icons - Continued.

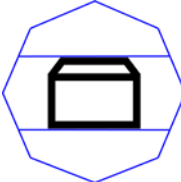
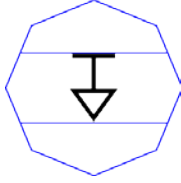
DESCRIPTION	ICON	REMARKS
<p>MORTUARY AFFAIRS/GRAVES REGISTRATION</p> <p>Type: Entity Type Entity: SUSTAINMENT Symbol Set Code: 10 Code: 161600 Icon Type: Main</p>		<p>N/A</p>
<p>MULTIPLE CLASSES OF SUPPLY</p> <p>Type: Entity Type Entity: SUSTAINMENT Symbol Set Code: 10 Code: 161700 Icon Type: Full Frame</p>		<p>The grey box is not to be drawn. It is shown here only as a reference to position and proportion of the icon within the frame.</p>
<p>NATO SUPPLY CLASS I</p> <p>Type: Entity Type Entity: SUSTAINMENT Symbol Set Code: 10 Code: 161800 Icon Type: Full Frame</p>		<p>These classes are referenced in NATO APP-6.</p> <p>Items of subsistence, e.g. food and forage, which are consumed by personnel or animals at an approximately uniform rate, irrespective of local changes in combat or terrain conditions.</p>
<p>NATO SUPPLY CLASS II</p> <p>Type: Entity Type Entity: SUSTAINMENT Symbol Set Code: 10 Code: 161900 Icon Type: Full Frame</p>		<p>These classes are referenced in NATO APP-6</p> <p>Supplies for which allowances are established by tables of organization and equipment, e.g. clothing, weapons, tools, spare parts, vehicles.</p>
<p>NATO SUPPLY CLASS III</p> <p>Type: Entity Type Entity: SUSTAINMENT Symbol Set Code: 10 Code: 162000 Icon Type: Full Frame</p>		<p>These classes are referenced in NATO APP-6</p> <p>Petroleum, oil and lubricants (POL) for all purposes, except for operating aircraft or for use in weapons such as flamethrowers, e.g. gasoline, fuel oil, greases, coal and coke. (Class IIIa - aviation fuel and lubricants)</p>

TABLE D-IV. Land unit icons - Continued.

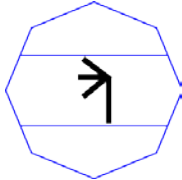
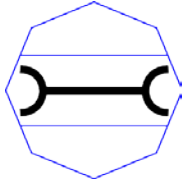
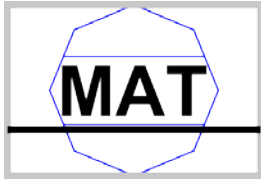
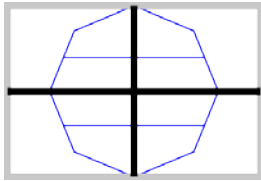
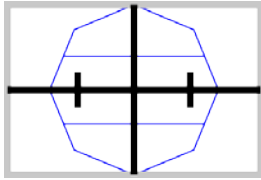

DESCRIPTION	ICON	REMARKS
<p>NATO SUPPLY CLASS IV</p> <p>Type: Entity Type Entity: SUSTAINMENT Symbol Set Code: 10 Code: 162100 Icon Type: Full Frame</p>		<p>These classes are referenced in NATO APP-6</p> <p>Supplies for which initial issue allowances are not prescribed by approved issue tables. Normally includes fortification and construction materials, as well as additional quantities of items identical to those authorized for initial issue (Class II) such as additional vehicles.</p>
<p>NATO SUPPLY CLASS V</p> <p>Type: Entity Type Entity: SUSTAINMENT Symbol Set Code: 10 Code: 162200 Icon Type: Full Frame</p>		<p>These classes are referenced in NATO APP-6</p> <p>Ammunition, explosives and chemical agents of all types.</p>
<p>ORDNANCE</p> <p>Type: Entity Type Entity: SUSTAINMENT Symbol Set Code: 10 Code: 162300 Icon Type: Main</p>		<p>N/A</p>
<p>PERSONNEL SERVICES</p> <p>Type: Entity Type Entity: SUSTAINMENT Symbol Set Code: 10 Code: 162400 Icon Type: Main</p>		<p>N/A</p>
<p>PETROLEUM, OIL AND LUBRICANTS</p> <p>Type: Entity Type Entity: SUSTAINMENT Symbol Set Code: 10 Code: 162500 Icon Type: Main</p>		<p>N/A</p>
<p>PIPELINE</p> <p>Type: Entity Type Entity: SUSTAINMENT Symbol Set Code: 10 Code: 162600 Icon Type: Main</p>		<p>N/A</p>

TABLE D-IV. Land unit icons - Continued.

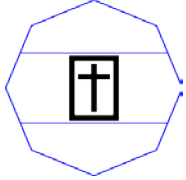
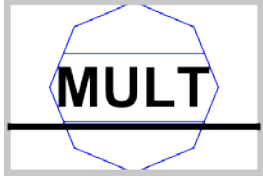
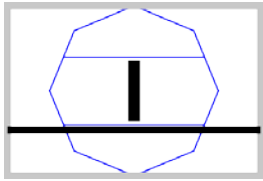
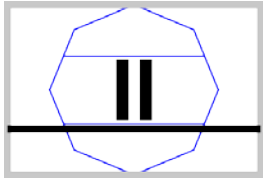
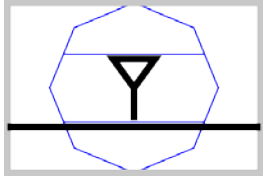

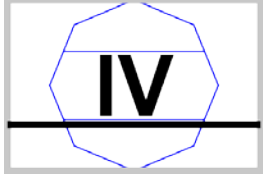
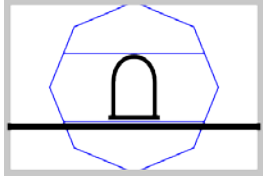
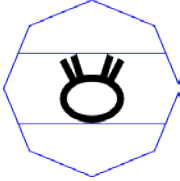

DESCRIPTION	ICON	REMARKS
POSTAL Type: Entity Type Entity: SUSTAINMENT Symbol Set Code: 10 Code: 162700 Icon Type: Main		N/A
PUBLIC AFFAIRS/PUBLIC INFORMATION Type: Entity Type Entity: SUSTAINMENT Symbol Set Code: 10 Code: 162800 Icon Type: Main		N/A
QUARTERMASTER Type: Entity Type Entity: SUSTAINMENT Symbol Set Code: 10 Code: 162900 Icon Type: Main		N/A
RAILHEAD Type: Entity Type Entity: SUSTAINMENT Symbol Set Code: 10 Code: 163000 Icon Type: Main+1		N/A
RELIGIOUS SUPPORT Type: Entity Type Entity: SUSTAINMENT Symbol Set Code: 10 Code: 163100 Icon Type: Main		N/A
REPLACEMENT HOLDING UNIT Type: Entity Type Entity: SUSTAINMENT Symbol Set Code: 10 Code: 163200 Icon Type: Main		N/A
SEAPORT OF DEBARKATION/ SEAPORT OF EMBARKATION Type: Entity Type Entity: SUSTAINMENT Symbol Set Code: 10 Code: 163300 Icon Type: Main+1		N/A

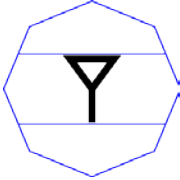
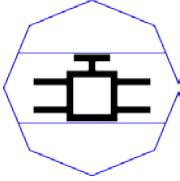
TABLE D-IV. Land unit icons - Continued.

DESCRIPTION	ICON	REMARKS
<p>SUPPLY</p> <p>Type: Entity Type Entity: SUSTAINMENT Symbol Set Code: 10 Code: 163400 Icon Type: Full Frame</p>		<p>The grey box is not to be drawn. It is shown here only as a reference to position and proportion of the icon within the frame.</p>
<p>JOINT INFORMATION BUREAU (JIB)</p> <p>Type: Entity Type Entity: SUSTAINMENT Symbol Set Code: 10 Code: 163500 Icon Type: Main</p>		<p>N/A</p>
<p>TRANSPORTATION</p> <p>Type: Entity Type Entity: SUSTAINMENT Symbol Set Code: 10 Code: 163600 Icon Type: Main</p>		<p>N/A</p>
<p>US SUPPLY CLASS I</p> <p>Type: Entity Type Entity: SUSTAINMENT Symbol Set Code: 10 Code: 163700 Icon Type: Full Frame</p>		<p>Referenced in STANAG 2961 Classes of Supply of NATO Land Forces</p> <p>Subsistence (food), gratuitous (free) health and comfort items.</p>
<p>US SUPPLY CLASS II</p> <p>Type: Entity Type Entity: SUSTAINMENT Symbol Set Code: 10 Code: 163800 Icon Type: Full Frame</p>		<p>Referenced in STANAG 2961 Classes of Supply of NATO Land Forces</p> <p>Individual equipment, tentage, organizational tool sets and kits, hand tools, unclassified maps, administrative and housekeeping supplies and equipment.</p>
<p>US SUPPLY CLASS III</p> <p>Type: Entity Type Entity: SUSTAINMENT Symbol Set Code: 10 Code: 163900 Icon Type: Full Frame</p>		<p>Referenced in STANAG 2961 Classes of Supply of NATO Land Forces</p> <p>Petroleum, Oil and Lubricants (POL) (package and bulk): Petroleum, fuels, lubricants, hydraulic and insulating oils, preservatives, liquids and gases, bulk chemical products, coolants, deicer and antifreeze compounds, components and additives of petroleum and chemical products and coal.</p>

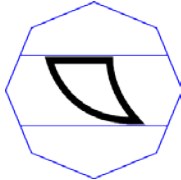
TABLE D-IV. Land unit icons - Continued.

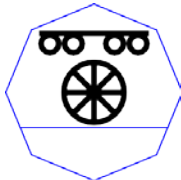
DESCRIPTION	ICON	REMARKS
US SUPPLY CLASS IV Type: Entity Type Entity: SUSTAINMENT Symbol Set Code: 10 Code: 164000 Icon Type: Full Frame		Referenced in STANAG 2961 Classes of Supply of NATO Land Forces Construction materials, including installed equipment and all fortification and barrier materials.
US SUPPLY CLASS V Type: Entity Type Entity: SUSTAINMENT Symbol Set Code: 10 Code: 164100 Icon Type: Full Frame		Referenced in STANAG 2961 Classes of Supply of NATO Land Forces Ammunition of all types, bombs, explosives, mines, fuses, detonators, pyrotechnics, missiles, rockets, propellants and associated items.
US SUPPLY CLASS VI Type: Entity Type Entity: SUSTAINMENT Symbol Set Code: 10 Code: 164200 Icon Type: Full Frame		Referenced in STANAG 2961 Classes of Supply of NATO Land Forces Personal demand items (such as health and hygiene products, soaps and toothpaste, writing material, snack food, beverages, cigarettes, batteries, alcohol and cameras—nonmilitary sales items).
US SUPPLY CLASS VII Type: Entity Type Entity: SUSTAINMENT Symbol Set Code: 10 Code: 164300 Icon Type: Full Frame		Referenced in STANAG 2961 Classes of Supply of NATO Land Forces Major end items such as launchers, tanks, mobile machine shops and vehicles.
US SUPPLY CLASS VIII Type: Entity Type Entity: SUSTAINMENT Symbol Set Code: 10 Code: 164400 Icon Type: Full Frame		Referenced in STANAG 2961 Classes of Supply of NATO Land Forces Medical material (equipment and consumables) including repair parts peculiar to medical equipment. (Class VIIIa – Medical consumable supplies not including blood & blood products; Class VIIIb – Blood & blood components (whole blood, platelets, plasma, packed red cells, etc.).)

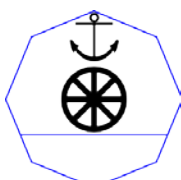
TABLE D-IV. Land unit icons - Continued.

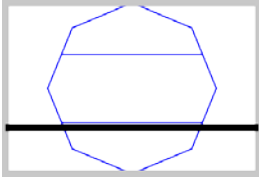
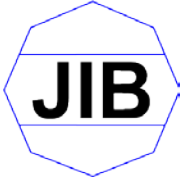
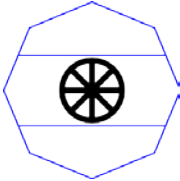
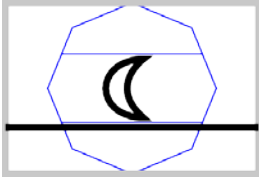
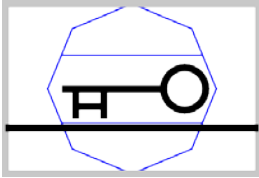
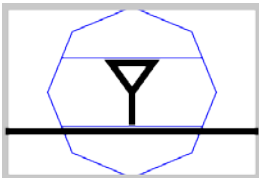

DESCRIPTION	ICON	REMARKS
<p>US SUPPLY CLASS IX</p> <p>Type: Entity Type Entity: SUSTAINMENT Symbol Set Code: 10 Code: 164500 Icon Type: Full Frame</p>		<p>Referenced in STANAG 2961 Classes of Supply of NATO Land Forces</p> <p>Repair parts and components to include kits, assemblies and subassemblies (repairable or non-repairable) required for maintenance support of all equipment.</p>
<p>US SUPPLY CLASS X</p> <p>Type: Entity Type Entity: SUSTAINMENT Symbol Set Code: 10 Code: 164600 Icon Type: Full Frame</p>		<p>Referenced in STANAG 2961 Classes of Supply of NATO Land Forces</p> <p>Material to support nonmilitary programs such as agriculture and economic development (not included in Classes I through IX).</p>
<p>WATER</p> <p>Type: Entity Type Entity: SUSTAINMENT Symbol Set Code: 10 Code: 164700 Icon Type: Main</p>		<p>N/A</p>
<p>WATER PURIFICATION</p> <p>Type: Entity Type Entity: SUSTAINMENT Symbol Set Code: 10 Code: 164800 Icon Type: Main</p>		<p>N/A</p>
<p>BROADCAST</p> <p>Type: Entity Type Entity: SUSTAINMENT Symbol Set Code: 10 Code: 164900 Icon Type: Main</p>		<p>N/A</p>
<p>NAVAL</p> <p>Type: Entity Entity: NAVAL Symbol Set Code: 10 Code: 170000</p>	<p>N/A</p>	<p>No icon is associated with this entity. It is for hierarchal purposes only.</p>

TABLE D-IV. Land unit icons - Continued.





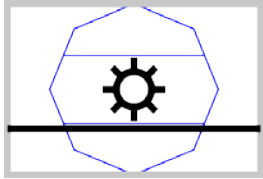
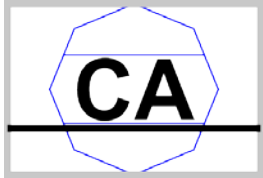
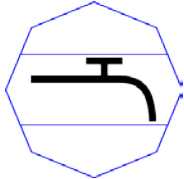

DESCRIPTION	ICON	REMARKS
<p>NAVAL</p> <p>Type: Entity Type Entity: NAVAL Symbol Set Code: 10 Code: 170100 Icon Type: Main</p>		<p>N/A</p>
<p>NAMED HEADQUARTERS</p> <p>Type: Entity Entity: NAMED HEADQUARTERS Symbol Set Code: 10 Code: 180000</p>	<p>N/A</p>	<p>No icon is associated with this entity. It is for hierarchal purposes only.</p>
<p>ALLIED COMMAND EUROPE RAPID REACTION CORPS (ARRC)</p> <p>Type: Entity Type Entity: NAMED HEADQUARTERS Symbol Set Code: 10 Code: 180100 Icon Type: Main</p>		<p>N/A</p>
<p>ALLIED COMMAND OPERATIONS</p> <p>Type: Entity Type Entity: NAMED HEADQUARTERS Symbol Set Code: 10 Code: 180200 Icon Type: Main</p>		<p>N/A</p>
<p>INTERNATIONAL SECURITY ASSISTANCE FORCE (ISAF)</p> <p>Type: Entity Type Entity: NAMED HEADQUARTERS Symbol Set Code: 10 Code: 180300 Icon Type: Main</p>		<p>N/A</p>
<p>MULTINATIONAL (MN)</p> <p>Type: Entity Type Entity: NAMED HEADQUARTERS Symbol Set Code: 10 Code: 180400 Icon Type: Main</p>		<p>N/A</p>
<p>EMERGENCY OPERATION</p> <p>Type: Entity Symbol Set Code: 10 Code: 190000 Icon Type: Full Octagon</p>		<p>N/A</p>

TABLE D-IV. Land unit icons - Continued.

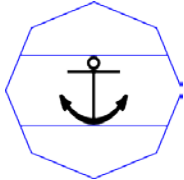





DESCRIPTION	ICON	REMARKS
LAW ENFORCEMENT Type: Entity Symbol Set Code: 10 Code: 200000 Icon Type: Full Octagon		N/A
BUREAU OF ALCOHOL, TOBACCO, FIREARMS AND EXPLOSIVES (ATF) (DEPARTMENT OF JUSTICE) Type: Entity Type Entity: LAW ENFORCEMENT Symbol Set Code: 10 Code: 200100 Icon Type: Main		N/A
BORDER PATROL Type: Entity Type Entity: LAW ENFORCEMENT Symbol Set Code: 10 Code: 200200 Icon Type: Full Octagon		N/A
CUSTOMS SERVICE Type: Entity Type Entity: LAW ENFORCEMENT Symbol Set Code: 10 Code: 200300 Icon Type: Full Octagon		N/A
DRUG ENFORCEMENT AGENCY (DEA) Type: Entity Type Entity: LAW ENFORCEMENT Symbol Set Code: 10 Code: 200400 Icon Type: Main		N/A
DEPARTMENT OF JUSTICE (DOJ) Type: Entity Type Entity: LAW ENFORCEMENT Symbol Set Code: 10 Code: 200500 Icon Type: Full Octagon		N/A

TABLE D-IV. Land unit icons - Continued.

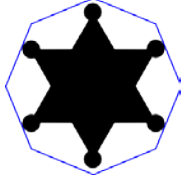





DESCRIPTION	ICON	REMARKS
FEDERAL BUREAU OF INVESTIGATION (FBI) Type: Entity Type Entity: LAW ENFORCEMENT Symbol Set Code: 10 Code: 200600 Icon Type: Main		N/A
POLICE Type: Entity Type Entity: LAW ENFORCEMENT Symbol Set Code: 10 Code: 200700 Icon Type: Main		N/A
PRISON Type: Entity Type Entity: LAW ENFORCEMENT Symbol Set Code: 10 Code: 200800 Icon Type: Full Octagon		N/A
UNITED STATES SECRET SERVICE(TREAS) (USSS) Type: Entity Type Entity: LAW ENFORCEMENT Symbol Set Code: 10 Code: 200900 Icon Type: Main		N/A
TRANSPORTATION SECURITY ADMINISTRATION (TSA) Type: Entity Type Entity: LAW ENFORCEMENT Symbol Set Code: 10 Code: 201000 Icon Type: Main		N/A
COAST GUARD Type: Entity Type Entity: LAW ENFORCEMENT Symbol Set Code: 10 Code: 201100 Icon Type: Full Octagon		N/A

TABLE D-IV. Land unit icons - Continued.

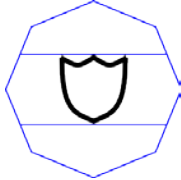
DESCRIPTION	ICON	REMARKS
<p>US MARSHALS SERVICE</p> <p>Type: Entity Type Entity: LAW ENFORCEMENT Symbol Set Code: 10 Code: 201200 Icon Type: Full Octagon</p>		N/A
<p>INTERNAL SECURITY FORCE</p> <p>Type: Entity Type Entity: LAW ENFORCEMENT Symbol Set Code: 10 Code: 201300 Icon Type: Main</p>		N/A



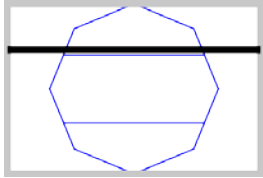
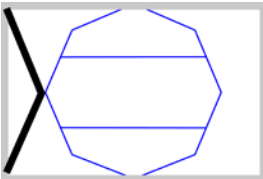
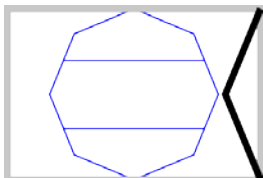
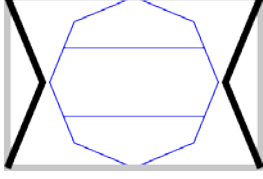

D.6.2.1 Land unit icons – special entity subtypes. Some entity type land unit icons may use the entity subtypes listed in [Table D-V](#).

TABLE D-V. Land unit icons – special entity subtypes.

DESCRIPTION	ICON	REMARKS
<p>HEADQUARTERS ELEMENT</p> <p>Type: Entity Subtype Symbol Set Code: 10 Code: xxxx95 Icon Type: Full Frame</p>		Code associated with this entity subtype is subject to the specific entity type.
<p>DIVISION AND BELOW SUPPORT</p> <p>Type: Entity Subtype Symbol Set Code: 10 Code: xxxx96 Icon Type: Full Frame</p>		Code associated with this entity subtype is subject to the specific entity type.
<p>CORPS SUPPORT</p> <p>Type: Entity Subtype Symbol Set Code: 10 Code: xxxx97 Icon Type: Full Frame</p>		Code associated with this entity subtype is subject to the specific entity type.
<p>THEATER/ECHELONS ABOVE CORPS SUPPORT</p> <p>Type: Entity Subtype Symbol Set Code: 10 Code: xxxx98 Icon Type: Full Frame</p>		Code associated with this entity subtype is subject to the specific entity type.

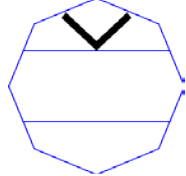
D.6.3 Land unit sector 1 modifiers. Land unit sector 1 modifiers denote mobility, capability and composite loss categories. [Table D-VI](#) lists land unit sector 1 modifiers and illustrates their placement within the bounding octagon.

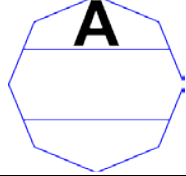
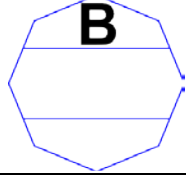
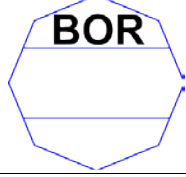
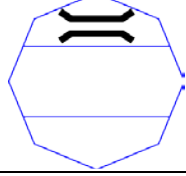
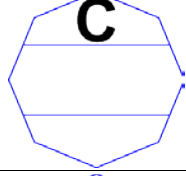
TABLE D-VI. Land unit sector 1 modifiers.

DESCRIPTION	CATEGORY	MODIFIER	REMARKS
AIR MOBILE/AIR ASSAULT Symbol Set Code: 10 Code: 01	MOBILITY		US only
AREA Symbol Set Code: 10 Code: 02	CAPABILITY		N/A
ATTACK Symbol Set Code: 10 Code: 03	CAPABILITY		N/A
BIOLOGICAL Symbol Set Code: 10 Code: 04	CAPABILITY		N/A
BORDER Symbol Set Code: 10 Code: 05	CAPABILITY		N/A
BRIDGING Symbol Set Code: 10 Code: 06	CAPABILITY		N/A
CHEMICAL Symbol Set Code: 10 Code: 07	CAPABILITY		N/A
CLOSE PROTECTION Symbol Set Code: 10 Code: 08	CAPABILITY		N/A

MIL-STD-2525D - APPENDIX D

TABLE D-VI. Land unit sector 1 modifiers – Continued.



DESCRIPTION	CATEGORY	MODIFIER	REMARKS
COMBAT Symbol Set Code: 10 Code: 09	CAPABILITY		N/A
COMMAND AND CONTROL Symbol Set Code: 10 Code: 10	CAPABILITY		N/A
COMMUNICATIONS CONTINGENCY PACKAGE Symbol Set Code: 10 Code: 11	CAPABILITY		N/A
CONSTRUCTION Symbol Set Code: 10 Code: 12	CAPABILITY		N/A
CROSS CULTURAL COMMUNICATION Symbol Set Code: 10 Code: 13	CAPABILITY		N/A
CROWD AND RIOT CONTROL Symbol Set Code: 10 Code: 14	CAPABILITY		N/A
DECONTAMINATION Symbol Set Code: 10 Code: 15	CAPABILITY		N/A
DETENTION Symbol Set Code: 10 Code: 16	CAPABILITY		N/A

TABLE D-VI. Land unit sector 1 modifiers – Continued.

DESCRIPTION	CATEGORY	MODIFIER	REMARKS
DIRECT COMMUNICATIONS Symbol Set Code: 10 Code: 17	CAPABILITY		N/A
DIVING Symbol Set Code: 10 Code: 18	CAPABILITY		N/A
DIVISION Symbol Set Code: 10 Code: 19	CAPABILITY		N/A
DOG Symbol Set Code: 10 Code: 20	CAPABILITY		N/A
DRILLING Symbol Set Code: 10 Code: 21	CAPABILITY		N/A
ELECTRO-OPTICAL Symbol Set Code: 10 Code: 22	CAPABILITY		N/A
ENHANCED Symbol Set Code: 10 Code: 23	CAPABILITY		N/A
EXPLOSIVE ORDNANCE DISPOSAL (EOD) Symbol Set Code: 10 Code: 24	CAPABILITY		N/A

TABLE D-VI. Land unit sector 1 modifiers – Continued.

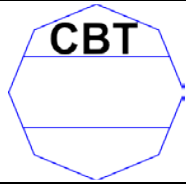
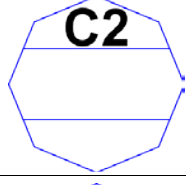
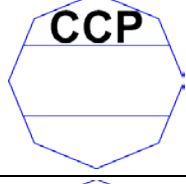
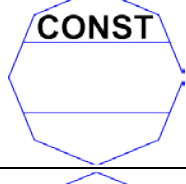
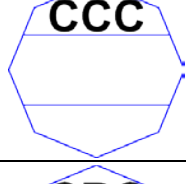
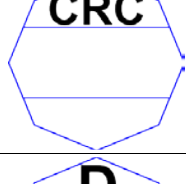
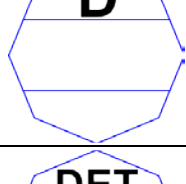

DESCRIPTION	CATEGORY	MODIFIER	REMARKS
FIRE DIRECTION CENTER Symbol Set Code: 10 Code: 25	CAPABILITY		N/A
FORCE Symbol Set Code: 10 Code: 26	CAPABILITY		N/A
FORWARD Symbol Set Code: 10 Code: 27	CAPABILITY		N/A
GROUND STATION MODULE Symbol Set Code: 10 Code: 28	CAPABILITY		N/A
LANDING SUPPORT Symbol Set Code: 10 Code: 29	CAPABILITY		N/A
LARGE EXTENSION NODE Symbol Set Code: 10 Code: 30	CAPABILITY		N/A
MAINTENANCE Symbol Set Code: 10 Code: 31	CAPABILITY		N/A
METEOROLOGICAL Symbol Set Code: 10 Code: 32	CAPABILITY		N/A

TABLE D-VI. Land unit sector 1 modifiers – Continued.

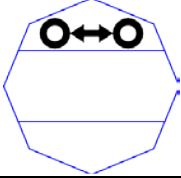
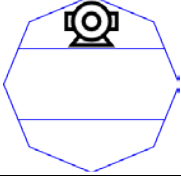
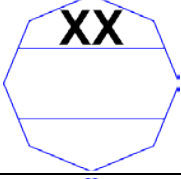
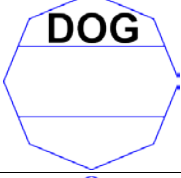
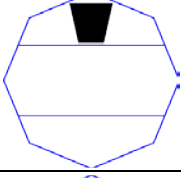
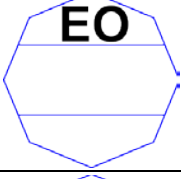
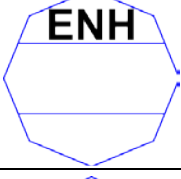
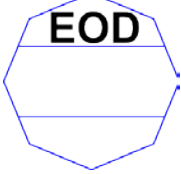
DESCRIPTION	CATEGORY	MODIFIER	REMARKS
MINE COUNTERMEASURE Symbol Set Code: 10 Code: 33	CAPABILITY		N/A
MISSILE Symbol Set Code: 10 Code: 34	CAPABILITY		N/A
MOBILE ADVISOR AND SUPPORT Symbol Set Code: 10 Code: 35	CAPABILITY		N/A
MOBILE SUBSCRIBER EQUIPMENT Symbol Set Code: 10 Code: 36	CAPABILITY		N/A
MOBILITY SUPPORT Symbol Set Code: 10 Code: 37	CAPABILITY		N/A
MOVEMENT CONTROL CENTER Symbol Set Code: 10 Code: 38	CAPABILITY		N/A
MULTINATIONAL Symbol Set Code: 10 Code: 39	CAPABILITY		N/A
MULTINATIONAL SPECIALIZED UNIT Symbol Set Code: 10 Code: 40	CAPABILITY		N/A

TABLE D-VI. Land unit sector 1 modifiers – Continued.

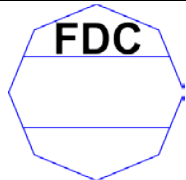
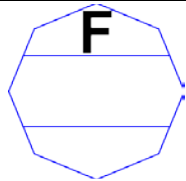
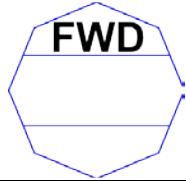

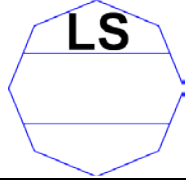
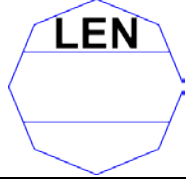
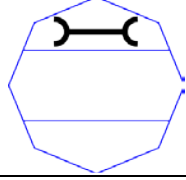
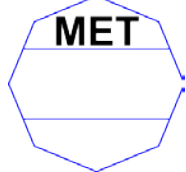

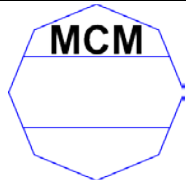
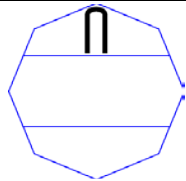
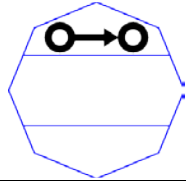
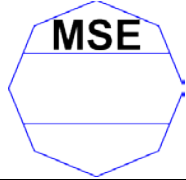
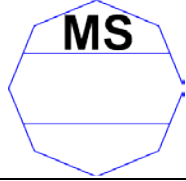
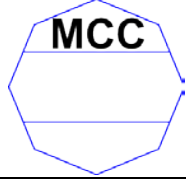
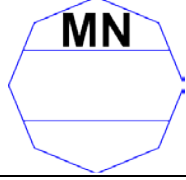
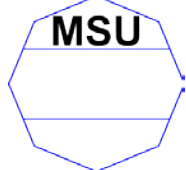

DESCRIPTION	CATEGORY	MODIFIER	REMARKS
MULTIPLE ROCKET LAUNCHER Symbol Set Code: 10 Code: 41	CAPABILITY		N/A
NATO MEDICAL ROLE 1 Symbol Set Code: 10 Code: 42	CAPABILITY		Modifier is offset so that the modifier is not compromised by the main sector icon.
NATO MEDICAL ROLE 2 Symbol Set Code: 10 Code: 43	CAPABILITY		Modifier is offset so that the modifier is not compromised by the main sector icon.
NATO MEDICAL ROLE 3 Symbol Set Code: 10 Code: 44	CAPABILITY		Modifier is offset so that the modifier is not compromised by the main sector icon.
NATO MEDICAL ROLE 4 Symbol Set Code: 10 Code: 45	CAPABILITY		Modifier is offset so that the modifier is not compromised by the main sector icon.
NAVAL Symbol Set Code: 10 Code: 46	CAPABILITY		N/A
NODE CENTER Symbol Set Code: 10 Code: 47	CAPABILITY		N/A
NUCLEAR Symbol Set Code: 10 Code: 48	CAPABILITY		N/A

TABLE D-VI. Land unit sector 1 modifiers – Continued.

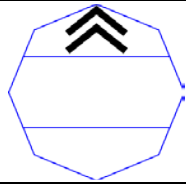
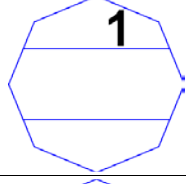
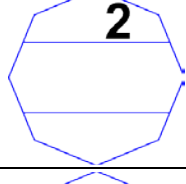
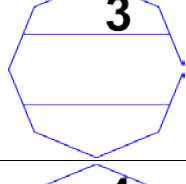
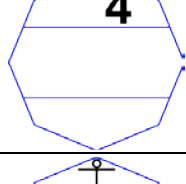
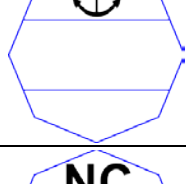
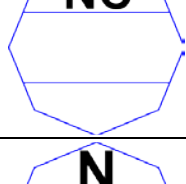
DESCRIPTION	CATEGORY	MODIFIER	REMARKS
OPERATIONS Symbol Set Code: 10 Code: 49	CAPABILITY		N/A
RADAR Symbol Set Code: 10 Code: 50	CAPABILITY		N/A
RADIO FREQUENCY IDENTIFICATION (RFID) INTERROGATOR/SENSOR Symbol Set Code: 10 Code: 51	CAPABILITY		N/A
RADIOLOGICAL Symbol Set Code: 10 Code: 52	CAPABILITY		N/A
SEARCH AND RESCUE Symbol Set Code: 10 Code: 53	CAPABILITY		N/A
SECURITY Symbol Set Code: 10 Code: 54	CAPABILITY		N/A
SENSOR Symbol Set Code: 10 Code: 55	CAPABILITY		N/A
SENSOR CONTROL MODULE (SCM) Symbol Set Code: 10 Code: 56	CAPABILITY		N/A

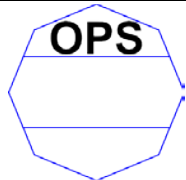
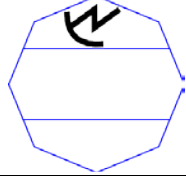
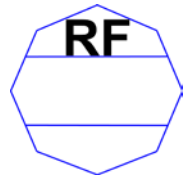
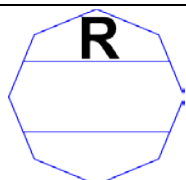
MIL-STD-2525D - APPENDIX D

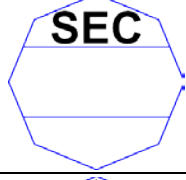
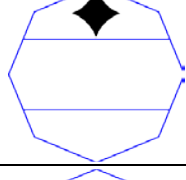
TABLE D-VI. Land unit sector 1 modifiers – Continued.

DESCRIPTION	CATEGORY	MODIFIER	REMARKS
SIGNALS INTELLIGENCE Symbol Set Code: 10 Code: 57	CAPABILITY		N/A
SINGLE SHELTER SWITCH Symbol Set Code: 10 Code: 58	CAPABILITY		N/A
SINGLE ROCKET LAUNCHER Symbol Set Code: 10 Code: 59	CAPABILITY		N/A
SMOKE Symbol Set Code: 10 Code: 60	CAPABILITY		N/A
SNIPER Symbol Set Code: 10 Code: 61	CAPABILITY		N/A
SOUND RANGING Symbol Set Code: 10 Code: 62	CAPABILITY		N/A
SPECIAL OPERATIONS FORCES (SOF) Symbol Set Code: 10 Code: 63	CAPABILITY		N/A
SPECIAL WEAPONS AND TACTICS Symbol Set Code: 10 Code: 64	CAPABILITY		N/A

TABLE D-VI. Land unit sector 1 modifiers – Continued.



DESCRIPTION	CATEGORY	MODIFIER	REMARKS
SURVEY Symbol Set Code: 10 Code: 65	CAPABILITY		N/A
TACTICAL EXPLOITATION Symbol Set Code: 10 Code: 66	CAPABILITY		N/A
TARGET ACQUISITION Symbol Set Code: 10 Code: 67	CAPABILITY		N/A
TOPOGRAPHIC Symbol Set Code: 10 Code: 68	CAPABILITY		N/A
UTILITY Symbol Set Code: 10 Code: 69	CAPABILITY		N/A
VIDEO IMAGERY (COMBAT CAMERA) Symbol Set Code: 10 Code: 70	CAPABILITY		N/A
ACCIDENT Symbol Set Code: 10 Code: 71	COMPOSITE LOSS		N/A
OTHER Symbol Set Code: 10 Code: 72	COMPOSITE LOSS		N/A

TABLE D-VI. Land unit sector 1 modifiers – Continued.

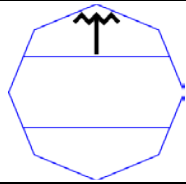
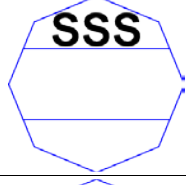
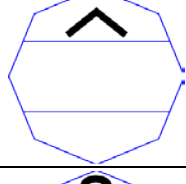
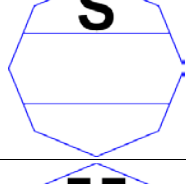
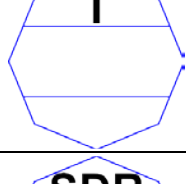
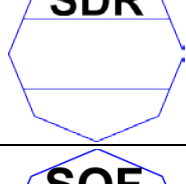
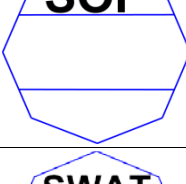
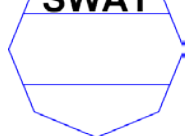
DESCRIPTION	CATEGORY	MODIFIER	REMARKS
CIVILIAN Symbol Set Code: 10 Code: 73	OPERATION		N/A
ANTISUBMARINE WARFARE Symbol Set Code: 10 Code: 74	CAPABILITY		N/A
MEDEVAC Symbol Set Code: 10 Code: 75	CAPABILITY		N/A
RANGER Symbol Set Code: 10 Code: 76	CAPABILITY		N/A
SUPPORT Symbol Set Code: 10 Code: 77	CAPABILITY		N/A
AVIATION Symbol Set Code: 10 Code: 78	CAPABILITY		N/A

D.6.4 Land unit sector 2 modifiers. Land unit sector 2 modifiers denote close range and control, mobility and capability categories. [Table D-VII](#) lists land unit sector 2 modifiers and illustrates their placement within the bounding octagon.

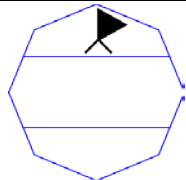
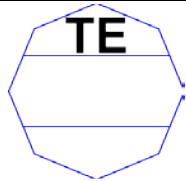
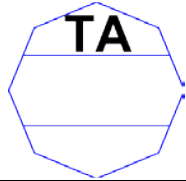
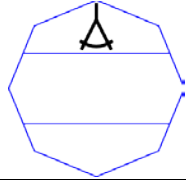
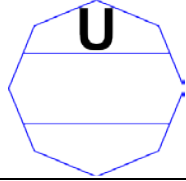
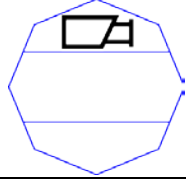
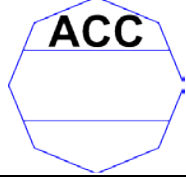
TABLE D-VII. Land unit sector 2 modifiers.

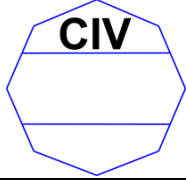
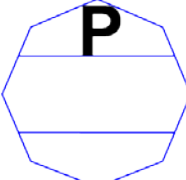
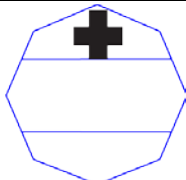
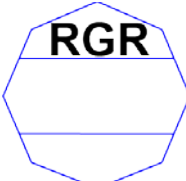
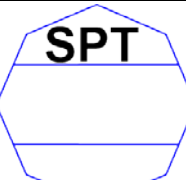
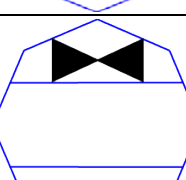
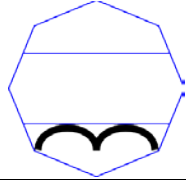
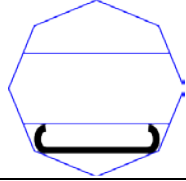
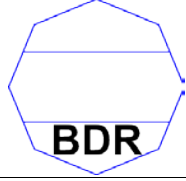
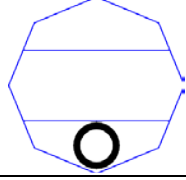
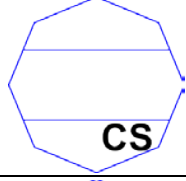
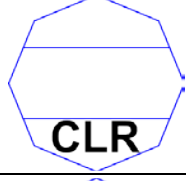
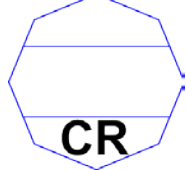
DESCRIPTION	CATEGORY	MODIFIER	REMARKS
AIRBORNE Symbol Set Code: 10 Code: 01	MOBILITY		N/A
ARCTIC Symbol Set Code: 10 Code: 02	MOBILITY		N/A
BATTLE DAMAGE REPAIR Symbol Set Code: 10 Code: 03	CAPABILITY		N/A
BICYCLE EQUIPPED Symbol Set Code: 10 Code: 04	MOBILITY		N/A
CASUALTY STAGING Symbol Set Code: 10 Code: 05	CAPABILITY		Modifier is offset so that the modifier is not compromised by the main sector icon.
CLEARING Symbol Set Code: 10 Code: 06	CAPABILITY		N/A
CLOSE RANGE Symbol Set Code: 10 Code: 07	CAPABILITY		N/A

MIL-STD-2525D - APPENDIX D

TABLE D-VII. Land unit sector 2 modifiers - Continued.

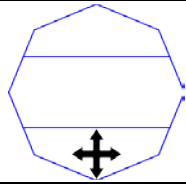
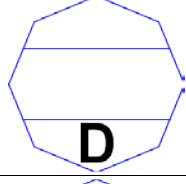
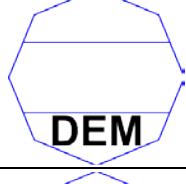
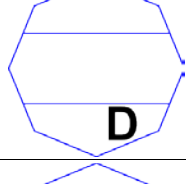
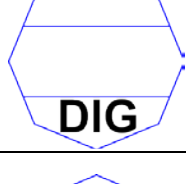
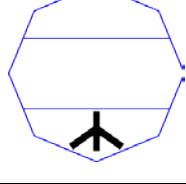
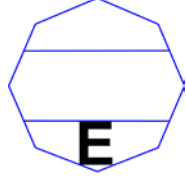
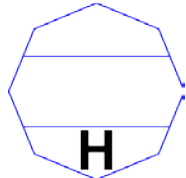
DESCRIPTION	CATEGORY	MODIFIER	REMARKS
CONTROL Symbol Set Code: 10 Code: 08	CAPABILITY		N/A
DECONTAMINATION Symbol Set Code: 10 Code: 09	CAPABILITY		N/A
DEMOLITION Symbol Set Code: 10 Code: 10	CAPABILITY		N/A
DENTAL Symbol Set Code: 10 Code: 11	CAPABILITY		Modifier is offset so that the modifier is not compromised by the main sector icon.
DIGITAL Symbol Set Code: 10 Code: 12	CAPABILITY		N/A
ENHANCED POSITION LOCATION REPORTING SYSTEM (EPLRS) Symbol Set Code: 10 Code: 13	CAPABILITY		N/A
EQUIPMENT Symbol Set Code: 10 Code: 14	CAPABILITY		APP6
HEAVY Symbol Set Code: 10 Code: 15	CAPABILITY		N/A

MIL-STD-2525D - APPENDIX D

TABLE D-VII. Land unit sector 2 modifiers - Continued.

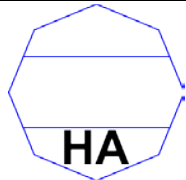
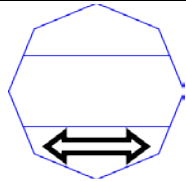
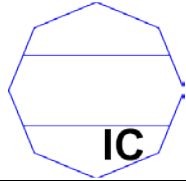
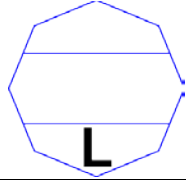
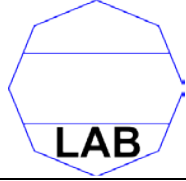
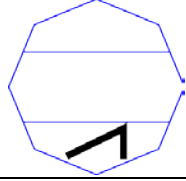
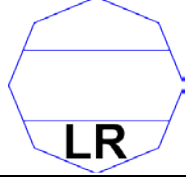
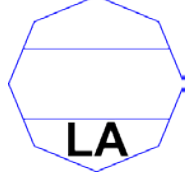
DESCRIPTION	CATEGORY	MODIFIER	REMARKS
HIGH ALTITUDE Symbol Set Code: 10 Code: 16	CAPABILITY		N/A
INTERMODAL Symbol Set Code: 10 Code: 17	CAPABILITY		N/A
INTENSIVE CARE Symbol Set Code: 10 Code: 18	CAPABILITY		Modifier is offset so that the modifier is not compromised by the main sector icon.
LIGHT Symbol Set Code: 10 Code: 19	CAPABILITY		N/A
LABORATORY Symbol Set Code: 10 Code: 20	CAPABILITY		N/A
LAUNCHER Symbol Set Code: 10 Code: 21	CAPABILITY		N/A
LONG RANGE Symbol Set Code: 10 Code: 22	CAPABILITY		N/A
LOW ALTITUDE Symbol Set Code: 10 Code: 23	CAPABILITY		N/A

MIL-STD-2525D - APPENDIX D

TABLE D-VII. Land unit sector 2 modifiers - Continued.

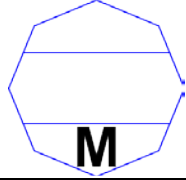
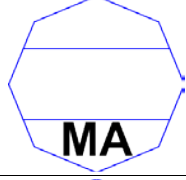
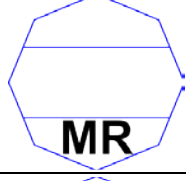
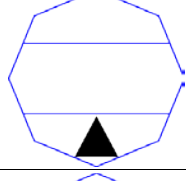
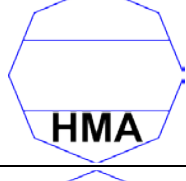
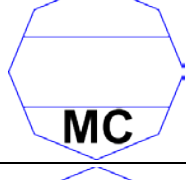
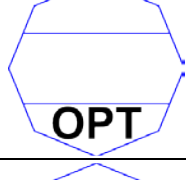
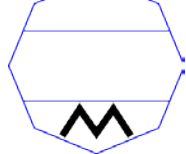
DESCRIPTION	CATEGORY	MODIFIER	REMARKS
MEDIUM Symbol Set Code: 10 Code: 24	CAPABILITY		N/A
MEDIUM ALTITUDE Symbol Set Code: 10 Code: 25	CAPABILITY		N/A
MEDIUM RANGE Symbol Set Code: 10 Code: 26	CAPABILITY		N/A
MOUNTAIN Symbol Set Code: 10 Code: 27	CAPABILITY		N/A
HIGH TO MEDIUM ALTITUDE Symbol Set Code: 10 Code: 28	CAPABILITY		N/A
MULTI-CHANNEL Symbol Set Code: 10 Code: 29	CAPABILITY		N/A
OPTICAL (FLASH) Symbol Set Code: 10 Code: 30	CAPABILITY		N/A
PACK ANIMAL Symbol Set Code: 10 Code: 31	CAPABILITY		N/A

MIL-STD-2525D - APPENDIX D

TABLE D-VII. Land unit sector 2 modifiers - Continued.

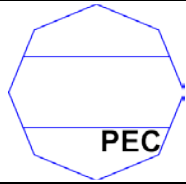
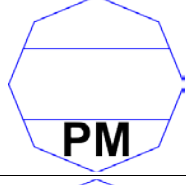
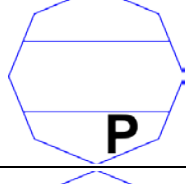
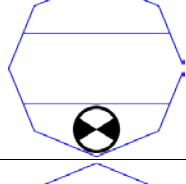
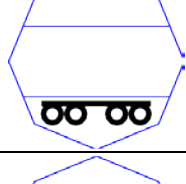
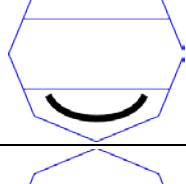
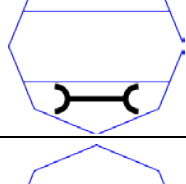
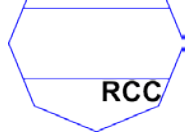
DESCRIPTION	CATEGORY	MODIFIER	REMARKS
PATIENT EVACUATION COORDINATION Symbol Set Code: 10 Code: 32	CAPABILITY		Modifier is offset so that the modifier is not compromised by the main sector icon.
PREVENTIVE MAINTENANCE Symbol Set Code: 10 Code: 33	CAPABILITY		N/A
PSYCHOLOGICAL Symbol Set Code: 10 Code: 34	CAPABILITY		Modifier is offset so that the modifier is not compromised by the main sector icon.
RADIO RELAY LINE OF SIGHT Symbol Set Code: 10 Code: 35	CAPABILITY		N/A
RAILROAD Symbol Set Code: 10 Code: 36	MOBILITY		N/A
RECOVERY (UNMANNED SYSTEMS) Symbol Set Code: 10 Code: 37	CAPABILITY		N/A
RECOVERY (MAINTENANCE) Symbol Set Code: 10 Code: 38	CAPABILITY		N/A
RESCUE COORDINATION CENTER Symbol Set Code: 10 Code: 39	CAPABILITY		Modifier is offset so that the modifier is not compromised by the main sector icon.

MIL-STD-2525D - APPENDIX D

TABLE D-VII. Land unit sector 2 modifiers - Continued.

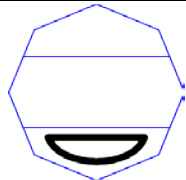
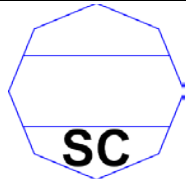
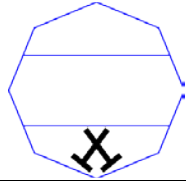
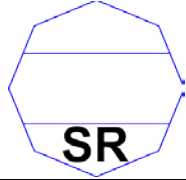
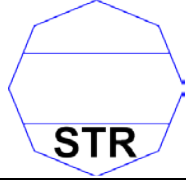
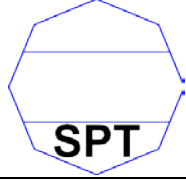
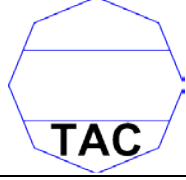
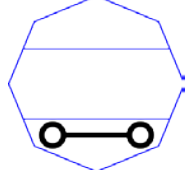
DESCRIPTION	CATEGORY	MODIFIER	REMARKS
RIVERINE Symbol Set Code: 10 Code: 40	MOBILITY		N/A
SINGLE CHANNEL Symbol Set Code: 10 Code: 41	CAPABILITY		N/A
SKI Symbol Set Code: 10 Code: 42	MOBILITY		N/A
SHORT RANGE Symbol Set Code: 10 Code: 43	CAPABILITY		N/A
STRATEGIC Symbol Set Code: 10 Code: 44	CAPABILITY		N/A
SUPPORT Symbol Set Code: 10 Code: 45	CAPABILITY		N/A
TACTICAL Symbol Set Code: 10 Code: 46	CAPABILITY		N/A
TOWED Symbol Set Code: 10 Code: 47	MOBILITY		N/A

MIL-STD-2525D - APPENDIX D

TABLE D-VII. Land unit sector 2 modifiers - Continued.

DESCRIPTION	CATEGORY	MODIFIER	REMARKS
TROOP Symbol Set Code: 10 Code: 48	CAPABILITY		N/A
VERTICAL TAKE-OFF AND LANDING (VTOL/VSTOL) Symbol Set Code: 10 Code: 49	MOBILITY		N/A
VETERINARY Symbol Set Code: 10 Code: 50	CAPABILITY		Modifier is offset so that the modifier is not compromised by the main sector icon.
WHEELED Symbol Set Code: 10 Code: 51	MOBILITY		N/A
HIGH TO LOW ALTITUDE Symbol Set Code: 10 Code: 52	CAPABILITY		N/A
MEDIUM TO LOW ALTITUDE Symbol Set Code: 10 Code: 53	CAPABILITY		N/A
ATTACK Symbol Set Code: 10 Code: 54	CAPABILITY		N/A
REFUEL Symbol Set Code: 10 Code: 55	CAPABILITY		N/A

TABLE D-VII. Land unit sector 2 modifiers - Continued.

DESCRIPTION	CATEGORY	MODIFIER	REMARKS
UTILITY Symbol Set Code: 10 Code: 56	CAPABILITY		N/A
COMBAT SEARCH AND RESCUE Symbol Set Code: 10 Code: 57	CAPABILITY		N/A

D.7 LAND CIVILIAN INDIVIDUALS/ORGANIZATION SYMBOLS

D.7.1 Land civilian individuals/organization symbols. This section includes the lists of icons and modifiers for building land civilian unit symbols.

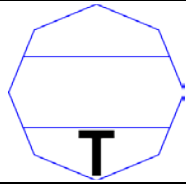
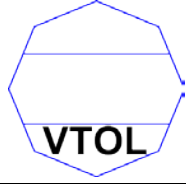
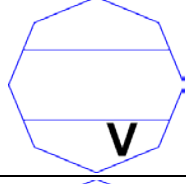
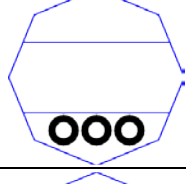
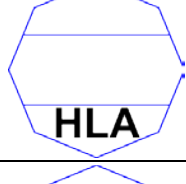
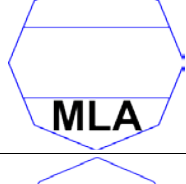
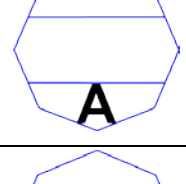
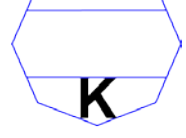
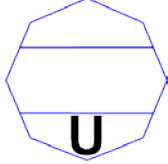
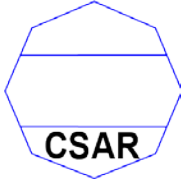
D.7.2 Land civilian individuals/organization icons. [Table D-VIII](#) depicts land civilian unit icons.

TABLE D-VIII. Land civilian individuals/organization icons.



DESCRIPTION	ICON	REMARKS
CIVILIAN Type: Entity Symbol Set Code: 11 Code: 110000 Icon Type: Main		This symbol shall not be displayed on a C2 system but may be displayed for training or hierarchal explanation purposes.
ENVIRONMENTAL PROTECTION Type: Entity Type Entity: CIVILIAN Symbol Set Code: 11 Code: 110100 Icon Type: Main		N/A
GOVERNMENT ORGANIZATION Type: Entity Type Entity: CIVILIAN Symbol Set Code: 11 Code: 110200 Icon Type: Main		N/A

TABLE D-VIII. Land civilian individuals/organization icons - Continued.



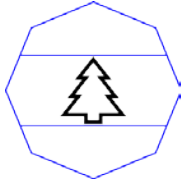

DESCRIPTION	ICON	REMARKS
<p>INDIVIDUAL</p> <p>Type: Entity Type Entity: CIVILIAN Symbol Set Code: 11 Code: 110300 Icon Type: Main</p>		<p>N/A</p>
<p>ORGANIZATION OR GROUP</p> <p>Type: Entity Type Entity: CIVILIAN Symbol Set Code: 11 Code: 110400 Icon Type: Main</p>		<p>N/A</p>
<p>KILLING VICTIM</p> <p>Type: Entity Type Entity: CIVILIAN Symbol Set Code: 11 Code: 110500 Icon Type: Main</p>		<p>N/A</p>
<p>KILLING VICTIMS</p> <p>Type: Entity Type Entity: CIVILIAN Symbol Set Code: 11 Code: 110600 Icon Type: Main</p>		<p>N/A</p>
<p>VICTIM OF AN ATTEMPTED CRIME</p> <p>Type: Entity Type Entity: CIVILIAN Symbol Set Code: 11 Code: 110700 Icon Type: Main</p>		<p>N/A</p>
<p>SPY</p> <p>Type: Entity Type Entity: CIVILIAN Symbol Set Code: 11 Code: 110800 Icon Type: Main</p>		<p>N/A</p>
<p>COMPOSITE LOSS</p> <p>Type: Entity Type Entity: CIVILIAN Symbol Set Code: 11 Code: 110900 Icon Type: Main</p>		<p>N/A</p>

TABLE D-VIII. Land civilian individuals/organization icons - Continued.

DESCRIPTION	ICON	REMARKS
EMERGENCY MEDICAL OPERATION Type: Entity Type Entity: CIVILIAN Symbol Set Code: 11 Code: 111000 Icon Type: Full Octagon		N/A

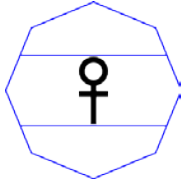
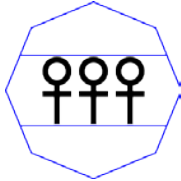
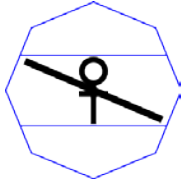
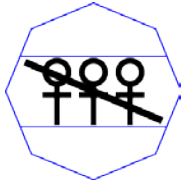
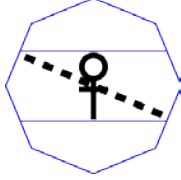
D.7.3 Land civilian unit/organization sector 1 modifiers. Land civilian unit sector 1 modifiers denote crime and organization categories. [Table D-IX](#) lists land civilian unit sector 1 modifiers and illustrates their placement within the bounding octagon.

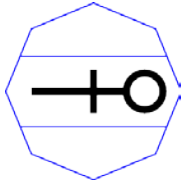
TABLE D-IX. Land civilian unit/organization sector 1 modifiers.

DESCRIPTION	CATEGORY	MODIFIER	REMARKS
ASSASSINATION Symbol Set Code: 11 Code: 01	CRIME		N/A
EXECUTION (WRONGFUL KILLING) Symbol Set Code: 11 Code: 02	CRIME		N/A
MURDER VICTIMS Symbol Set Code: 11 Code: 03	CRIME		N/A
HIJACKING Symbol Set Code: 11 Code: 04	CRIME		N/A
KIDNAPPING Symbol Set Code: 11 Code: 05	CRIME		N/A

TABLE D-IX. Land civilian unit/organization sector 1 modifiers - Continued.



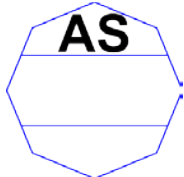
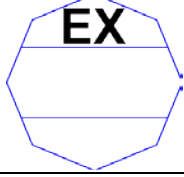
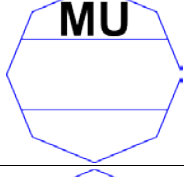
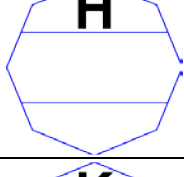
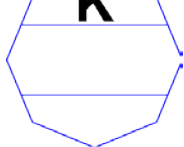

DESCRIPTION	CATEGORY	MODIFIER	REMARKS
PIRACY Symbol Set Code: 11 Code: 06	CRIME		N/A
RAPE Symbol Set Code: 11 Code: 07	CRIME		N/A
CIVILIAN Symbol Set Code: 11 Code: 08	ORGANIZATION		N/A
DISPLACED PERSON(S), REFUGEE(S) AND EVACUEE(S) Symbol Set Code: 11 Code: 09	ORGANIZATION		N/A
FOREIGN FIGHTER(S) Symbol Set Code: 11 Code: 10	ORGANIZATION		N/A
GANG MEMBER OR GANG Symbol Set Code: 11 Code: 11	ORGANIZATION		N/A
GOVERNMENT ORGANIZATION Symbol Set Code: 11 Code: 12	ORGANIZATION		N/A
LEADER OR LEADERSHIP Symbol Set Code: 11 Code: 13	ORGANIZATION		N/A

TABLE D-IX. Land civilian unit/organization sector 1 modifiers - Continued.



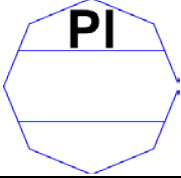
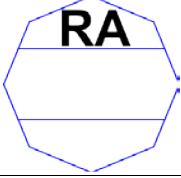
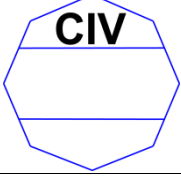

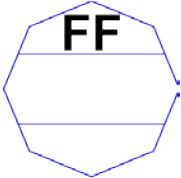
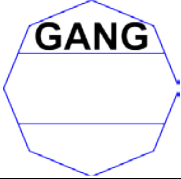
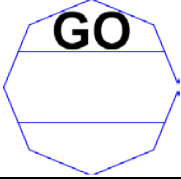

DESCRIPTION	CATEGORY	MODIFIER	REMARKS
NONGOVERNMENTAL ORGANIZATION MEMBER OR NONGOVERNMENTAL ORGANIZATION Symbol Set Code: 11 Code: 14	ORGANIZATION		N/A
COERCED/IMPRESSED RECRUIT Symbol Set Code: 11 Code: 15	ORGANIZATION		N/A
WILLING RECRUIT Symbol Set Code: 11 Code: 16	ORGANIZATION		N/A
RELIGIOUS OR RELIGIOUS ORGANIZATION Symbol Set Code: 11 Code: 17	ORGANIZATION		N/A
TARGETED INDIVIDUAL OR ORGANIZATION Symbol Set Code: 11 Code: 18	ORGANIZATION		N/A
TERRORIST OR TERRORIST ORGANIZATION Symbol Set Code: 11 Code: 19	ORGANIZATION		N/A
SPEAKER Symbol Set Code: 11 Code: 20	ORGANIZATION		N/A

TABLE D-IX. Land civilian unit/organization sector 1 modifiers - Continued.

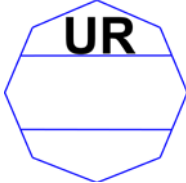
DESCRIPTION	CATEGORY	MODIFIER	REMARKS
ACCIDENT Symbol Set Code: 11 Code: 21	COMPOSITE LOSS		N/A
COMBAT Symbol Set Code: 11 Code: 22	COMPOSITE LOSS		N/A
OTHER Symbol Set Code: 11 Code: 23	COMPOSITE LOSS		N/A
LOOT Symbol Set Code: 11 Code: 24	CRIME		N/A

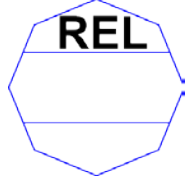
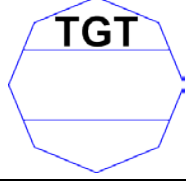
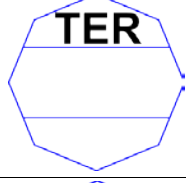
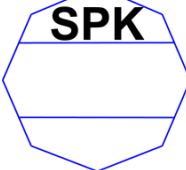
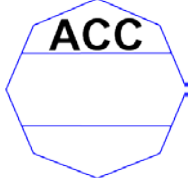
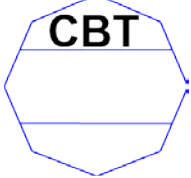
D.7.4 Land civilian unit sector 2 modifiers. Land civilian unit sector 2 modifiers denote organization category. [Table D-X](#) lists the land civilian unit sector 2 modifiers and illustrates their placement within the bounding octagon.

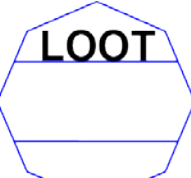
TABLE D-X. Land civilian unit/organization sector 2 modifiers.

DESCRIPTION	CATEGORY	MODIFIER	REMARKS
LEADER OR LEADERSHIP Symbol Set Code: 11 Code: 01	ORGANIZATION		N/A

D.8 LAND EQUIPMENT SYMBOLS

D.8.1 Land equipment symbols. This section includes the lists of icons and modifiers for building land equipment symbols.

D.8.2 Land equipment icons. [Table D-XI](#) depicts land equipment icons.

TABLE D-XI. Land equipment icons.

DESCRIPTION	ICON	REMARKS
<p>WEAPON/WEAPON SYSTEM</p> <p>Type: Entity Symbol Set Code: 15 Code: 110000 Icon Type: Full Octagon</p>		<p>This symbol shall not be displayed on a C2 system but may be displayed for training or hierarchal explanation purposes.</p>
<p>RIFLES</p> <p>Type: Entity Type Entity: WEAPON/WEAPON SYSTEM Symbol Set Code: 15 Code: 110100 Icon Type: Full Octagon</p>		<p>N/A</p>
<p>SINGLE SHOT RIFLE</p> <p>Type: Entity Subtype Entity/Entity Type: WEAPON/WEAPON SYSTEM/RIFLE Symbol Set Code: 15 Code: 110101 Icon Type: Full Octagon</p>		<p>N/A</p>
<p>SEMIAUTOMATIC RIFLE</p> <p>Type: Entity Subtype Entity/Entity Type: WEAPON/WEAPON SYSTEM/RIFLE Symbol Set Code: 15 Code: 110102 Icon Type: Full Octagon</p>		<p>N/A</p>
<p>AUTOMATIC RIFLE</p> <p>Type: Entity Subtype Entity/Entity Type: WEAPON/WEAPON SYSTEM/RIFLE Symbol Set Code: 15 Code: 110103 Icon Type: Full Octagon</p>		<p>N/A</p>

TABLE D-XI. Land equipment icons - Continued.

DESCRIPTION	ICON	REMARKS
MACHINE GUN Type: Entity Type Entity: WEAPON/WEAPON SYSTEM Symbol Set Code: 15 Code: 110200 Icon Type: Full Octagon		N/A
MACHINE GUN – LIGHT Type: Entity Subtype Entity/Entity Type: WEAPON/WEAPON SYSTEM/MACHINE GUN Symbol Set Code: 15 Code: 110201 Icon Type: Full Octagon		N/A
MACHINE GUN – MEDIUM Type: Entity Subtype Entity/Entity Type: WEAPON/WEAPON SYSTEM/MACHINE GUN Symbol Set Code: 15 Code: 110202 Icon Type: Full Octagon		N/A
MACHINE GUN – HEAVY Type: Entity Subtype Entity/Entity Type: WEAPON/WEAPON SYSTEM/MACHINE GUN Symbol Set Code: 15 Code: 110203 Icon Type: Full Octagon		N/A
GRENADE LAUNCHER Type: Entity Type Entity/Entity Type: WEAPON/WEAPON SYSTEM/GRENADE LAUNCHER Symbol Set Code: 15 Code: 110300 Icon Type: Full Octagon		N/A

TABLE D-XI. Land equipment icons - Continued.

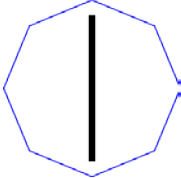
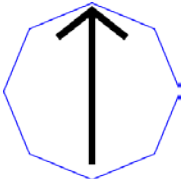
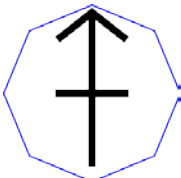
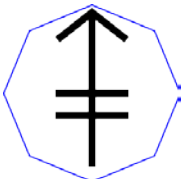
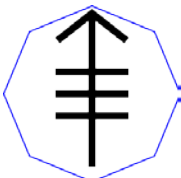

DESCRIPTION	ICON	REMARKS
<p>GRENADE LAUNCHER – LIGHT</p> <p>Type: Entity Subtype Entity/Entity Type: WEAPON/WEAPON SYSTEM/GRENADE LAUNCHER Symbol Set Code: 15 Code: 110301 Icon Type: Full Octagon</p>		<p>N/A</p>
<p>GRENADE LAUNCHER – MEDIUM</p> <p>Type: Entity Subtype Entity/Entity Type: WEAPON/WEAPON SYSTEM/GRENADE LAUNCHER Symbol Set Code: 15 Code: 110302 Icon Type: Full Octagon</p>		<p>N/A</p>
<p>GRENADE LAUNCHER – HEAVY</p> <p>Type: Entity Subtype Entity/Entity Type: WEAPON/WEAPON SYSTEM/GRENADE LAUNCHER Symbol Set Code: 15 Code: 110303 Icon Type: Full Octagon</p>		<p>N/A</p>
<p>FLAME THROWER</p> <p>Type: Entity Type Entity: WEAPON/WEAPON SYSTEM Symbol Set Code: 15 Code: 110400 Icon Type: Full Octagon</p>		<p>N/A</p>
<p>AIR DEFENSE GUNS</p> <p>Type: Entity Subtype Entity/Entity Type: WEAPON/WEAPON SYSTEM/GUN Symbol Set Code: 15 Code: 110500 Icon Type: Full Octagon</p>		<p>N/A</p>

TABLE D-XI. Land equipment icons - Continued.

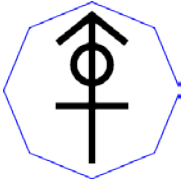
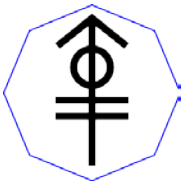

DESCRIPTION	ICON	REMARKS
<p>AIR DEFENSE GUN – LIGHT</p> <p>Type: Entity Subtype Entity/Entity Type: WEAPON/WEAPON SYSTEM/AIR DEFENSE GUN Symbol Set Code: 15 Code: 110501 Icon Type: Full Octagon</p>		<p>N/A</p>
<p>AIR DEFENSE GUN – MEDIUM</p> <p>Type: Entity Subtype Entity/Entity Type: WEAPON/WEAPON SYSTEM/AIR DEFENSE GUN Symbol Set Code: 15 Code: 110502 Icon Type: Full Octagon</p>		<p>N/A</p>
<p>AIR DEFENSE GUN – HEAVY</p> <p>Type: Entity Subtype Entity/Entity Type: WEAPON/WEAPON SYSTEM/AIR DEFENSE GUN Symbol Set Code: 15 Code: 110503 Icon Type: Full Octagon</p>		<p>N/A</p>
<p>ANTITANK GUNS</p> <p>Type: Entity Subtype Entity/Entity Type: WEAPON/WEAPON SYSTEM/ ANTITANK GUN Symbol Set Code: 15 Code: 110600 Icon Type: Full Octagon</p>		<p>N/A</p>
<p>ANTITANK GUN – LIGHT</p> <p>Type: Entity Subtype Entity/Entity Type: WEAPON/WEAPON SYSTEM/ ANTITANK GUN Symbol Set Code: 15 Code: 110601 Icon Type: Full Octagon</p>		<p>N/A</p>

TABLE D-XI. Land equipment icons - Continued.

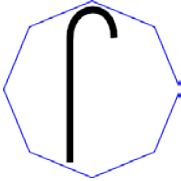
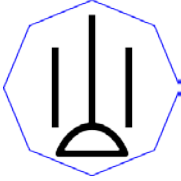
DESCRIPTION	ICON	REMARKS
<p>ANTITANK GUN – MEDIUM</p> <p>Type: Entity Subtype Entity/Entity Type: WEAPON/WEAPON SYSTEM/ANTITANK GUN Symbol Set Code: 15 Code: 110602 Icon Type: Full Octagon</p>		<p>N/A</p>
<p>ANTITANK GUN – HEAVY</p> <p>Type: Entity Subtype Entity/Entity Type: WEAPON/WEAPON SYSTEM/ANTITANK GUN Symbol Set Code: 15 Code: 110603 Icon Type: Full Octagon</p>		<p>N/A</p>
<p>DIRECT FIRE GUNS</p> <p>Type: Entity Subtype Entity/Entity Type: WEAPON/WEAPON SYSTEM/DIRECT FIRE GUN Symbol Set Code: 15 Code: 110700 Icon Type: Full Octagon</p>		<p>N/A</p>
<p>DIRECT FIRE GUN – LIGHT</p> <p>Type: Entity Subtype Entity/Entity Type: WEAPON/WEAPON SYSTEM/ DIRECT FIRE GUN Symbol Set Code: 15 Code: 110701 Icon Type: Full Octagon</p>		<p>N/A</p>
<p>DIRECT FIRE GUN – MEDIUM</p> <p>Type: Entity Subtype Entity/Entity Type: WEAPON/WEAPON SYSTEM/DIRECT FIRE GUN Symbol Set Code: 15 Code: 110702 Icon Type: Full Octagon</p>		<p>N/A</p>

TABLE D-XI. Land equipment icons - Continued.

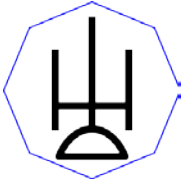
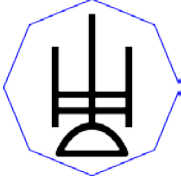
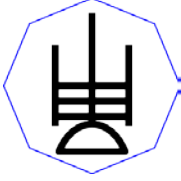
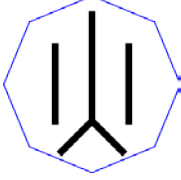

DESCRIPTION	ICON	REMARKS
<p>DIRECT FIRE GUN – HEAVY</p> <p>Type: Entity Subtype Entity/Entity Type: WEAPON/WEAPON SYSTEM/DIRECT FIRE GUN Symbol Set Code: 15 Code: 110703 Icon Type: Full Octagon</p>		<p>N/A</p>
<p>RECOILLESS GUNS</p> <p>Type: Entity Subtype Entity/Entity Type: WEAPON/WEAPON SYSTEM/ RECOILLESS GUN Symbol Set Code: 15 Code: 110800 Icon Type: Full Octagon</p>		<p>N/A</p>
<p>RECOILLESS GUN – LIGHT</p> <p>Type: Entity Subtype Entity/Entity Type: WEAPON/WEAPON SYSTEM/ RECOILLESS GUN Symbol Set Code: 15 Code: 110801 Icon Type: Full Octagon</p>		<p>N/A</p>
<p>RECOILLESS GUN – MEDIUM</p> <p>Type: Entity Subtype Entity/Entity Type: WEAPON/WEAPON SYSTEM/RECOILLESS GUN Symbol Set Code: 15 Code: 110802 Icon Type: Full Octagon</p>		<p>N/A</p>
<p>RECOILLESS GUN – HEAVY</p> <p>Type: Entity Subtype Entity/Entity Type: WEAPON/WEAPON SYSTEM/ RECOILLESS GUN Symbol Set Code: 15 Code: 110803 Icon Type: Full Octagon</p>		<p>N/A</p>

TABLE D-XI. Land equipment icons - Continued.

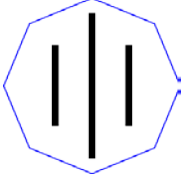
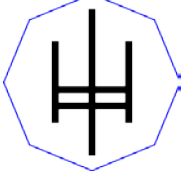

DESCRIPTION	ICON	REMARKS
<p>HOWITZERS</p> <p>Type: Entity Type Entity: WEAPON/WEAPON SYSTEM Symbol Set Code: 15 Code: 110900 Icon Type: Full Octagon</p>		<p>N/A</p>
<p>HOWITZER – LIGHT</p> <p>Type: Entity Subtype Entity/Entity Type: WEAPON/WEAPON SYSTEM/HOWITZER Symbol Set Code: 15 Code: 110901 Icon Type: Full Octagon</p>		<p>N/A</p>
<p>HOWITZER – MEDIUM</p> <p>Type: Entity Subtype Entity/Entity Type: WEAPON/WEAPON SYSTEM/HOWITZER Symbol Set Code: 15 Code: 110902 Icon Type: Full Octagon</p>		<p>N/A</p>
<p>HOWITZER – HEAVY</p> <p>Type: Entity Subtype Entity/Entity Type: WEAPON/WEAPON SYSTEM/HOWITZER Symbol Set Code: 15 Code: 110903 Icon Type: Full Octagon</p>		<p>N/A</p>
<p>MISSILE LAUNCHERS</p> <p>Type: Entity Type Entity: WEAPON/WEAPON SYSTEM Symbol Set Code: 15 Code: 111000 Icon Type: Full Octagon</p>		<p>N/A</p>
<p>MISSILE LAUNCHER – LIGHT</p> <p>Entity/Entity Subtype: WEAPON/WEAPON SYSTEM/MISSILE LAUNCHER Symbol Set Code: 15 Code: 111001 Icon Type: Full Octagon</p>		<p>N/A</p>

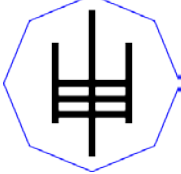
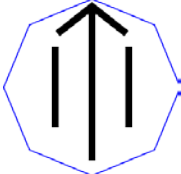
TABLE D-XI. Land equipment icons - Continued.

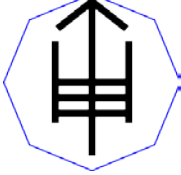

DESCRIPTION	ICON	REMARKS
<p>MISSILE LAUNCHER – MEDIUM</p> <p>Entity/Entity Subtype: WEAPON/WEAPON SYSTEM/MISSILE LAUNCHER Symbol Set Code: 15 Code: 111002 Icon Type: Full Octagon</p>		<p>N/A</p>
<p>MISSILE LAUNCHER – HEAVY</p> <p>Entity/Entity Subtype: WEAPON/WEAPON SYSTEM/MISSILE LAUNCHER Symbol Set Code: 15 Code: 111003 Icon Type: Full Octagon</p>		<p>N/A</p>
<p>AIR DEFENSE MISSILE LAUNCHER</p> <p>Type: Entity Type Entity: WEAPON/WEAPON SYSTEM Symbol Set Code: 15 Code: 111100 Icon Type: Full Octagon</p>		<p>N/A</p>
<p>AIR DEFENSE MISSILE LAUNCHER – LIGHT</p> <p>Type: Entity Subtype Entity/Entity Type: WEAPON/WEAPON SYSTEM/ AIR DEFENSE MISSILE LAUNCHER Symbol Set Code: 15 Code: 111101 Icon Type: Full Octagon</p>		<p>N/A</p>
<p>AIR DEFENSE MISSILE LAUNCHER – LIGHT, TLAR</p> <p>Type: Entity Subtype Entity/Entity Type: WEAPON/WEAPON SYSTEM/ AIR DEFENSE MISSILE LAUNCHER Symbol Set Code: 15 Code: 111102 Icon Type: Full Octagon</p>		<p>N/A</p>

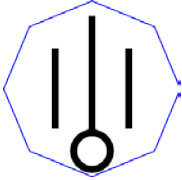
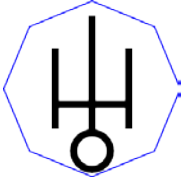
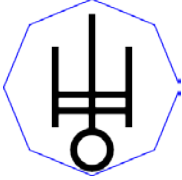
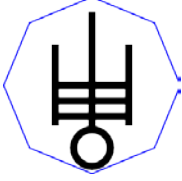
TABLE D-XI. Land equipment icons - Continued.



DESCRIPTION	ICON	REMARKS
<p>AIR DEFENSE MISSILE LAUNCHER – LIGHT, TELAR</p> <p>Type: Entity Subtype Entity/Entity Type: WEAPON/WEAPON SYSTEM/ AIR DEFENSE MISSILE LAUNCHER Symbol Set Code: 15 Code: 111103 Icon Type: Full Octagon</p>		<p>N/A</p>
<p>AIR DEFENSE MISSILE LAUNCHER – MEDIUM</p> <p>Type: Entity Subtype Entity/Entity Type: WEAPON/WEAPON SYSTEM/AIR DEFENSE MISSILE LAUNCHER Symbol Set Code: 15 Code: 111104 Icon Type: Full Octagon</p>		<p>N/A</p>
<p>AIR DEFENSE MISSILE LAUNCHER – MEDIUM, TLAR</p> <p>Type: Entity Subtype Entity/Entity Type: WEAPON/WEAPON SYSTEM/ AIR DEFENSE MISSILE LAUNCHER Symbol Set Code: 15 Code: 111105 Icon Type: Full Octagon</p>		<p>N/A</p>
<p>AIR DEFENSE MISSILE LAUNCHER – MEDIUM, TELAR</p> <p>Type: Entity Subtype Entity/Entity Type: WEAPON/WEAPON SYSTEM/ AIR DEFENSE MISSILE LAUNCHER Symbol Set Code: 15 Code: 111106 Icon Type: Full Octagon</p>		<p>N/A</p>

TABLE D-XI. Land equipment icons - Continued.

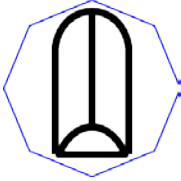
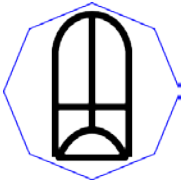
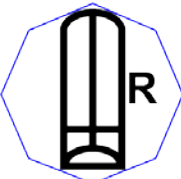
DESCRIPTION	ICON	REMARKS
<p>AIR DEFENSE MISSILE LAUNCHER – HEAVY</p> <p>Type: Entity Subtype Entity/Entity Type: WEAPON/WEAPON SYSTEM/ AIR DEFENSE MISSILE LAUNCHER Symbol Set Code: 15 Code: 111107 Icon Type: Full Octagon</p>		<p>N/A</p>
<p>AIR DEFENSE MISSILE LAUNCHER – HEAVY, TLAR</p> <p>Type: Entity Subtype Entity/Entity Type: WEAPON/WEAPON SYSTEM/ AIR DEFENSE MISSILE LAUNCHER Symbol Set Code: 15 Code: 111108 Icon Type: Full Octagon</p>		<p>N/A</p>
<p>AIR DEFENSE MISSILE LAUNCHER – HEAVY, TELAR</p> <p>Type: Entity Subtype Entity/Entity Type: WEAPON/WEAPON SYSTEM/ AIR DEFENSE MISSILE LAUNCHER Symbol Set Code: 15 Code: 111109 Icon Type: Full Octagon</p>		<p>N/A</p>
<p>ANTITANK MISSILE LAUNCHER</p> <p>Type: Entity Type Entity: WEAPON/WEAPON SYSTEM Symbol Set Code: 15 Code: 111200 Icon Type: Full Octagon</p>		<p>N/A</p>
<p>ANTITANK MISSILE LAUNCHER – LIGHT</p> <p>Type: Entity Subtype Entity/Entity Type: WEAPON/WEAPON SYSTEM/ANTITANK MISSILE LAUNCHER Symbol Set Code: 15 Code: 111201 Icon Type: Full Octagon</p>		<p>N/A</p>

TABLE D-XI. Land equipment icons - Continued.

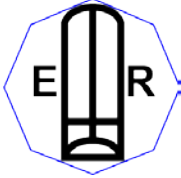
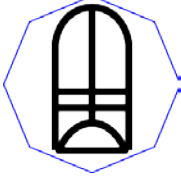
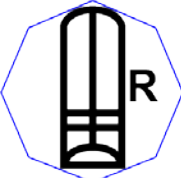
DESCRIPTION	ICON	REMARKS
<p>ANTITANK MISSILE LAUNCHER – MEDIUM</p> <p>Type: Entity Subtype Entity/Entity Type: WEAPON/WEAPON SYSTEM/ ANTITANK MISSILE LAUNCHER Symbol Set Code: 15 Code: 111202 Icon Type: Full Octagon</p>		<p>N/A</p>
<p>ANTITANK MISSILE LAUNCHER – HEAVY</p> <p>Type: Entity Subtype Entity/Entity Type: WEAPON/WEAPON SYSTEM/ ANTITANK MISSILE LAUNCHER Symbol Set Code: 15 Code: 111203 Icon Type: Full Octagon</p>		<p>N/A</p>
<p>SURFACE-TO-SURFACE MISSILE LAUNCHER</p> <p>Type: Entity Type Entity/Entity Type: WEAPON/WEAPON SYSTEM Symbol Set Code: 15 Code: 111300 Icon Type: Full Octagon</p>		<p>N/A</p>
<p>SURFACE-TO-SURFACE MISSILE LAUNCHER – LIGHT</p> <p>Type: Entity Subtype Entity/Entity Type: WEAPON/WEAPON SYSTEM/SURFACE TO SURFACE MISSILE LAUNCHER Symbol Set Code: 15 Code: 111301 Icon Type: Full Octagon</p>		<p>N/A</p>
<p>SURFACE-TO-SURFACE MISSILE LAUNCHER – MEDIUM</p> <p>Type: Entity Subtype Entity/Entity Type: WEAPON/WEAPON SYSTEM/ SURFACE TO SURFACE MISSILE LAUNCHER Symbol Set Code: 15 Code: 111302 Icon Type: Full Octagon</p>		<p>N/A</p>

TABLE D-XI. Land equipment icons - Continued.

DESCRIPTION	ICON	REMARKS
<p>SURFACE-TO-SURFACE MISSILE LAUNCHER – HEAVY</p> <p>Type: Entity Subtype Entity/Entity Type: WEAPON/WEAPON SYSTEM/SURFACE TO SURFACE MISSILE LAUNCHER Symbol Set Code: 15 Code: 111303 Icon Type: Full Octagon</p>		<p>N/A</p>
<p>MORTAR</p> <p>Type: Entity Type Entity: WEAPON/WEAPON SYSTEM Symbol Set Code: 15 Code: 111400 Icon Type: Full Octagon</p>		<p>N/A</p>
<p>MORTAR – LIGHT</p> <p>Type: Entity Type Entity/Entity Type: WEAPON/WEAPON SYSTEM/MORTAR Symbol Set Code: 15 Code: 111401 Icon Type: Full Octagon</p>		<p>N/A</p>
<p>MORTAR – MEDIUM</p> <p>Type: Entity Type Entity/Entity Type: WEAPON/WEAPON SYSTEM/MORTAR Symbol Set Code: 15 Code: 111402 Icon Type: Full Octagon</p>		<p>N/A</p>
<p>MORTAR – HEAVY</p> <p>Type: Entity Type Entity/Entity Type: WEAPON/WEAPON SYSTEM/MORTAR Symbol Set Code: 15 Code: 111403 Icon Type: Full Octagon</p>		<p>N/A</p>

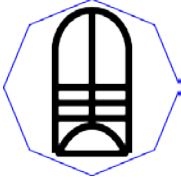
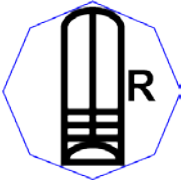
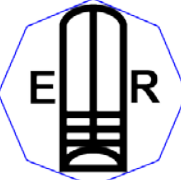
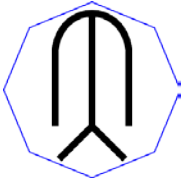
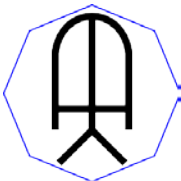
TABLE D-XI. Land equipment icons - Continued.

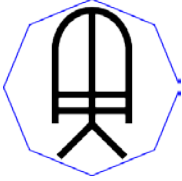
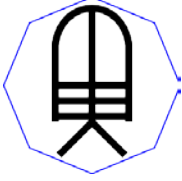
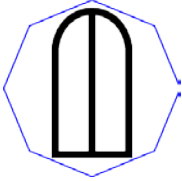
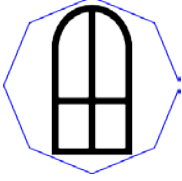
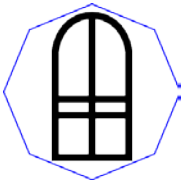

DESCRIPTION	ICON	REMARKS
<p>SINGLE ROCKET LAUNCHER</p> <p>Type: Entity Type Entity: WEAPON/WEAPON SYSTEM Symbol Set Code: 15 Code: 111500 Icon Type: Full Octagon</p>		<p>N/A</p>
<p>SINGLE ROCKET LAUNCHER – LIGHT</p> <p>Type: Entity Subtype Entity/Entity Type: WEAPON/WEAPON SYSTEM/SINGLE ROCKET LAUNCHER Symbol Set Code: 15 Code: 111501 Icon Type: Full Octagon</p>		<p>N/A</p>
<p>SINGLE ROCKET LAUNCHER – MEDIUM</p> <p>Type: Entity Subtype Entity/Entity Type: WEAPON/WEAPON SYSTEM/SINGLE ROCKET LAUNCHER Symbol Set Code: 15 Code: 111502 Icon Type: Full Octagon</p>		<p>N/A</p>
<p>SINGLE ROCKET LAUNCHER – HEAVY</p> <p>Type: Entity Subtype Entity/Entity Type: WEAPON/WEAPON SYSTEM/SINGLE ROCKET LAUNCHER Symbol Set Code: 15 Code: 111503 Icon Type: Full Octagon</p>		<p>N/A</p>
<p>MULTIPLE ROCKET LAUNCHER</p> <p>Type: Entity Type Entity: WEAPON/WEAPON SYSTEM Symbol Set Code: 15 Code: 111600 Icon Type: Full Octagon</p>		<p>N/A</p>

TABLE D-XI. Land equipment icons - Continued.

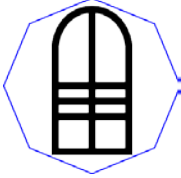
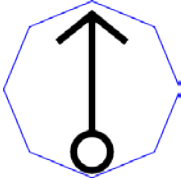
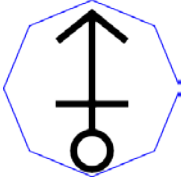
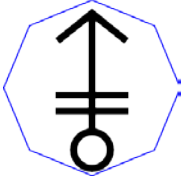
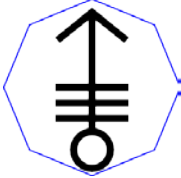

DESCRIPTION	ICON	REMARKS
<p>MULTIPLE ROCKET LAUNCHER – LIGHT</p> <p>Type: Entity Subtype Entity/Entity Type: WEAPON/WEAPON SYSTEM/MULTIPLE ROCKET LAUNCHER Symbol Set Code: 15 Code: 111601 Icon Type: Full Octagon</p>		<p>N/A</p>
<p>MULTIPLE ROCKET LAUNCHER – MEDIUM</p> <p>Type: Entity Subtype Entity/Entity Type: WEAPON/WEAPON SYSTEM/MULTIPLE ROCKET LAUNCHER Symbol Set Code: 15 Code: 111602 Icon Type: Full Octagon</p>		<p>N/A</p>
<p>MULTIPLE ROCKET LAUNCHER/ – HEAVY</p> <p>Type: Entity Subtype Entity/Entity Type: WEAPON/WEAPON SYSTEM/MULTIPLE ROCKET LAUNCHER Symbol Set Code: 15 Code: 111603 Icon Type: Full Octagon</p>		<p>N/A</p>
<p>ANTITANK ROCKET LAUNCHER</p> <p>Type: Entity Type Entity: WEAPON/WEAPON SYSTEM Symbol Set Code: 15 Code: 111700 Icon Type: Full Octagon</p>		<p>N/A</p>

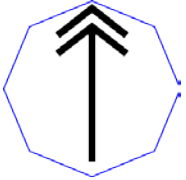
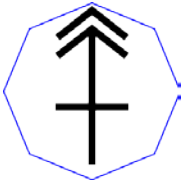
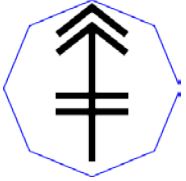
TABLE D-XI. Land equipment icons - Continued.

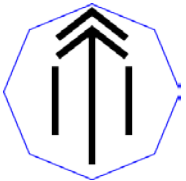

DESCRIPTION	ICON	REMARKS
<p>ANTITANK ROCKET LAUNCHER – LIGHT</p> <p>Type: Entity Subtype Entity/Entity Type: WEAPON/WEAPON SYSTEM/ANTITANK ROCKET LAUNCHER Symbol Set Code: 15 Code: 111701 Icon Type: Full Octagon</p>		<p>N/A</p>
<p>ANTITANK ROCKET LAUNCHER – MEDIUM</p> <p>Type: Entity Subtype Entity/Entity Type: WEAPON/WEAPON SYSTEM/ANTITANK ROCKET LAUNCHER Symbol Set Code: 15 Code: 111702 Icon Type: Full Octagon</p>		<p>N/A</p>
<p>ANTITANK ROCKET LAUNCHER – HEAVY</p> <p>Type: Entity Subtype Entity/Entity Type: WEAPON/WEAPON SYSTEM/ANTITANK ROCKET LAUNCHER Symbol Set Code: 15 Code: 111703 Icon Type: Full Octagon</p>		<p>N/A</p>
<p>NONLETHAL WEAPON</p> <p>Type: Entity Type Entity: WEAPON/WEAPON SYSTEM Symbol Set Code: 15 Code: 111800 Icon Type: Full Octagon</p>		<p>N/A</p>
<p>TASER</p> <p>Type: Entity Type Entity: WEAPON/WEAPON SYSTEM Symbol Set Code: 15 Code: 111900 Icon Type: Full Octagon</p>		<p>N/A</p>

TABLE D-XI. Land equipment icons - Continued.

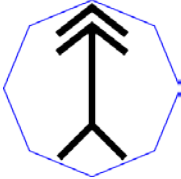

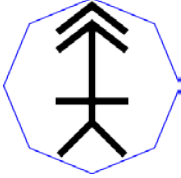
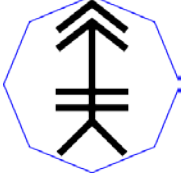

DESCRIPTION	ICON	REMARKS
WATER CANNON Type: Entity Type Entity: WEAPON/WEAPON SYSTEM Symbol Set Code: 15 Code: 112000 Icon Type: Full Octagon		N/A
VEHICLE Type: Entity Symbol Set Code: 15 Code: 120000 Icon Type: Full Octagon		This symbol shall not be displayed on a C2 system but may be displayed for training or hierarchal explanation purposes.
ARMORED Type: Entity Type Entity: VEHICLE Symbol Set Code: 15 Code: 120100 Icon Type: Full Octagon		N/A
ARMORED FIGHTING VEHICLE Type: Entity Subtype Entity/Entity Type: VEHICLE/ARMORED Symbol Set Code: 15 Code: 120101 Icon Type: Full Octagon		N/A
ARMORED FIGHTING VEHICLE COMMAND AND CONTROL Type: Entity Subtype Entity/Entity Type: VEHICLE/ARMORED Symbol Set Code: 15 Code: 120102 Icon Type: Full Octagon		N/A
ARMORED PERSONNEL CARRIER Type: Entity Subtype Entity/Entity Type: VEHICLE/ARMORED Symbol Set Code: 15 Code: 120103 Icon Type: Full Octagon		N/A

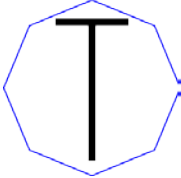
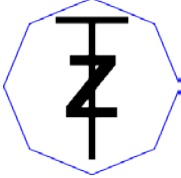
TABLE D-XI. Land equipment icons - Continued.

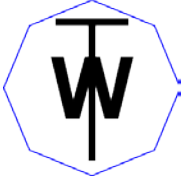
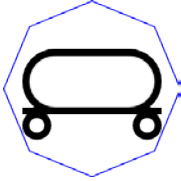

DESCRIPTION	ICON	REMARKS
<p>ARMORED PERSONNEL CARRIER AMBULANCE</p> <p>Type: Entity Subtype Entity/Entity Type: VEHICLE/ARMORED Symbol Set Code: 15 Code: 120104 Icon Type: Full Octagon</p>		<p>N/A</p>
<p>ARMORED PROTECTED VEHICLE</p> <p>Type: Entity Subtype Entity/Entity Type: VEHICLE/ARMORED Symbol Set Code: 15 Code: 120105 Icon Type: Main</p>		<p>N/A</p>
<p>ARMORED PROTECTED VEHICLE RECOVERY</p> <p>Type: Entity Subtype Entity/Entity Type: VEHICLE/ARMORED Symbol Set Code: 15 Code: 120106 Icon Type: Main</p>		<p>N/A</p>
<p>ARMORED PROTECTED VEHICLE MEDICAL EVACUATION</p> <p>Type: Entity Subtype Entity/Entity Type: VEHICLE/ARMORED Symbol Set Code: 15 Code: 120107 Icon Type: Main</p>		<p>N/A</p>
<p>ARMORED PERSONNEL CARRIER, RECOVERY</p> <p>Type: Entity Subtype Entity/Entity Type: VEHICLE/ARMORED Symbol Set Code: 15 Code: 120108 Icon Type: Full Octagon</p>		<p>N/A</p>

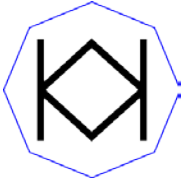
TABLE D-XI. Land equipment icons - Continued.

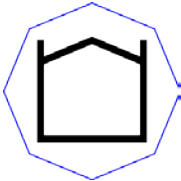

DESCRIPTION	ICON	REMARKS
COMBAT SERVICE SUPPORT VEHICLE Type: Entity Subtype Entity/Entity Type: VEHICLE/ARMORED Symbol Set Code: 15 Code: 120109 Icon Type: Full Octagon		N/A
LIGHT WHEELED ARMORED VEHICLE Type: Entity Subtype Entity/Entity Type: VEHICLE/ARMORED Symbol Set Code: 15 Code: 120110 Icon Type: Full Octagon		N/A
TANK Type: Entity Type Entity: VEHICLE Symbol Set Code: 15 Code: 120200 Icon Type: Full Octagon		N/A
TANK - LIGHT Type: Entity Subtype Entity/Entity Type: VEHICLE/TANK Symbol Set Code: 15 Code: 120201 Icon Type: Full Octagon		N/A
TANK - MEDIUM Type: Entity Subtype Entity/Entity Type: VEHICLE/TANK Symbol Set Code: 15 Code: 120202 Icon Type: Full Octagon		N/A
TANK - HEAVY Type: Entity Subtype Entity/Entity Type: VEHICLE/TANK Symbol Set Code: 15 Code: 120203 Icon Type: Full Octagon		N/A

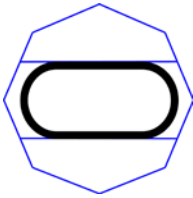
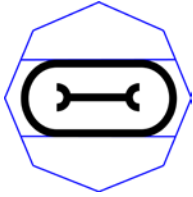
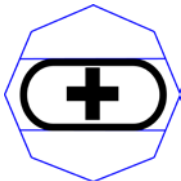
TABLE D-XI. Land equipment icons - Continued.



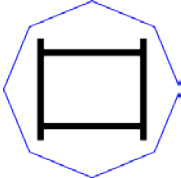
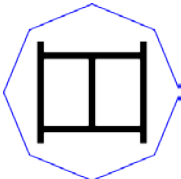
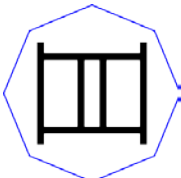
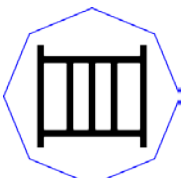

DESCRIPTION	ICON	REMARKS
<p>TANK RECOVERY VEHICLE</p> <p>Type: Entity Type Entity: VEHICLE Symbol Set Code: 15 Code: 120300 Icon Type: Full Octagon</p>		N/A
<p>TANK RECOVERY VEHICLE – LIGHT</p> <p>Type: Entity Subtype Entity/Entity Type: VEHICLE/TANK RECOVERY VEHICLE Symbol Set Code: 15 Code: 120301 Icon Type: Full Octagon</p>		N/A
<p>TANK RECOVERY VEHICLE – MEDIUM</p> <p>Type: Entity Subtype Entity/Entity Type: VEHICLE/TANK/ RECOVERY VEHICLE/ Symbol Set Code: 15 Code: 120302 Icon Type: Full Octagon</p>		N/A
<p>TANK RECOVERY VEHICLE - HEAVY</p> <p>Type: Entity Subtype Entity/Entity Type: VEHICLE/TANK RECOVERY VEHICLE Symbol Set Code: 15 Code: 120303 Icon Type: Full Octagon</p>		N/A
<p>ENGINEER VEHICLES AND EQUIPMENT</p> <p>Type: Entity Symbol Set Code: 15 Code: 130000 Icon Type: Full Octagon</p>		N/A
<p>BRIDGE</p> <p>Type: Entity Type Entity: ENGINEER VEHICLES AND EQUIPMENT Symbol Set Code: 15 Code: 130100 Icon Type: Full Octagon</p>		N/A

TABLE D-XI. Land equipment icons - Continued.

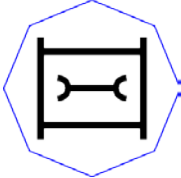
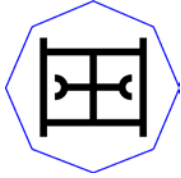

DESCRIPTION	ICON	REMARKS
<p>BRIDGE MOUNTED ON UTILITY VEHICLE</p> <p>Type: Entity Type Entity/Entity Type: ENGINEER VEHICLES AND EQUIPMENT Symbol Set Code: 15 Code: 130200 Icon Type: Full Octagon</p>		N/A
<p>FIXED BRIDGE</p> <p>Type: Entity Type Entity/Entity Type: ENGINEER VEHICLES AND EQUIPMENT Symbol Set Code: 15 Code: 130300 Icon Type: Full Octagon</p>		N/A
<p>FLOATING BRIDGE</p> <p>Type: Entity Type Entity/Entity Type: ENGINEER VEHICLES AND EQUIPMENT Symbol Set Code: 15 Code: 130400 Icon Type: Full Octagon</p>		N/A
<p>FOLDING GIRDER BRIDGE</p> <p>Type: Entity Type Entity/Entity Type: ENGINEER VEHICLES AND EQUIPMENT Symbol Set Code: 15 Code: 130500 Icon Type: Full Octagon</p>		N/A
<p>HOLLOW DECK BRIDGE</p> <p>Type: Entity Type Entity/Entity Type: ENGINEER VEHICLES AND EQUIPMENT Symbol Set Code: 15 Code: 130600 Icon Type: Full Octagon</p>		N/A
<p>DRILL</p> <p>Type: Entity Type Entity/Entity Type: ENGINEER VEHICLES AND EQUIPMENT Symbol Set Code: 15 Code: 130700 Icon Type: Full Octagon</p>		N/A

TABLE D-XI. Land equipment icons - Continued.

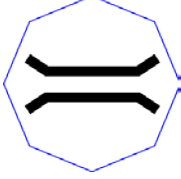

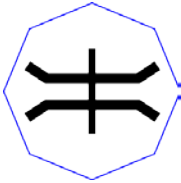

DESCRIPTION	ICON	REMARKS
DRILL MOUNTED ON UTILITY VEHICLE Type: Entity Type Entity/Entity Type: ENGINEER VEHICLES AND EQUIPMENT/DRILL Symbol Set Code: 15 Code: 130701 Icon Type: Full Octagon		N/A
EARTHMOVER Type: Entity Type Entity/Entity Type: ENGINEER VEHICLES AND EQUIPMENT Symbol Set Code: 15 Code: 130800 Icon Type: Full Octagon		N/A
MULTIFUNCTIONAL EARTHMOVER/DIGGER Type: Entity Type Entity/Entity Type: ENGINEER VEHICLES AND EQUIPMENT/EARTHMOVER Symbol Set Code: 15 Code: 130801 Icon Type: Full Octagon		N/A
MINE CLEARING EQUIPMENT Type: Entity Type Entity/Entity Type: ENGINEER VEHICLES AND EQUIPMENT Symbol Set Code: 15 Code: 130900 Icon Type: Full Octagon		N/A
MINE CLEARING EQUIPMENT, TRAILER MOUNTED Type: Entity Subtype Entity/Entity Type: ENGINEER VEHICLES AND EQUIPMENT/MINE CLEARING EQUIPMENT Symbol Set Code: 15 Code: 130901 Icon Type: Full Octagon		N/A

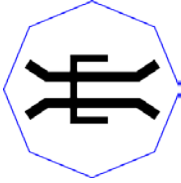
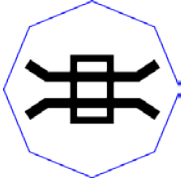
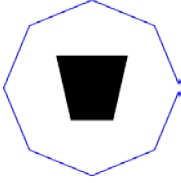
TABLE D-XI. Land equipment icons - Continued.



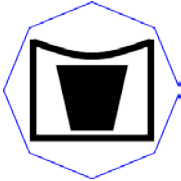
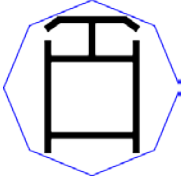

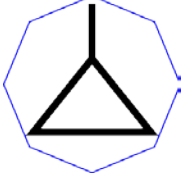
DESCRIPTION	ICON	REMARKS
<p>MINE CLEARING EQUIPMENT ON TANK CHASSIS</p> <p>Type: Entity Type Entity/Entity Type: ENGINEER VEHICLES AND EQUIPMENT/ MINE CLEARING EQUIPMENT Symbol Set Code: 15 Code: 130902 Icon Type: Full Octagon</p>		N/A
<p>MINE LAYING EQUIPMENT</p> <p>Type: Entity Type Entity/Entity Type: ENGINEER VEHICLES AND EQUIPMENT/ MINE LAYING EQUIPMENT Symbol Set Code: 15 Code: 131000 Icon Type: Full Octagon</p>		N/A
<p>MINE LAYING EQUIPMENT ON UTILITY VEHICLE</p> <p>Type: Entity Type Entity/Entity Type: ENGINEER VEHICLES AND EQUIPMENT/ MINE LAYING EQUIPMENT Symbol Set Code: 15 Code: 131001 Icon Type: Full Octagon</p>		N/A
<p>ARMORED CARRIER WITH VOLCANO</p> <p>Type: Entity Subtype Entity/Entity Type: ENGINEER VEHICLES AND EQUIPMENT/ MINE LAYING EQUIPMENT Symbol Set Code: 15 Code: 131002 Icon Type: Full Octagon</p>		N/A
<p>TRUCK MOUNTED WITH VOLCANO</p> <p>Type: Entity Subtype Entity/Entity Type: ENGINEER VEHICLES AND EQUIPMENT/ MINE LAYING EQUIPMENT Symbol Set Code: 15 Code: 131003 Icon Type: Full Octagon</p>		N/A

TABLE D-XI. Land equipment icons - Continued.



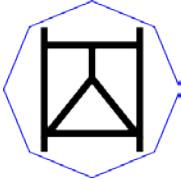
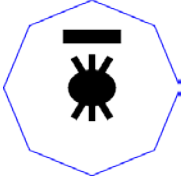

DESCRIPTION	ICON	REMARKS
<p>DOZER</p> <p>Type: Entity Type Entity/Entity Type: ENGINEER VEHICLES AND EQUIPMENT Symbol Set Code: 15 Code: 131100 Icon Type: Full Octagon</p>		N/A
<p>DOZER, ARMORED</p> <p>Type: Entity Subtype Entity/Entity Type: ENGINEER VEHICLES AND EQUIPMENT/DOZER Symbol Set Code: 15 Code: 131101 Icon Type: Full Octagon</p>		N/A
<p>ARMORED ASSAULT</p> <p>Type: Entity Type Entity/Entity Type: ENGINEER VEHICLES AND EQUIPMENT Symbol Set Code: 15 Code: 131200 Icon Type: Full Octagon</p>		N/A
<p>ARMORED ENGINEER RECON VEHICLE (AERV)</p> <p>Type: Entity Type Entity/Entity Type: ENGINEER VEHICLES AND EQUIPMENT Symbol Set Code: 15 Code: 131300 Icon Type: Full Octagon</p>		N/A
<p>BACKHOE</p> <p>Type: Entity Type Entity/Entity Type: ENGINEER VEHICLES AND EQUIPMENT Symbol Set Code: 15 Code: 131400 Icon Type: Full Octagon</p>		N/A
<p>CONSTRUCTION VEHICLE</p> <p>Type: Entity Type Entity/Entity Type: ENGINEER VEHICLES AND EQUIPMENT Symbol Set Code: 15 Code: 131500 Icon Type: Full Octagon</p>		N/A

TABLE D-XI. Land equipment icons - Continued.

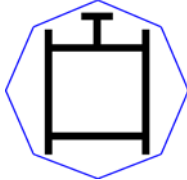
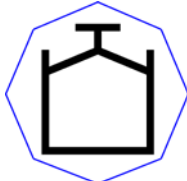

DESCRIPTION	ICON	REMARKS
<p>FERRY TRANSPORTER</p> <p>Type: Entity Type Entity/Entity Type: ENGINEER VEHICLES AND EQUIPMENT Symbol Set Code: 15 Code: 131600 Icon Type: Full Octagon</p>		<p>N/A</p>
<p>UTILITY VEHICLE</p> <p>Type: Entity Symbol Set Code: 15 Code: 140000</p>	<p>N/A</p>	<p>No icon is associated with this entity. It is for hierarchal purposes only.</p>
<p>UTILITY</p> <p>Type: Entity Type Entity: UTILITY VEHICLE Symbol Set Code: 15 Code: 140100 Icon Type: Full Octagon</p>		<p>N/A</p>
<p>MEDICAL</p> <p>Type: Entity Type Entity: UTILITY VEHICLE Symbol Set Code: 15 Code: 140200 Icon Type: Full Octagon</p>		<p>N/A</p>
<p>MEDICAL EVACUATION (MEDEVAC)</p> <p>Type: Entity Type Entity: UTILITY VEHICLE Symbol Set Code: 15 Code: 140300 Icon Type: Full Octagon</p>		<p>N/A</p>
<p>MOBILE EMERGENCY PHYSICIAN</p> <p>Type: Entity Type Entity: UTILITY VEHICLE Symbol Set Code: 15 Code: 140400 Icon Type: Full Octagon</p>		<p>N/A</p>
<p>BUS</p> <p>Type: Entity Type Entity: UTILITY VEHICLE Symbol Set Code: 15 Code: 140500 Icon Type: Full Octagon</p>		<p>N/A</p>

TABLE D-XI. Land equipment icons - Continued.



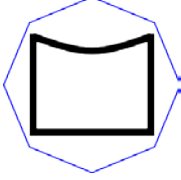
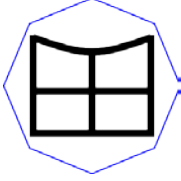

DESCRIPTION	ICON	REMARKS
SEMI-TRAILER AND TRUCK Type: Entity Type Entity: UTILITY VEHICLE Symbol Set Code: 15 Code: 140600 Icon Type: Full Octagon		N/A
SEMI-TRAILER AND TRUCK - LIGHT Type: Entity Subtype Entity/Entity Type: UTILITY VEHICLE/SEMI-TRAILER AND TRUCK Symbol Set Code: 15 Code: 140601 Icon Type: Full Octagon		N/A
SEMI-TRAILER AND TRUCK - MEDIUM Type: Entity Subtype Entity/Entity Type: UTILITY VEHICLE/SEMI-TRAILER AND TRUCK Symbol Set Code: 15 Code: 140602 Icon Type: Full Octagon		N/A
SEMI-TRAILER AND TRUCK - HEAVY Type: Entity Subtype Entity/Entity Type: UTILITY VEHICLE/SEMI-TRAILER AND TRUCK Symbol Set Code: 15 Code: 140603 Icon Type: Full Octagon		N/A
LIMITED CROSS-COUNTRY TRUCK Type: Entity Type Entity: UTILITY VEHICLE Symbol Set Code: 15 Code: 140700 Icon Type: Full Octagon		N/A

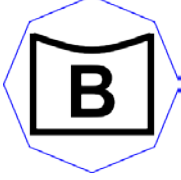
TABLE D-XI. Land equipment icons - Continued.





DESCRIPTION	ICON	REMARKS
CROSS-COUNTRY TRUCK Type: Entity Type Entity: UTILITY VEHICLE Symbol Set Code: 15 Code: 140800 Icon Type: Full Octagon		N/A
PETROLEUM, OIL AND LUBRICANT Type: Entity Type Entity: UTILITY VEHICLE Symbol Set Code: 15 Code: 140900 Icon Type: Full Octagon		N/A
WATER Type: Entity Type Entity: UTILITY VEHICLE Symbol Set Code: 15 Code: 141000 Icon Type: Full Octagon		N/A
AMPHIBIOUS UTILITY WHEELED VEHICLE Type: Entity Type Entity: UTILITY VEHICLE Symbol Set Code: 15 Code: 141100 Icon Type: Full Octagon		N/A
TOW TRUCK Type: Entity Type Entity: UTILITY VEHICLE Symbol Set Code: 15 Code: 141200 Icon Type: Full Octagon		N/A
TOW TRUCK, LIGHT Type: Entity Subtype Entity/ Entity Type: UTILITY VEHICLE/TOW TRUCK Symbol Set Code: 15 Code: 141201 Icon Type: Full Octagon		N/A

TABLE D-XI. Land equipment icons - Continued.

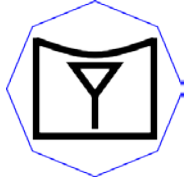

DESCRIPTION	ICON	REMARKS
TOW TRUCK, HEAVY Type: Entity Subtype Entity/ Entity Type: UTILITY VEHICLE/TOW TRUCK Symbol Set Code: 15 Code: 141202 Icon Type: Full Octagon		N/A
TRAIN Type: Entity Type Symbol Set Code: 15 Code: 150000	N/A	No icon is associated with this entity. It is for hierarchal purposes only.
LOCOMOTIVE Type: Entity Type Entity: TRAIN Symbol Set Code: 15 Code: 150100 Icon Type: Full Octagon		N/A
RAILCAR Type: Entity Type Entity: TRAIN Symbol Set Code: 15 Code: 150200 Icon Type: Full Octagon		N/A
CIVILIAN VEHICLE Type: Entity Symbol Set Code: 15 Code: 160000	N/A	No icon is associated with this entity. It is for hierarchal purposes only.
AUTOMOBILE Type: Entity Type Entity: CIVILIAN VEHICLE Symbol Set Code: 15 Code: 160100 Icon Type: Full Octagon		N/A
COMPACT Type: Entity Subtype Entity/Entity Type: CIVILIAN VEHICLE/AUTOMOBILE Symbol Set Code: 15 Code: 160101 Icon Type: Full Octagon		N/A

TABLE D-XI. Land equipment icons - Continued.





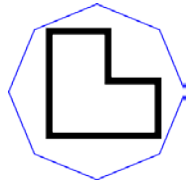
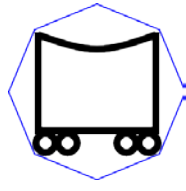

DESCRIPTION	ICON	REMARKS
MIDSIZE Type: Entity Subtype Entity/Entity Type: CIVILIAN VEHICLE/AUTOMOBILE Symbol Set Code: 15 Code: 160102 Icon Type: Full Octagon		N/A
SEDAN Type: Entity Subtype Entity/Entity Type: CIVILIAN VEHICLE/AUTOMOBILE Symbol Set Code: 15 Code: 160103 Icon Type: Full Octagon		N/A
OPEN-BED TRUCK Type: Entity Type Entity: CIVILIAN VEHICLE Symbol Set Code: 15 Code: 160200 Icon Type: Full Octagon		N/A
PICKUP Type: Entity Subtype Entity/Entity Type: CIVILIAN VEHICLE/ OPEN-BED TRUCK Symbol Set Code: 15 Code: 160201 Icon Type: Full Octagon		N/A
SMALL Type: Entity Subtype Entity/Entity Type: CIVILIAN VEHICLE/ OPEN-BED TRUCK Symbol Set Code: 15 Code: 160202 Icon Type: Full Octagon		N/A
LARGE Type: Entity Subtype Entity/Entity Type: CIVILIAN VEHICLE/OPEN-BED TRUCK Symbol Set Code: 15 Code: 160203 Icon Type: Full Octagon		N/A

TABLE D-XI. Land equipment icons - Continued.







DESCRIPTION	ICON	REMARKS
MULTIPLE PASSENGER VEHICLE Type: Entity Type Entity: CIVILIAN VEHICLE Symbol Set Code: 15 Code: 160300 Icon Type: Full Octagon		N/A
VAN Type: Entity Subtype Entity/Entity Type: CIVILIAN VEHICLE/MULTIPLE PASSENGER VEHICLE Symbol Set Code: 15 Code: 160301 Icon Type: Full Octagon		N/A
SMALL BUS Type: Entity Subtype Entity/Entity Type: CIVILIAN VEHICLE/MULTIPLE PASSENGER VEHICLE Symbol Set Code: 15 Code: 160302 Icon Type: Full Octagon		N/A
LARGE BUS Type: Entity Subtype Entity/Entity Type: CIVILIAN VEHICLE/MULTIPLE PASSENGER VEHICLE Symbol Set Code: 15 Code: 160303 Icon Type: Full Octagon		N/A
UTILITY VEHICLE Type: Entity Type Entity: CIVILIAN VEHICLE Symbol Set Code: 15 Code: 160400 Icon Type: Full Octagon		N/A
SPORT UTILITY VEHICLE (SUV) Type: Entity Subtype Entity/Entity Type: CIVILIAN VEHICLE/ UTILITY VEHICLE Symbol Set Code: 15 Code: 160401 Icon Type: Full Octagon		N/A

TABLE D-XI. Land equipment icons - Continued.







DESCRIPTION	ICON	REMARKS
SMALL BOX TRUCK Type: Entity Subtype Entity/Entity Type: CIVILIAN VEHICLE/ UTILITY VEHICLE Symbol Set Code: 15 Code: 160402 Icon Type: Full Octagon		N/A
LARGE BOX TRUCK Type: Entity Subtype Entity/Entity Type: CIVILIAN VEHICLE/ UTILITY VEHICLE Symbol Set Code: 15 Code: 160403 Icon Type: Full Octagon		N/A
JEEP TYPE VEHICLE Type: Entity Type Entity: CIVILIAN VEHICLE Symbol Set Code: 15 Code: 160500 Icon Type: Full Octagon		N/A
SMALL/LIGHT Type: Entity Subtype Entity/Entity Type: CIVILIAN VEHICLE/ JEEP TYPE VEHICLE Symbol Set Code: 15 Code: 160501 Icon Type: Full Octagon		N/A
MEDIUM Type: Entity Subtype Entity/Entity Type: CIVILIAN VEHICLE/ JEEP TYPE VEHICLE Symbol Set Code: 15 Code: 160502 Icon Type: Full Octagon		N/A
LARGE/HEAVY Type: Entity Subtype Entity/Entity Type: CIVILIAN VEHICLE/ JEEP TYPE VEHICLE Symbol Set Code: 15 Code: 160503 Icon Type: Full Octagon		N/A

TABLE D-XI. Land equipment icons - Continued.





DESCRIPTION	ICON	REMARKS
<p>TRACTOR TRAILER TRUCK WITH BOX</p> <p>Type: Entity Type Entity: CIVILIAN VEHICLE Symbol Set Code: 15 Code: 160600 Icon Type: Full Octagon</p>		N/A
<p>SMALL/LIGHT BOX TRAILER</p> <p>Type: Entity Subtype Entity/Entity Type: CIVILIAN VEHICLE/ TRACTOR TRAILER TRUCK WITH BOX Symbol Set Code: 15 Code: 160601 Icon Type: Full Octagon</p>		N/A
<p>MEDIUM BOX TRAILER</p> <p>Type: Entity Subtype Entity/Entity Type: CIVILIAN VEHICLE/ TRACTOR TRAILER TRUCK WITH BOX Symbol Set Code: 15 Code: 160602 Icon Type: Full Octagon</p>		N/A
<p>LARGE/HEAVY BOX TRAILER</p> <p>Type: Entity Subtype Entity/Entity Type: CIVILIAN VEHICLE/TRACTOR TRAILER TRUCK WITH BOX TRAILER Symbol Set Code: 15 Code: 160603 Icon Type: Full Octagon</p>		N/A
<p>TRACTOR TRAILER TRUCK WITH FLATBED TRAILER</p> <p>Type: Entity Type Entity: CIVILIAN VEHICLE Symbol Set Code: 15 Code: 160700 Icon Type: Full Octagon</p>		N/A

TABLE D-XI. Land equipment icons - Continued.





DESCRIPTION	ICON	REMARKS
<p>SMALL/LIGHT FLATBED TRAILER</p> <p>Type: Entity Subtype Entity/Entity Type: CIVILIAN VEHICLE/TRACTOR TRAILER TRUCK WITH FLATBED TRAILER Symbol Set Code: 15 Code: 160701 Icon Type: Full Octagon</p>		<p>N/A</p>
<p>MEDIUM FLATBED TRAILER</p> <p>Type: Entity Subtype Entity/Entity Type: CIVILIAN VEHICLE/TRACTOR TRAILER TRUCK WITH FLATBED TRAILER Symbol Set Code: 15 Code: 160702 Icon Type: Full Octagon</p>		<p>N/A</p>
<p>LARGE/HEAVY FLATBED TRAILER</p> <p>Type: Entity Subtype Entity/Entity Type: CIVILIAN VEHICLE/TRACTOR TRAILER TRUCK WITH FLATBED TRAILER Symbol Set Code: 15 Code: 160703 Icon Type: Full Octagon</p>		<p>N/A</p>
<p>KNOWN INSURGENT VEHICLE</p> <p>Type: Entity Type Entity: CIVILIAN VEHICLE Symbol Set Code: 15 Code: 160800 Icon Type: Main</p>		<p>N/A</p>
<p>DRUG VEHICLE</p> <p>Type: Entity Type Entity: CIVILIAN VEHICLE Symbol Set Code: 15 Code: 160900 Icon Type: Main</p>		<p>N/A</p>
<p>LAW ENFORCEMENT</p> <p>Type: Entity Symbol Set Code: 15 Code: 170000 Icon Type: N/A</p>		<p>N/A</p>

TABLE D-XI. Land equipment icons - Continued.





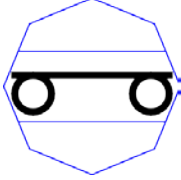

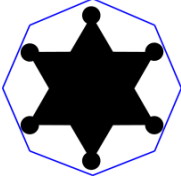
DESCRIPTION	ICON	REMARKS
BUREAU OF ALCOHOL, TOBACCO, FIREARMS AND EXPLOSIVES (ATF) (DEPARTMENT OF JUSTICE) Type: Entity Type Entity: LAW ENFORCEMENT Symbol Set Code: 15 Code: 170100 Icon Type: Main		N/A
BORDER PATROL Type: Entity Type Entity: LAW ENFORCEMENT Symbol Set Code: 15 Code: 170200 Icon Type: Full Octagon		N/A
CUSTOMS SERVICE Type: Entity Type Entity: LAW ENFORCEMENT Symbol Set Code: 15 Code: 170300 Icon Type: Full Octagon		N/A
DRUG ENFORCEMENT AGENCY (DEA) Type: Entity Type Entity: LAW ENFORCEMENT Symbol Set Code: 15 Code: 170400 Icon Type: Main		N/A
DEPARTMENT OF JUSTICE (DOJ) Type: Entity Type Entity/Entity Type: LAW ENFORCEMENT Symbol Set Code: 15 Code: 170500 Icon Type: Full Octagon		N/A
FEDERAL BUREAU OF INVESTIGATION (FBI) Type: Entity Type Entity/Entity Type LAW ENFORCEMENT Symbol Set Code: 15 Code: 170600 Icon Type: Main		N/A

TABLE D-XI. Land equipment icons - Continued.







DESCRIPTION	ICON	REMARKS
POLICE Type: Entity Type Entity/Entity Type: LAW ENFORCEMENT Symbol Set Code: 15 Code: 170700 Icon Type: Main		N/A
UNITED STATES SECRET SERVICE(TREAS) (USSS) Type: Entity Type Entity/Entity Type: LAW ENFORCEMENT Symbol Set Code: 15 Code: 170800 Icon Type: Main		N/A
TRANSPORTATION SECURITY ADMINISTRATION (TSA) Type: Entity Type Entity/Entity Type: LAW ENFORCEMENT Symbol Set Code: 15 Code: 170900 Icon Type: Main		N/A
COAST GUARD Type: Entity Type Entity/Entity Type: LAW ENFORCEMENT Symbol Set Code: 15 Code: 171000 Icon Type: Full Octagon		N/A
US MARSHALS SERVICE Type: Entity Type Entity/Entity Type: LAW ENFORCEMENT Symbol Set Code: 15 Code: 171100 Icon Type: Full Octagon		N/A
PACK ANIMALS Type: Entity Symbol Set Code: 15 Code: 180000 Icon Type: Full Octagon		N/A

TABLE D-XI. Land equipment icons - Continued.

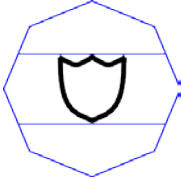



DESCRIPTION	ICON	REMARKS
MISSILE SUPPORT Type: Entity Symbol Set Code: 15 Code: 190000 Icon Type: Full Octagon		N/A
TRANSLOADER Type: Entity Type Entity: MISSILE SUPPORT Symbol Set Code: 15 Code: 190100 Icon Type: Full Octagon		N/A
TRANSPORTER Type: Entity Type Entity: MISSILE SUPPORT Symbol Set Code: 15 Code: 190200 Icon Type: Full Octagon		N/A
CRANE/LOADING DEVICE Type: Entity Type Entity: MISSILE SUPPORT Symbol Set Code: 15 Code: 190300 Icon Type: Full Octagon		N/A
PROPELLANT TRANSPORTER Type: Entity Type Entity: MISSILE SUPPORT Symbol Set Code: 15 Code: 190400 Icon Type: Full Octagon		N/A
WARHEAD TRANSPORTER Type: Entity Type Entity: MISSILE SUPPORT Symbol Set Code: 15 Code: 190500 Icon Type: Full Octagon		N/A
OTHER EQUIPMENT Type: Entity Symbol Set Code: 15 Code: 200000	N/A	No icon is associated with this entity. It is for hierarchal purposes only.

TABLE D-XI. Land equipment icons - Continued.







DESCRIPTION	ICON	REMARKS
ANTENNAE Type: Entity Type Entity: OTHER EQUIPMENT Symbol Set Code: 15 Code: 200100 Icon Type: Full Octagon		N/A
BOMB Type: Entity Type Entity: OTHER EQUIPMENT Symbol Set Code: 15 Code: 200200 Icon Type: Full Octagon		N/A
BOOBY TRAP Type: Entity Type Entity: OTHER EQUIPMENT Symbol Set Code: 15 Code: 200300 Icon Type: Full Octagon		N/A
CBRN EQUIPMENT Type: Entity Type Entity: OTHER EQUIPMENT Symbol Set Code: 15 Code: 200400 Icon Type: Full Octagon		N/A
COMPUTER SYSTEM Type: Entity Type Entity: OTHER EQUIPMENT Symbol Set Code: 15 Code: 200500 Icon Type: Full Octagon		N/A
COMMAND LAUNCH EQUIPMENT (CLE) Type: Entity Type Entity: OTHER EQUIPMENT Symbol Set Code: 15 Code: 200600 Icon Type: Main		N/A
GENERATOR SET Type: Entity Type Entity: OTHER EQUIPMENT Symbol Set Code: 15 Code: 200700 Icon Type: Full Octagon		N/A

TABLE D-XI. Land equipment icons - Continued.

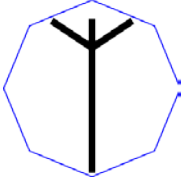

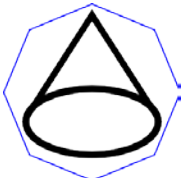
DESCRIPTION	ICON	REMARKS
GROUND-BASED MIDCOURSE DEFENSE (GMD) FIRE CONTROL (GFC) CENTER Type: Entity Type Entity: OTHER EQUIPMENT Symbol Set Code: 15 Code: 200800 Icon Type: Main		N/A
IN-FLIGHT INTERCEPTOR COMMUNICATIONS SYSTEM (IFICS) DATA TERMINAL (IDT) Type: Entity Type Entity: OTHER EQUIPMENT Symbol Set Code: 15 Code: 200900 Icon Type: Main		N/A
LASER Type: Entity Type Entity: OTHER EQUIPMENT Symbol Set Code: 15 Code: 201000 Icon Type: Full Octagon		N/A
MILITARY INFORMATION SUPPORT OPERATIONS (MISO) Type: Entity Type Entity: OTHER EQUIPMENT Symbol Set Code: 15 Code: 201100 Icon Type: Full Octagon		N/A
SUSTAINMENT SHIPMENTS Type: Entity Type Entity: OTHER EQUIPMENT Symbol Set Code: 15 Code: 201200 Icon Type: Main		N/A
TENT Type: Entity Type Entity: OTHER EQUIPMENT Symbol Set Code: 15 Code: 201300 Icon Type: Full Octagon		N/A

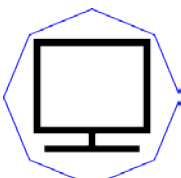
TABLE D-XI. Land equipment icons - Continued.

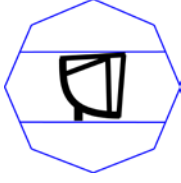
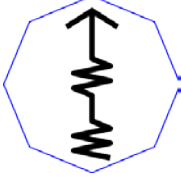
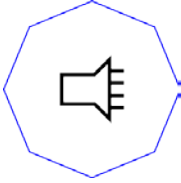

DESCRIPTION	ICON	REMARKS
UNIT DEPLOYMENT SHIPMENTS Type: Entity Type Entity: OTHER EQUIPMENT Symbol Set Code: 15 Code: 201400 Icon Type: Main		N/A
EMERGENCY MEDICAL OPERATION Type: Entity Type Entity: OTHER EQUIPMENT Symbol Set Code: 15 Code: 201500 Icon Type: Full Octagon		N/A
MEDICAL EVACUATION HELICOPTER Type: Entity Subtype Entity: OTHER EQUIPMENT/ EMERGENCY MEDICAL OPERATION Symbol Set Code: 15 Code: 201501 Icon Type: Main+1		N/A
LAND MINES Type: Entity Symbol Set Code: 15 Code: 210000	N/A	No icon is associated with this entity. It is for hierarchal purposes only.
LAND MINE Type: Entity Type Entity: LAND MINE Symbol Set Code: 15 Code: 210100 Icon Type: Full Octagon		N/A
ANTI-PERSONNEL LAND MINE (APL) Type: Entity Type Entity: LAND MINE Symbol Set Code: 15 Code: 210200 Icon Type: Full Octagon		N/A

TABLE D-XI. Land equipment icons - Continued.







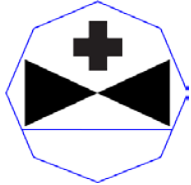
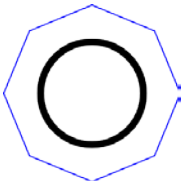
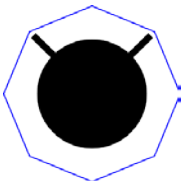

DESCRIPTION	ICON	REMARKS
<p>ANTITANK MINE</p> <p>Type: Entity Type Entity: LAND MINE Symbol Set Code: 15 Code: 210300 Icon Type: Full Octagon</p>		<p>N/A</p>
<p>IMPROVED EXPLOSIVE DEVICE (IED)</p> <p>Type: Entity Type Entity: LAND MINE Symbol Set Code: 15 Code: 210400 Icon Type: Full Octagon</p>		<p>N/A</p>
<p>LESS THAN LETHAL</p> <p>Type: Entity Type Entity: LAND MINE Symbol Set Code: 15 Code: 210500 Icon Type: Full Octagon</p>		<p>N/A</p>
<p>SENSORS</p> <p>Type: Entity Symbol Set Code: 15 Code: 220000</p>	<p>N/A</p>	<p>No icon is associated with this entity. It is for hierarchal purposes only.</p>
<p>SENSOR</p> <p>Type: Entity Type Symbol Set Code: 15 Code: 220100 Icon Type: Main</p>		<p>N/A</p>
<p>SENSOR EMPLACED</p> <p>Type: Entity Type Entity: SENSOR Symbol Set Code: 15 Code: 220200 Icon Type: Full Octagon</p>		<p>N/A</p>
<p>RADAR</p> <p>Type: Entity Type Entity: SENSOR Symbol Set Code: 15 Code: 220300 Icon Type: Full Octagon</p>		<p>N/A</p>

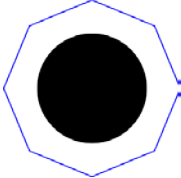
TABLE D-XI. Land equipment icons - Continued.

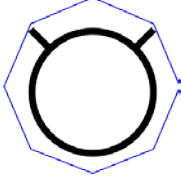
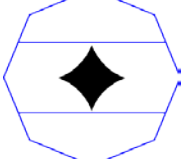
DESCRIPTION	ICON	REMARKS
EMERGENCY OPERATION Type: Entity Symbol Set Code: 15 Code: 230000 Icon Type: Full Octagon		
AMBULANCE Type: Entity Type Entity/Entity Type: EMERGENCY OPERATION Symbol Set Code: 15 Code: 230100 Icon Type: Full Octagon		N/A
FIRE FIGHTING/FIRE PROTECTION Type: Entity Type Entity/Entity Type: EMERGENCY OPERATION Symbol Set Code: 15 Code: 230200 Icon Type: Main		N/A
MANUAL TRACK Type: Entity (Local) Symbol Set Code: 15 Code: 230000 Icon Type: Full Octagon		N/A

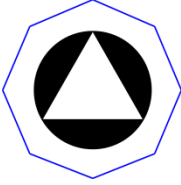
D.8.3 Land equipment sector 1 modifiers. Land equipment sector 1 modifiers denote sensor type category. [Table D-XII](#) lists land equipment sector 1 modifiers and illustrates their placement within the bounding octagon.

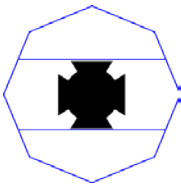
TABLE D-XII. Land equipment sector 1 modifiers.

DESCRIPTION	CATEGORY	MODIFIER	REMARKS
BIOLOGICAL Symbol Set Code: 15 Code: 01	SENSOR TYPE		N/A

TABLE D-XII. Land equipment sector 1 modifiers - Continued.

DESCRIPTION	CATEGORY	MODIFIER	REMARKS
CHEMICAL Symbol Set Code: 15 Code: 02	SENSOR TYPE		N/A
EARLY WARNING RADAR Symbol Set Code: 15 Code: 03	SENSOR TYPE		N/A
INTRUSION Symbol Set Code: 15 Code: 04	SENSOR TYPE		N/A
NUCLEAR Symbol Set Code: 15 Code: 05	SENSOR TYPE		N/A
RADIOLOGICAL Symbol Set Code: 15 Code: 06	SENSOR TYPE		N/A
UPGRADED EARLY WARNING RADAR Symbol Set Code: 15 Code: 07	SENSOR TYPE		N/A
HIJACKING Symbol Set Code: 15 Code: 08	CRIME		N/A
CIVILIAN Symbol Set Code: 15 Code: 09	ORGANIZATION		N/A

D.9 LAND INSTALLATION SYMBOLS

D.9.1 Land installation symbols. This section includes the lists of icons and modifiers for building land installation symbols.

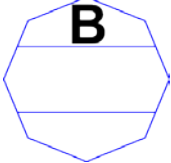
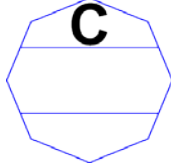
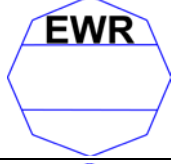
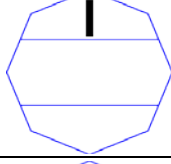
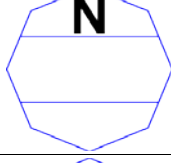
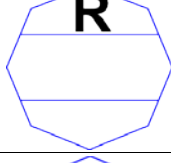
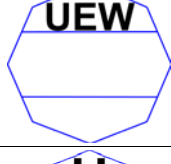
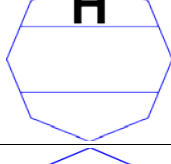
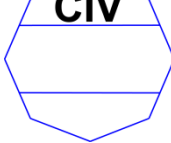
D.9.2 Land installation icons. [Table D-XIII](#) depicts land installation icons.

TABLE D-XIII. Land installation icons.



DESCRIPTION	ICON	REMARKS
<p>INSTALLATION</p> <p>Type: Entity Symbol Set Code: 20 Code: 110000</p>		<p>This symbol shall not be displayed on a C2 system but may be displayed for training or hierarchal explanation purposes.</p>
<p>AIRCRAFT PRODUCTION/ASSEMBLY</p> <p>Type: Entity Type Entity: INSTALLATION Symbol Set Code: 20 Code: 110100 Icon Type: Main</p>		<p>N/A</p>
<p>AMMUNITION AND EXPLOSIVE/PRODUCTION</p> <p>Type: Entity Type Entity: INSTALLATION Symbol Set Code: 20 Code: 110200 Icon Type: Full Octagon</p>		<p>N/A</p>
<p>AMMUNITION CACHE</p> <p>Type: Entity Type Entity: INSTALLATION Symbol Set Code: 20 Code: 110300 Icon Type: Full Frame</p>		<p>The grey box is not to be drawn. It is shown here only as a reference to position and proportion of the icon within the frame.</p>
<p>ARMAMENT PRODUCTION</p> <p>Type: Entity Type Entity: INSTALLATION Symbol Set Code: 20 Code: 110400 Icon Type: Full Octagon</p>		<p>N/A</p>
<p>BLACK LIST LOCATION</p> <p>Type: Entity Type Entity: INSTALLATION Symbol Set Code: 20 Code: 110500 Icon Type: Main</p>		<p>N/A</p>

TABLE D-XIII. Land installation icons - Continued.

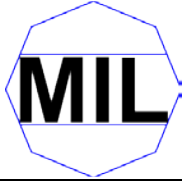
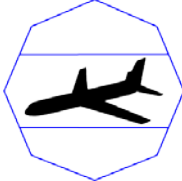
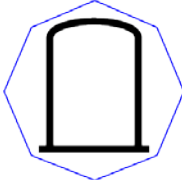
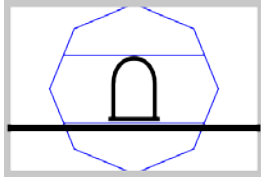
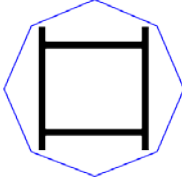

DESCRIPTION	ICON	REMARKS
CHEMICAL, BIOLOGICAL, RADIOLOGICAL AND NUCLEAR (CBRN) Type: Entity Type Entity: INSTALLATION Symbol Set Code: 20 Code: 110600 Icon Type: Main		N/A
ENGINEER EQUIPMENT PRODUCTION Type: Entity Type Entity: INSTALLATION Symbol Set Code: 20 Code: 110700 Icon Type: Full Octagon		N/A
BRIDGE Type: Entity Type Entity: INSTALLATION/ENGINEER EQUIPMENT PRODUCTION Symbol Set Code: 20 Code: 110701 Icon Type: Main		N/A
EQUIPMENT MANUFACTURE Type: Entity Type Entity: INSTALLATION Symbol Set Code: 20 Code: 110800 Icon Type: Full Octagon		N/A
GOVERNMENT LEADERSHIP Type: Entity Type Entity: INSTALLATION Symbol Set Code: 20 Code: 110900 Icon Type: Main		N/A
GRAY LIST LOCATION Type: Entity Type Entity: INSTALLATION Symbol Set Code: 20 Code: 111000 Icon Type: Main		N/A

TABLE D-XIII. Land installation icons - Continued.

DESCRIPTION	ICON	REMARKS
<p>MASS GRAVE SITE</p> <p>Type: Entity Type Entity: INSTALLATION Symbol Set Code: 20 Code: 111100 Icon Type: Main</p>		<p>N/A</p>
<p>MATERIEL</p> <p>Type: Entity Type Entity: INSTALLATION Symbol Set Code: 20 Code: 111200 Icon Type: Full Frame</p>		<p>The grey box is not to be drawn. It is shown here only as a reference to position and proportion of the icon within the frame.</p>
<p>MINE</p> <p>Type: Entity Type Entity: INSTALLATION Symbol Set Code: 20 Code: 111300 Icon Type: Main</p>		<p>N/A</p>
<p>MISSILE AND SPACE SYSTEM PRODUCTION</p> <p>Type: Entity Type Entity: INSTALLATION Symbol Set Code: 20 Code: 111400 Icon Type: Full Octagon</p>		<p>N/A</p>
<p>NUCLEAR (NON CBRN DEFENSE)</p> <p>Type: Entity Type Entity: INSTALLATION Symbol Set Code: 20 Code: 111500 Icon Type: Main</p>		<p>N/A</p>
<p>PRINTED MEDIA</p> <p>Type: Entity Type Entity: INSTALLATION Symbol Set Code: 20 Code: 111600 Icon Type: Main</p>		<p>N/A</p>

TABLE D-XIII. Land installation icons - Continued.

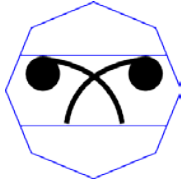
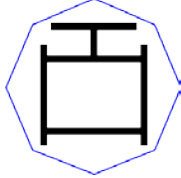
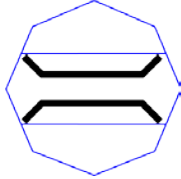
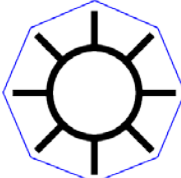
DESCRIPTION	ICON	REMARKS
SAFE HOUSE Type: Entity Type Entity: INSTALLATION Symbol Set Code: 20 Code: 111700 Icon Type: Main		N/A
WHITE LIST LOCATION Type: Entity Type Entity: INSTALLATION Symbol Set Code: 20 Code: 111800 Icon Type: Main		N/A
TENTED CAMP Type: Entity Type Entity: INSTALLATION Symbol Set Code: 20 Code: 111900 Icon Type: Full Octagon		N/A
DISPLACED PERSONS/ REFUGEE/EVACUEES CAMP Type: Entity Subtype Entity/Entity Type: INSTALLATION/TENTED CAMP Symbol Set Code: 20 Code: 111901 Icon Type: Full Octagon		N/A
TRAINING CAMP Type: Entity Subtype Entity/Entity Type: INSTALLATION/TENTED CAMP Symbol Set Code: 20 Code: 111902 Icon Type: Full Octagon		N/A
WAREHOUSE/STORAGE FACILITY Type: Entity Type Entity: INSTALLATION Symbol Set Code: 20 Code: 112000 Icon Type: Full Octagon		N/A

TABLE D-XIII. Land installation icons - Continued.



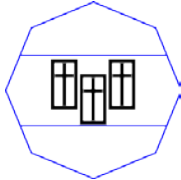
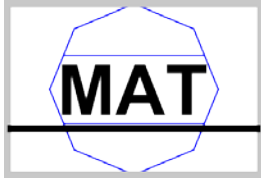
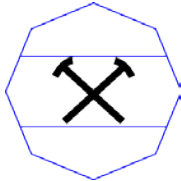
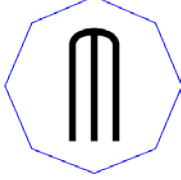
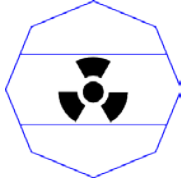
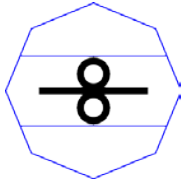

DESCRIPTION	ICON	REMARKS
<p>LAW ENFORCEMENT</p> <p>Type: Entity Type Entity: INSTALLATION Symbol Set Code: 20 Code: 112100</p>		N/A
<p>BUREAU OF ALCOHOL, TOBACCO, FIREARMS AND EXPLOSIVES (ATF) (DEPARTMENT OF JUSTICE)</p> <p>Type: Entity Subtype Entity/Entity Type: INSTALLATION/ LAW ENFORCEMENT Symbol Set Code: 20 Code: 112101 Icon Type: Main</p>		N/A
<p>BORDER PATROL</p> <p>Type: Entity Subtype Entity/Entity Type: INSTALLATION/ LAW ENFORCEMENT Symbol Set Code: 20 Code: 112102 Icon Type: Full Octagon</p>		N/A
<p>CUSTOMS SERVICE</p> <p>Type: Entity Subtype Entity/Entity Type: INSTALLATION/ LAW ENFORCEMENT Symbol Set Code: 20 Code: 112103 Icon Type: Full Octagon</p>		N/A
<p>DRUG ENFORCEMENT AGENCY (DEA)</p> <p>Type: Entity Subtype Entity/Entity Type: INSTALLATION/ LAW ENFORCEMENT Symbol Set Code: 20 Code: 112104 Icon Type: Main</p>		N/A

TABLE D-XIII. Land installation icons - Continued.



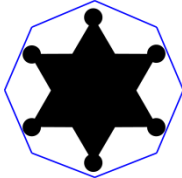

DESCRIPTION	ICON	REMARKS
DEPARTMENT OF JUSTICE (DOJ) Type: Entity Subtype Entity/Entity Type: INSTALLATION/ LAW ENFORCEMENT Symbol Set Code: 20 Code: 112105 Icon Type: Full Octagon		N/A
FEDERAL BUREAU OF INVESTIGATION (FBI) Type: Entity Subtype Entity/Entity Type: INSTALLATION/ LAW ENFORCEMENT Symbol Set Code: 20 Code: 112106 Icon Type: Main		N/A
POLICE Type: Entity Subtype Entity/Entity Type: INSTALLATION/ LAW ENFORCEMENT Symbol Set Code: 20 Code: 112107 Icon Type: Main		N/A
PRISON Type: Entity Subtype Entity/Entity Type: INSTALLATION/ LAW ENFORCEMENT Symbol Set Code: 20 Code: 112108 Icon Type: Full Octagon		N/A
UNITED STATES SECRET SERVICE (TREAS) (USSS) Type: Entity Subtype Entity/Entity Type: INSTALLATION/ LAW ENFORCEMENT Symbol Set Code: 20 Code: 112109 Icon Type: Main		N/A

TABLE D-XIII. Land installation icons - Continued.



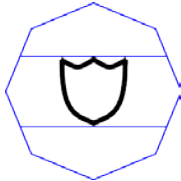

DESCRIPTION	ICON	REMARKS
TRANSPORTATION SECURITY ADMINISTRATION (TSA) Type: Entity Subtype Entity/Entity Type: INSTALLATION/ LAW ENFORCEMENT Symbol Set Code: 20 Code: 112110 Icon Type: Main		N/A
COAST GUARD Type: Entity Subtype Entity/Entity Type: INSTALLATION/ LAW ENFORCEMENT Symbol Set Code: 20 Code: 112111 Icon Type: Full Octagon		N/A
US MARSHALS SERVICE Type: Entity Subtype Entity/Entity Type: INSTALLATION/ LAW ENFORCEMENT Symbol Set Code: 20 Code: 112112 Icon Type: Full Octagon		N/A
EMERGENCY OPERATION Type: Entity Type Entity: INSTALLATION Symbol Set Code: 20 Code: 112200		N/A
FIRE STATION Type: Entity Subtype Entity/Entity Type: INSTALLATION/ EMERGENCY OPERATION Symbol Set Code: 20 Code: 112201 Icon Type: Full Octagon		N/A
EMERGENCY MEDICAL OPERATION Type: Entity Type Entity: INSTALLATION/ EMERGENCY OPERATION Symbol Set Code: 20 Code: 112202 Icon Type: Full Octagon		N/A

TABLE D-XIII. Land installation icons - Continued.



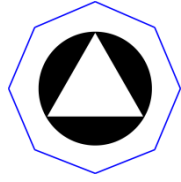
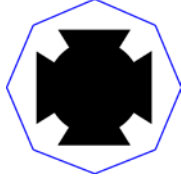

DESCRIPTION	ICON	REMARKS
<p>INFRASTRUCTURE</p> <p>Type: Entity Symbol Set Code: 20 Code: 120000</p>	<p>N/A</p>	<p>No icon is associated with this entity. It is for hierarchal purposes only.</p>
<p>AGRICULTURE AND FOOD INFRASTRUCTURE</p> <p>Type: Entity Type Entity: INFRASTRUCTURE Symbol Set Code: 20 Code: 120100 Icon Type: Full Octagon</p>		<p>N/A</p>
<p>AGRICULTURAL LABORATORY</p> <p>Type: Entity Subtype Entity/Entity Type: INFRASTRUCTURE/ AGRICULTURAL LABORATORY Symbol Set Code: 20 Code: 120101 Icon Type: Full Octagon</p>		<p>N/A</p>
<p>ANIMAL FEEDLOT</p> <p>Type: Entity Subtype Entity/Entity Type: INFRASTRUCTURE/ AGRICULTURAL LABORATORY Symbol Set Code: 20 Code: 120102 Icon Type: Full Octagon</p>		<p>N/A</p>
<p>COMMERCIAL FOOD DISTRIBUTION CENTER</p> <p>Type: Entity Subtype Entity/Entity Type: INFRASTRUCTURE/ AGRICULTURAL LABORATORY Symbol Set Code: 20 Code: 120103 Icon Type: Full Octagon</p>		<p>The grey box is not to be drawn. It is shown here only as a reference to position and proportion of the icon within the frame.</p>
<p>FARM/RANCH</p> <p>Type: Entity Subtype Entity/Entity Type: INFRASTRUCTURE/ AGRICULTURAL LABORATORY Symbol Set Code: 20 Code: 120104 Icon Type: Full Octagon</p>		<p>N/A</p>

TABLE D-XIII. Land installation icons - Continued.

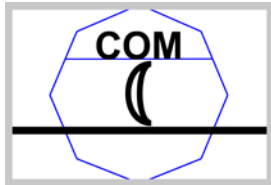

DESCRIPTION	ICON	REMARKS
<p>FOOD DISTRIBUTION</p> <p>Type: Entity Subtype Entity/Entity Type: INFRASTRUCTURE/ AGRICULTURAL LABORATORY Symbol Set Code: 20 Code: 120105 Icon Type: Full Frame</p>		<p>The grey box is not to be drawn. It is shown here only as a reference to position and proportion of the icon within the frame.</p>
<p>FOOD PRODUCTION CENTER</p> <p>Type: Entity Subtype Entity/Entity Type: INFRASTRUCTURE/ AGRICULTURAL LABORATORY Symbol Set Code: 20 Code: 120106 Icon Type: Full Octagon</p>		<p>The grey box is not to be drawn. It is shown here only as a reference to position and proportion of the icon within the frame.</p>
<p>FOOD RETAIL</p> <p>Type: Entity Subtype Entity/Entity Type: INFRASTRUCTURE/ AGRICULTURAL LABORATORY Symbol Set Code: 20 Code: 120107 Icon Type: Full Octagon</p>		<p>The grey box is not to be drawn. It is shown here only as a reference to position and proportion of the icon within the frame.</p>
<p>GRAIN STORAGE</p> <p>Type: Entity Subtype Entity/Entity Type: INFRASTRUCTURE/ AGRICULTURAL LABORATORY Symbol Set Code: 20 Code: 120108 Icon Type: Full Octagon</p>		<p>N/A</p>
<p>BANKING FINANCE AND INSURANCE INFRASTRUCTURE</p> <p>Type: Entity Type Entity: INFRASTRUCTURE Symbol Set Code: 20 Code: 120200 Icon Type: Full Octagon</p>		<p>N/A</p>

TABLE D-XIII. Land installation icons - Continued.



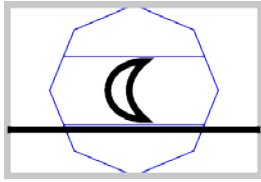
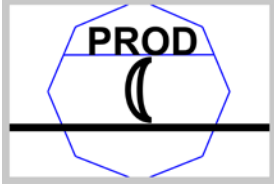
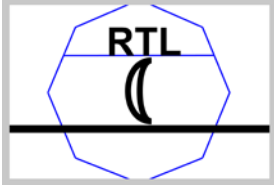

DESCRIPTION	ICON	REMARKS
<p>ATM</p> <p>Type: Entity Subtype Entity/Entity Type: INFRASTRUCTURE/ BANKING FINANCE AND INSURANCE INFRASTRUCTURE Symbol Set Code: 20 Code: 120201 Icon Type: Full Octagon</p>		<p>N/A</p>
<p>BANK</p> <p>Type: Entity Subtype Entity/Entity Type: INFRASTRUCTURE/ BANKING FINANCE AND INSURANCE INFRASTRUCTURE Symbol Set Code: 20 Code: 120202 Icon Type: Full Octagon</p>		<p>N/A</p>
<p>BULLION STORAGE</p> <p>Type: Entity Subtype Entity/Entity Type: INFRASTRUCTURE/ BANKING FINANCE AND INSURANCE INFRASTRUCTURE Symbol Set Code: 20 Code: 120203 Icon Type: Full Octagon</p>		<p>N/A</p>
<p>ECONOMIC INFRASTRUCTURE ASSET</p> <p>Type: Entity Subtype Entity/Entity Type: INFRASTRUCTURE/ BANKING FINANCE AND INSURANCE INFRASTRUCTURE Symbol Set Code: 20 Code: 120204 Icon Type: Full Frame</p>		<p>N/A</p>
<p>FEDERAL RESERVE BANK</p> <p>Type: Entity Subtype Entity/Entity Type: INFRASTRUCTURE/ BANKING FINANCE AND INSURANCE INFRASTRUCTURE Symbol Set Code: 20 Code: 120205 Icon Type: Full Octagon</p>		<p>N/A</p>

TABLE D-XIII. Land installation icons - Continued.





DESCRIPTION	ICON	REMARKS
FINANCIAL EXCHANGE Type: Entity Subtype Entity/Entity Type: INFRASTRUCTURE/ BANKING FINANCE AND INSURANCE INFRASTRUCTURE Symbol Set Code: 20 Code: 120206 Icon Type: Full Octagon		N/A
FINANCIAL SERVICES, OTHER Type: Entity Subtype Entity/Entity Type: INFRASTRUCTURE/ BANKING FINANCE AND INSURANCE INFRASTRUCTURE Symbol Set Code: 20 Code: 120207 Icon Type: Full Octagon		N/A
COMMERCIAL INFRASTRUCTURE Type: Entity Type Entity: INFRASTRUCTURE Symbol Set Code: 20 Code: 120300 Icon Type: Full Octagon		N/A
CHEMICAL PLANT Type: Entity Subtype Entity/Entity Type: INFRASTRUCTURE/ COMMERCIAL INFRASTRUCTURE Symbol Set Code: 20 Code: 120301 Icon Type: Full Octagon		N/A
FIREARMS MANUFACTURER Type: Entity Subtype Entity/Entity Type: INFRASTRUCTURE/ COMMERCIAL INFRASTRUCTURE Symbol Set Code: 20 Code: 120302 Icon Type: Full Octagon		N/A

TABLE D-XIII. Land installation icons - Continued.

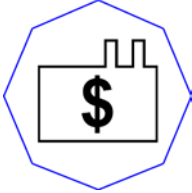

DESCRIPTION	ICON	REMARKS
<p>FIREARMS RETAILER</p> <p>Type: Entity Subtype Entity/Entity Type: INFRASTRUCTURE/ COMMERCIAL INFRASTRUCTURE Symbol Set Code: 20 Code: 120303 Icon Type: Full Octagon</p>		<p>N/A</p>
<p>HAZARDOUS MATERIAL PRODUCTION</p> <p>Type: Entity Subtype Entity/Entity Type: INFRASTRUCTURE/ COMMERCIAL INFRASTRUCTURE Symbol Set Code: 20 Code: 120304 Icon Type: Full Octagon</p>		<p>N/A</p>
<p>HAZARDOUS MATERIAL STORAGE</p> <p>Type: Entity Subtype Entity/Entity Type: INFRASTRUCTURE/ COMMERCIAL INFRASTRUCTURE Symbol Set Code: 20 Code: 120305 Icon Type: Full Octagon</p>		<p>N/A</p>
<p>INDUSTRIAL SITE</p> <p>Type: Entity Subtype Entity/Entity Type: INFRASTRUCTURE/ COMMERCIAL INFRASTRUCTURE Symbol Set Code: 20 Code: 120306 Icon Type: Full Octagon</p>		<p>N/A</p>

TABLE D-XIII. Land installation icons - Continued.



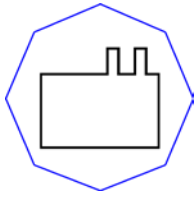

DESCRIPTION	ICON	REMARKS
<p>LANDFILL</p> <p>Type: Entity Subtype Entity/Entity Type: INFRASTRUCTURE/ COMMERCIAL INFRASTRUCTURE Symbol Set Code: 20 Code: 120307 Icon Type: Full Octagon</p>		<p>N/A</p>
<p>PHARMACEUTICAL MANUFACTURER</p> <p>Type: Entity Subtype Entity/Entity Type: INFRASTRUCTURE/ COMMERCIAL INFRASTRUCTURE Symbol Set Code: 20 Code: 120308 Icon Type: Full Octagon</p>		<p>N/A</p>
<p>CONTAMINATED HAZARDOUS WASTE SITE</p> <p>Type: Entity Subtype Entity/Entity Type: INFRASTRUCTURE/ COMMERCIAL INFRASTRUCTURE Symbol Set Code: 20 Code: 120309 Icon Type: Full Octagon</p>		<p>N/A</p>
<p>TOXIC RELEASE INVENTORY</p> <p>Type: Entity Subtype Entity/Entity Type: INFRASTRUCTURE/ COMMERCIAL INFRASTRUCTURE Symbol Set Code: 20 Code: 120310 Icon Type: Full Octagon</p>		<p>N/A</p>
<p>EDUCATIONAL FACILITIES INFRASTRUCTURE</p> <p>Type: Entity Type Entity: INFRASTRUCTURE Symbol Set Code: 20 Code: 120400 Icon Type: Full Octagon</p>		<p>N/A</p>

TABLE D-XIII. Land installation icons - Continued.



DESCRIPTION	ICON	REMARKS
<p>COLLEGE/UNIVERSITY</p> <p>Type: Entity Subtype Entity/Entity Type: INFRASTRUCTURE/EDUCATIONAL FACILITIES INFRASTRUCTURE Symbol Set Code: 20 Code: 120401 Icon Type: Full Octagon</p>		<p>N/A</p>
<p>SCHOOL</p> <p>Type: Entity Subtype Entity/Entity Type: INFRASTRUCTURE/EDUCATIONAL FACILITIES INFRASTRUCTURE Symbol Set Code: 20 Code: 120402 Icon Type: Full Octagon</p>		<p>N/A</p>
<p>ENERGY FACILITIES INFRASTRUCTURE</p> <p>Type: Entity Type Entity: INFRASTRUCTURE Symbol Set Code: 20 Code: 120500 Icon Type: Full Octagon</p>		<p>N/A</p>
<p>ELECTRIC POWER</p> <p>Type: Entity Subtype Entity/Entity Type: INFRASTRUCTURE/ENERGY FACILITIES INFRASTRUCTURE Symbol Set Code: 20 Code: 120501 Icon Type: Main</p>		<p>N/A</p>
<p>GENERATION STATION</p> <p>Type: Entity Subtype Entity/Entity Type: INFRASTRUCTURE/ENERGY FACILITIES INFRASTRUCTURE Symbol Set Code: 20 Code: 120502 Icon Type: Full Octagon</p>		<p>N/A</p>

TABLE D-XIII. Land installation icons - Continued.

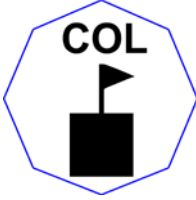
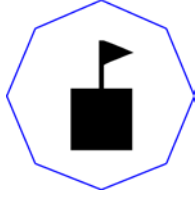
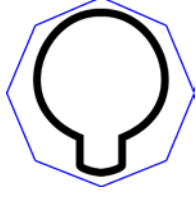
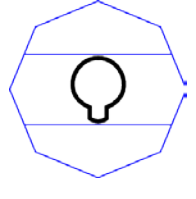

DESCRIPTION	ICON	REMARKS
<p>NATURAL GAS FACILITY</p> <p>Type: Entity Subtype Entity/Entity Type: INFRASTRUCTURE/ENERGY FACILITIES INFRASTRUCTURE Symbol Set Code: 20 Code: 120503 Icon Type: Full Octagon</p>		N/A
<p>PETROLEUM FACILITY</p> <p>Type: Entity Subtype Entity/Entity Type: INFRASTRUCTURE/ENERGY FACILITIES INFRASTRUCTURE Symbol Set Code: 20 Code: 120504 Icon Type: Full Octagon</p>		
<p>PETROLEUM/GAS/OIL</p> <p>Type: Entity Subtype Entity/Entity Type: INFRASTRUCTURE/ENERGY FACILITIES INFRASTRUCTURE Symbol Set Code: 20 Code: 120505 Icon Type: Main</p>		N/A
<p>PROPANE FACILITY</p> <p>Type: Entity Subtype Entity/Entity Type: INFRASTRUCTURE/ENERGY FACILITIES INFRASTRUCTURE Symbol Set Code: 20 Code: 120506 Icon Type: Full Octagon</p>		N/A
<p>GOVERNMENT SITE INFRASTRUCTURE</p> <p>Type: Entity Type Entity: INFRASTRUCTURE Symbol Set Code: 20 Code: 120600 Icon Type: Full Octagon</p>		N/A
<p>MEDICAL INFRASTRUCTURE</p> <p>Type: Entity Type Entity: INFRASTRUCTURE Symbol Set Code: 20 Code: 120700</p>	N/A	No icon is associated with this entity. It is for hierarchal purposes only.

TABLE D-XIII. Land installation icons - Continued.

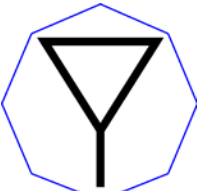
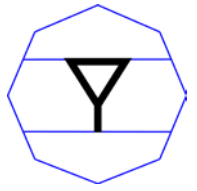

DESCRIPTION	ICON	REMARKS
<p>MEDICAL</p> <p>Type: Entity Type Entity: INSTALLATION Symbol Set Code: 20 Code: 120701 Icon Type: Full Frame</p>		<p>The grey box is not to be drawn. It is shown here only as a reference to position and proportion of the icon within the frame.</p>
<p>MEDICAL TREATMENT FACILITY (HOSPITAL)</p> <p>Type: Entity Type Entity: INSTALLATION Symbol Set Code: 20 Code: 120702 Icon Type: Full Frame</p>		<p>The grey box is not to be drawn. It is shown here only as a reference to position and proportion of the icon within the frame.</p>
<p>MILITARY INFRASTRUCTURE</p> <p>Type: Entity Type Entity: INFRASTRUCTURE Symbol Set Code: 20 Code: 120800 Icon Type: Full Octagon</p>		<p>N/A</p>
<p>MILITARY ARMORY</p> <p>Type: Entity Subtype Entity/Entity Type: INFRASTRUCTURE/MILITARY INFRASTRUCTURE Symbol Set Code: 20 Code: 120801 Icon Type: Full Octagon</p>		<p>N/A</p>
<p>MILITARY BASE</p> <p>Type: Entity Subtype Entity/Entity Type: INFRASTRUCTURE/MILITARY INFRASTRUCTURE Symbol Set Code: 20 Code: 120802 Icon Type: Full Octagon</p>		<p>N/A</p>
<p>POSTAL SERVICE INFRASTRUCTURE</p> <p>Type: Entity Type Entity: INFRASTRUCTURE Symbol Set Code: 20 Code: 120900 Icon Type: Full Octagon</p>		<p>N/A</p>

TABLE D-XIII. Land installation icons - Continued.



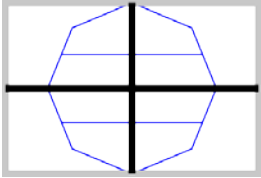
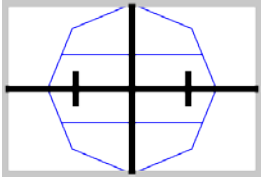

DESCRIPTION	ICON	REMARKS
<p>POSTAL DISTRIBUTION CENTER</p> <p>Type: Entity Subtype Entity/Entity Type: INFRASTRUCTURE/POSTAL SERVICE INFRASTRUCTURE Symbol Set Code: 20 Code: 120901 Icon Type: Full Octagon</p>		<p>N/A</p>
<p>POST OFFICE</p> <p>Type: Entity Subtype Entity/Entity Type: INFRASTRUCTURE/POSTAL SERVICE INFRASTRUCTURE Symbol Set Code: 20 Code: 120902 Icon Type: Full Octagon</p>		<p>N/A</p>
<p>PUBLIC VENUES INFRASTRUCTURE</p> <p>Type: Entity Type Entity: INFRASTRUCTURE Symbol Set Code: 20 Code: 121000 Icon Type: Full Octagon</p>		<p>N/A</p>
<p>ENCLOSED FACILITY (PUBLIC VENUE)</p> <p>Type: Entity Subtype Entity/Entity Type: INFRASTRUCTURE/PUBLIC VENUES INFRASTRUCTURE Symbol Set Code: 20 Code: 121001 Icon Type: Full Octagon</p>		<p>N/A</p>
<p>OPEN FACILITY (OPEN VENUE)</p> <p>Type: Entity Subtype Entity/Entity Type: INFRASTRUCTURE/PUBLIC VENUES INFRASTRUCTURE Symbol Set Code: 20 Code: 121002 Icon Type: Full Octagon</p>		<p>N/A</p>

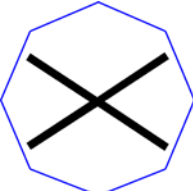
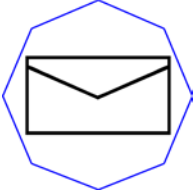
TABLE D-XIII. Land installation icons - Continued.





DESCRIPTION	ICON	REMARKS
<p>RECREATIONAL AREA</p> <p>Type: Entity Subtype Entity/Entity Type: INFRASTRUCTURE/PUBLIC VENUES INFRASTRUCTURE Symbol Set Code: 20 Code: 121003 Icon Type: Full Octagon</p>		<p>N/A</p>
<p>RELIGIOUS INSTITUTION</p> <p>Type: Entity Subtype Entity/Entity Type: INFRASTRUCTURE/PUBLIC VENUES INFRASTRUCTURE Symbol Set Code: 20 Code: 121004 Icon Type: Full Octagon</p>		<p>N/A</p>
<p>SPECIAL NEEDS INFRASTRUCTURE</p> <p>Type: Entity Type Entity: INFRASTRUCTURE Symbol Set Code: 20 Code: 121100 Icon Type: Full Octagon</p>		<p>N/A</p>
<p>ADULT DAY CARE</p> <p>Type: Entity Subtype Entity/Entity Type: INFRASTRUCTURE/SPECIAL NEEDS INFRASTRUCTURE Symbol Set Code: 20 Code: 121101 Icon Type: Full Octagon</p>		<p>N/A</p>
<p>CHILD DAY CARE</p> <p>Type: Entity Subtype Entity/Entity Type: INFRASTRUCTURE/SPECIAL NEEDS INFRASTRUCTURE Symbol Set Code: 20 Code: 121102 Icon Type: Full Octagon</p>		<p>N/A</p>

TABLE D-XIII. Land installation icons - Continued.



DESCRIPTION	ICON	REMARKS
<p>ELDER CARE</p> <p>Type: Entity Subtype Entity/Entity Type: INFRASTRUCTURE/SPECIAL NEEDS INFRASTRUCTURE Symbol Set Code: 20 Code: 121103 Icon Type: Full Octagon</p>		<p>N/A</p>
<p>TELECOMMUNICATIONS INFRASTRUCTURE</p> <p>Type: Entity Type Entity: INFRASTRUCTURE Symbol Set Code: 20 Code: 121200 Icon Type: Full Octagon</p>		<p>N/A</p>
<p>BROADCAST TRANSMITTER ANTENNAE</p> <p>Type: Entity Subtype Entity/Entity Type: INFRASTRUCTURE/ TELECOMMUNICATIONS INFRASTRUCTURE Symbol Set Code: 20 Code: 121201 Icon Type: Full Octagon</p>		<p>N/A</p>
<p>TELECOMMUNICATIONS (CIVILIAN)</p> <p>Type: Entity Subtype Entity/Entity Type: INFRASTRUCTURE/ TELECOMMUNICATIONS INFRASTRUCTURE Symbol Set Code: 20 Code: 121202 Icon Type: Main</p>		<p>N/A</p>
<p>TELECOMMUNICATIONS TOWER</p> <p>Type: Entity Subtype Entity/Entity Type: INFRASTRUCTURE/ TELECOMMUNICATIONS INFRASTRUCTURE Symbol Set Code: 20 Code: 121203 Icon Type: Full Octagon</p>		<p>N/A</p>

TABLE D-XIII. Land installation icons - Continued.



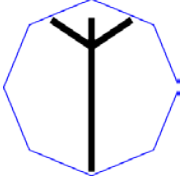
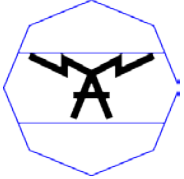
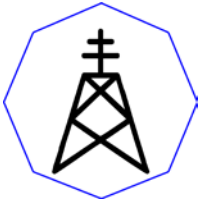

DESCRIPTION	ICON	REMARKS
<p>TRANSPORTATION INFRASTRUCTURE</p> <p>Type: Entity Type Entity: INFRASTRUCTURE Symbol Set Code: 20 Code: 121300 Icon Type: Full Octagon</p>		<p>N/A</p>
<p>AIRPORT/AIR BASE</p> <p>Type: Entity Subtype Entity/Entity Type: INFRASTRUCTURE/TRANSPORTATION INFRASTRUCTURE Symbol Set Code: 20 Code: 121301 Icon Type: Main+1</p>		<p>N/A</p>
<p>AIR TRAFFIC CONTROL FACILITY</p> <p>Type: Entity Subtype Entity/Entity Type: INFRASTRUCTURE/TRANSPORTATION INFRASTRUCTURE Symbol Set Code: 20 Code: 121302 Icon Type: Full Octagon</p>		<p>N/A</p>
<p>BUS STATION</p> <p>Type: Entity Subtype Entity/Entity Type: INFRASTRUCTURE/TRANSPORTATION INFRASTRUCTURE Symbol Set Code: 20 Code: 121303 Icon Type: Full Octagon</p>		<p>N/A</p>
<p>FERRY TERMINAL</p> <p>Type: Entity Subtype Entity/Entity Type: INFRASTRUCTURE/TRANSPORTATION INFRASTRUCTURE Symbol Set Code: 20 Code: 121304 Icon Type: Full Octagon</p>		<p>N/A</p>

TABLE D-XIII. Land installation icons - Continued.

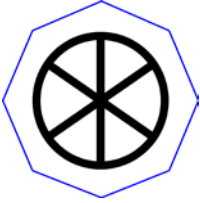
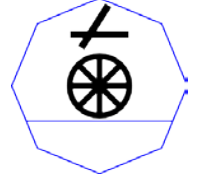

DESCRIPTION	ICON	REMARKS
<p>HELICOPTER LANDING SITE</p> <p>Type: Entity Subtype Entity/Entity Type: INFRASTRUCTURE/ TRANSPORTATION INFRASTRUCTURE Symbol Set Code: 20 Code: 121305 Icon Type: Full Octagon</p>		<p>N/A</p>
<p>MAINTENANCE FACILITY</p> <p>Type: Entity Subtype Entity/Entity Type: INFRASTRUCTURE/ TRANSPORTATION INFRASTRUCTURE Symbol Set Code: 20 Code: 121306 Icon Type: Full Octagon</p>		<p>N/A</p>
<p>RAILHEAD/RAILROAD STATION</p> <p>Type: Entity Subtype Entity/Entity Type: INFRASTRUCTURE/ TRANSPORTATION INFRASTRUCTURE Symbol Set Code: 20 Code: 121307 Icon Type: Main+1</p>		<p>N/A</p>
<p>REST STOP</p> <p>Type: Entity Subtype Entity/Entity Type: INFRASTRUCTURE/ TRANSPORTATION INFRASTRUCTURE Symbol Set Code: 20 Code: 121308 Icon Type: Full Octagon</p>		<p>N/A</p>
<p>SEA PORT/NAVAL BASE</p> <p>Type: Entity Subtype Entity/Entity Type: INFRASTRUCTURE/ TRANSPORTATION INFRASTRUCTURE Symbol Set Code: 20 Code: 121309 Icon Type: Main+1</p>		<p>N/A</p>

TABLE D-XIII. Land installation icons - Continued.



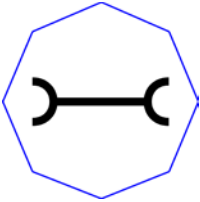
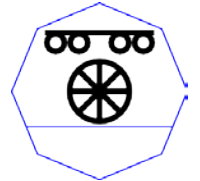

DESCRIPTION	ICON	REMARKS
<p>SHIP YARD</p> <p>Type: Entity Subtype Entity/Entity Type: INFRASTRUCTURE/ TRANSPORTATION INFRASTRUCTURE Symbol Set Code: 20 Code: 121310 Icon Type: Main+1</p>		<p>N/A</p>
<p>TOLL FACILITY</p> <p>Type: Entity Subtype Entity/Entity Type: INFRASTRUCTURE/ TRANSPORTATION INFRASTRUCTURE Symbol Set Code: 20 Code: 121311 Icon Type: Full Octagon</p>		<p>N/A</p>
<p>TRAFFIC INSPECTION FACILITY</p> <p>Type: Entity Subtype Entity/Entity Type: INFRASTRUCTURE/ TRANSPORTATION INFRASTRUCTURE Symbol Set Code: 20 Code: 121312 Icon Type: Full Octagon</p>		<p>N/A</p>
<p>TUNNEL</p> <p>Type: Entity Subtype Entity/Entity Type: INFRASTRUCTURE/ TRANSPORTATION INFRASTRUCTURE Symbol Set Code: 20 Code: 121313 Icon Type: Full Octagon</p>		<p>N/A</p>
<p>WATER SUPPLY INFRASTRUCTURE</p> <p>Type: Entity Type Entity: INFRASTRUCTURE Symbol Set Code: 20 Code: 121400 Icon Type: Full Octagon</p>		<p>N/A</p>

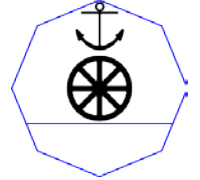
TABLE D-XIII. Land installation icons - Continued.

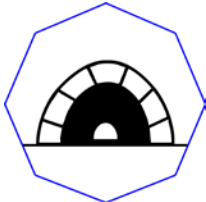

DESCRIPTION	ICON	REMARKS
<p>CONTROL VALVE</p> <p>Type: Entity Subtype Entity/Entity Type: INFRASTRUCTURE/ WATER SUPPLY INFRASTRUCTURE Symbol Set Code: 20 Code: 121401 Icon Type: Full Octagon</p>		N/A
<p>DAM</p> <p>Type: Entity Subtype Entity/Entity Type: INFRASTRUCTURE/ WATER SUPPLY INFRASTRUCTURE Symbol Set Code: 20 Code: 121402 Icon Type: Full Octagon</p>		N/A
<p>DISCHARGE OUTFALL</p> <p>Type: Entity Subtype Entity/Entity Type: INFRASTRUCTURE/ WATER SUPPLY INFRASTRUCTURE Symbol Set Code: 20 Code: 121403 Icon Type: Full Octagon</p>		N/A
<p>GROUND WATER WELL</p> <p>Type: Entity Subtype Entity/Entity Type: INFRASTRUCTURE/ WATER SUPPLY INFRASTRUCTURE Symbol Set Code: 20 Code: 121404 Icon Type: Full Octagon</p>		N/A
<p>PUMPING STATION</p> <p>Type: Entity Subtype Entity/Entity Type: INFRASTRUCTURE/ WATER SUPPLY INFRASTRUCTURE Symbol Set Code: 20 Code: 121405 Icon Type: Full Octagon</p>		N/A

TABLE D-XIII. Land installation icons - Continued.



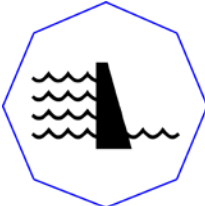

DESCRIPTION	ICON	REMARKS
<p>RESERVOIR</p> <p>Type: Entity Subtype Entity/Entity Type: INFRASTRUCTURE/ WATER SUPPLY INFRASTRUCTURE Symbol Set Code: 20 Code: 121406 Icon Type: Full Octagon</p>		<p>N/A</p>
<p>STORAGE TOWER</p> <p>Type: Entity Subtype Entity/Entity Type: INFRASTRUCTURE/ WATER SUPPLY INFRASTRUCTURE Symbol Set Code: 20 Code: 121407 Icon Type: Full Octagon</p>		<p>N/A</p>
<p>SURFACE WATER INTAKE</p> <p>Type: Entity Subtype Entity/Entity Type: INFRASTRUCTURE/ WATER SUPPLY INFRASTRUCTURE Symbol Set Code: 20 Code: 121408 Icon Type: Full Octagon</p>		<p>N/A</p>
<p>WASTEWATER TREATMENT FACILITY</p> <p>Type: Entity Subtype Entity/Entity Type: INFRASTRUCTURE/ WATER SUPPLY INFRASTRUCTURE Symbol Set Code: 20 Code: 121409 Icon Type: Full Octagon</p>		<p>N/A</p>
<p>WATER</p> <p>Type: Entity Subtype Entity/Entity Type: INFRASTRUCTURE/ WATER SUPPLY INFRASTRUCTURE Symbol Set Code: 20 Code: 121410 Icon Type: Main</p>		<p>N/A</p>

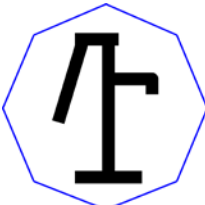
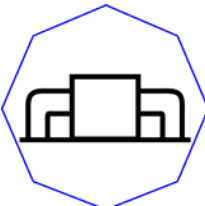
TABLE D-XIII. Land installation icons - Continued.

DESCRIPTION	ICON	REMARKS
WATER TREATMENT Type: Entity Subtype Entity/Entity Type: INFRASTRUCTURE/ WATER SUPPLY INFRASTRUCTURE Symbol Set Code: 20 Code: 121411 Icon Type: Main		N/A

D.9.3 Land installation sector 1 modifiers. Land installation sector 1 modifiers denote CBRN type, electric power type and civilian telecommunications type categories. [Table D-XIV](#) lists land installation sector 1 modifiers and illustrates their placement within the bounding octagon.

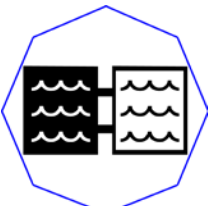
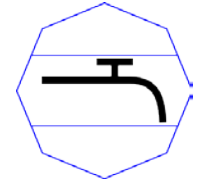
TABLE D-XIV. Land installation sector 1 modifiers.

DESCRIPTION	CATEGORY	MODIFIER	REMARKS
BIOLOGICAL Symbol Set Code: 20 Code: 01	CBRN TYPE		N/A
CHEMICAL Symbol Set Code: 20 Code: 02	CBRN TYPE		N/A
NUCLEAR Symbol Set Code: 20 Code: 03	CBRN TYPE		N/A
RADIOLOGICAL Symbol Set Code: 20 Code: 04	CBRN TYPE		N/A
DECONTAMINATION Symbol Set Code: 20 Code: 05	CBRN TYPE		N/A

TABLE D-XIV. Land installation sector 1 modifiers - Continued.

DESCRIPTION	CATEGORY	MODIFIER	REMARKS
COAL Symbol Set Code: 20 Code: 06	ELECTRIC POWER TYPE		N/A
GEOHERMAL Symbol Set Code: 20 Code: 07	ELECTRIC POWER TYPE		N/A
HYDROELECTRIC Symbol Set Code: 20 Code: 08	ELECTRIC POWER TYPE		N/A
NATURAL GAS Symbol Set Code: 20 Code: 00	ELECTRIC POWER TYPE		N/A
PETROLEUM Symbol Set Code: 20 Code: 10	ELECTRIC POWER TYPE		N/A
CIVILIAN Symbol Set Code: 20 Code: 11	OPERATION		N/A
CIVILIAN TELEPHONE Symbol Set Code: 20 Code: 12	CIVILIAN TELECOMMUNICATIONS TYPE		N/A
CIVILIAN TELEVISION Symbol Set Code: 20 Code: 13	CIVILIAN TELECOMMUNICATIONS TYPE		N/A

MIL-STD-2525D - APPENDIX D

D.9.4 Land installation sector 2 modifiers. Land installation_sector 2 modifiers denote warfare capability category. [Table D-XV](#) lists the land installation_sector 2 modifiers and illustrates their placement within the bounding octagon.

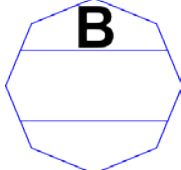
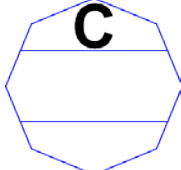
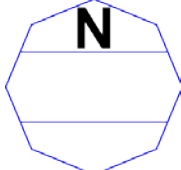
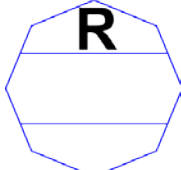
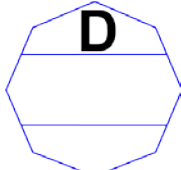
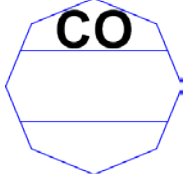
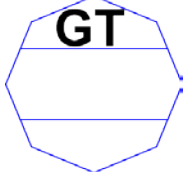
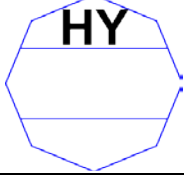
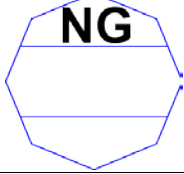
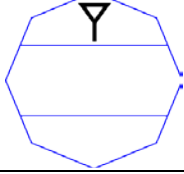
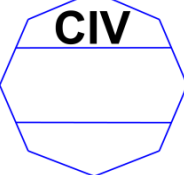
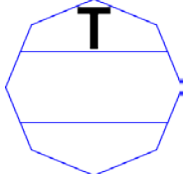
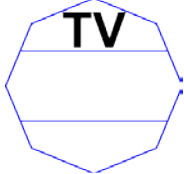
TABLE D-XV. Land installation sector 2 modifiers.

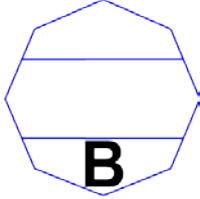
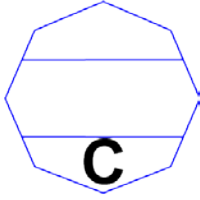
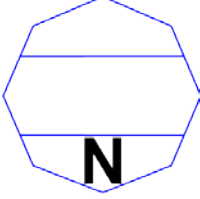
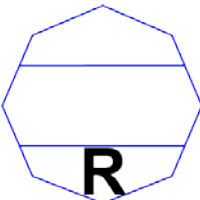
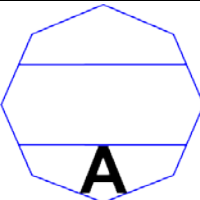
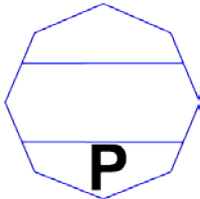
DESCRIPTION	CATEGORY	MODIFIER	REMARKS
BIOLOGICAL WARFARE PRODUCTION Symbol Set Code: 12 Code: 01			N/A
CHEMICAL WARFARE PRODUCTION Symbol Set Code: 12 Code: 02			N/A
NUCLEAR WARFARE PRODUCTION Nuclear Warfare Production Symbol Set Code: 12 Code: 03			N/A
RADIOLOGICAL WARFARE PRODUCTION Radiological Warfare Production Symbol Set Code: 12 Code: 04			N/A
ATOMIC ENERGY REACTOR Symbol Set Code: 12 Code: 05			N/A
NUCLEAR MATERIAL PRODUCTION Symbol Set Code: 12 Code: 06			N/A

MIL-STD-2525D - APPENDIX D

TABLE D-XV. Land installation sector 2 modifiers - Continued.

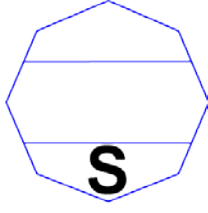
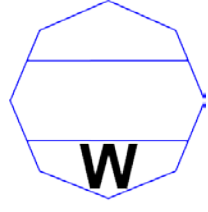
<p>NUCLEAR MATERIAL STORAGE</p> <p>Symbol Set Code: 12 Code: 07</p>			<p>N/A</p>
<p>WEAPONS GRADE PRODUCTION</p> <p>Symbol Set Code: 12 Code: 08</p>			<p>N/A</p>

PAGE INTENTIONALLY LEFT BLANK

APPENDIX E - SEA SURFACE SYMBOLS

E.1 SCOPE

E.1.1 Scope. This appendix addresses symbols that support sea surface units, equipment and installations (UEI) in the C2 domain. The tables in this appendix present the icons and modifiers for the sea surface domain. This appendix is a mandatory part of the standard. The information contained herein is intended for compliance.

E.2 APPLICABLE DOCUMENTS

Specific documents in [2.2](#) of this standard apply to this appendix.

E.3 DEFINITIONS

The definitions in [section 3](#) of this standard apply to this appendix.

E.4 GENERAL REQUIREMENTS

E.4.1 Organization. This appendix contains technical specifications, a symbol coding scheme, a symbology hierarchy and sea surface symbology.

E.5 DETAILED REQUIREMENTS

E.5.1 Technical specifications. Composition, construction and display of symbols are explained in the detailed requirements section of the standard.

E.5.2 Symbol identification coding scheme. A symbol identification code (SIDC) is a numeric string that may be used to provide the unique identifier necessary to display or exchange symbol information between MIL-STD-2525 compliant systems. Refer to [Appendix A](#) for SIDC positions and descriptions.

E.5.3 Composition of sea surface symbols. A standard method for constructing symbols is presented. Refer to [5.3.8](#) for an explanation of symbol composition. [Figure E-1](#) shows an example of a sea surface equipment symbol.

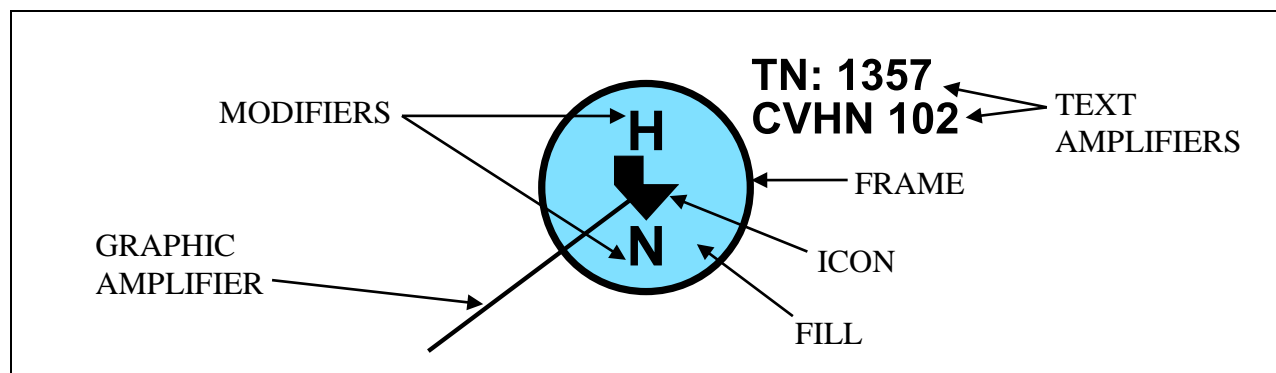
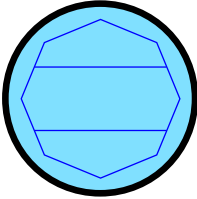
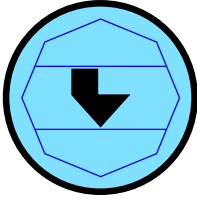
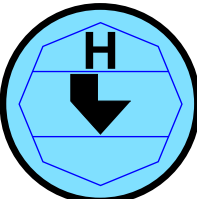
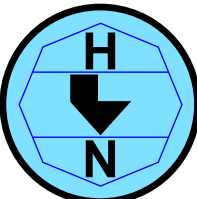



FIGURE E-1. Sea surface symbol components.

E.5.3.1 Symbol building process. [Table E-I](#) depicts the symbol building process for sea surface symbols. The process is identical for icons and modifiers requiring the vertical bounding octagon.

TABLE E-I. Sea surface symbol building process.

STEP	DESCRIPTION	EXAMPLE
1.	<p>Choose the frame that matches the standard identity of the object from the sea surface column in tables I, II, or III. In this example, the standard identity is friend.</p> <p>The example depicts a “friendly sea surface track.”</p>	
2.	<p>Choose an icon for the main sector of the bounding octagon. In this example, the icon is “carrier,” a sea surface entity type.</p> <p>The example depicts a “friendly military combatant carrier.”</p>	
3.	<p>If required, choose a modifier to depict an additional characteristic of the icon. In this example, the modifier is “helicopter equipped/VTOL,” a sector 1 modifier.</p> <p>The example depicts a “friendly military combatant carrier, helicopter equipped/VTOL.”</p>	
4.	<p>If required, choose a modifier to depict another characteristic of the icon. In this example, the modifier is “nuclear powered,” a sector 2 modifier.</p> <p>The example depicts a “friendly military combatant carrier, helicopter equipped/VTOL, nuclear powered.”</p>	
5.	<p>The finished symbol will appear as shown in the example.</p>	

E.5.3.2 Icons and modifiers. All icons shall be placed within the main sector of the bounding octagon ([see table D-I](#)). When depicted, modifiers shall be placed in sectors 1 or 2 as

appropriate (see table D-I). Only one modifier may be placed in each sector at a given time. Multiple modifiers in the same position are prohibited due to legibility concerns.

E.5.3.3 Amplifiers.

E.5.3.3.1 Text amplifiers. The purpose of the static text amplifiers described in this appendix is to standardize the display of additional alphanumeric information on identity, movement and location and capabilities. See 5.1.6 for more information on amplifiers.

Figure E-2 shows the placement of sea surface symbol amplifiers around the friend symbol frame. Table D-II provides descriptions and formats of each amplifier.

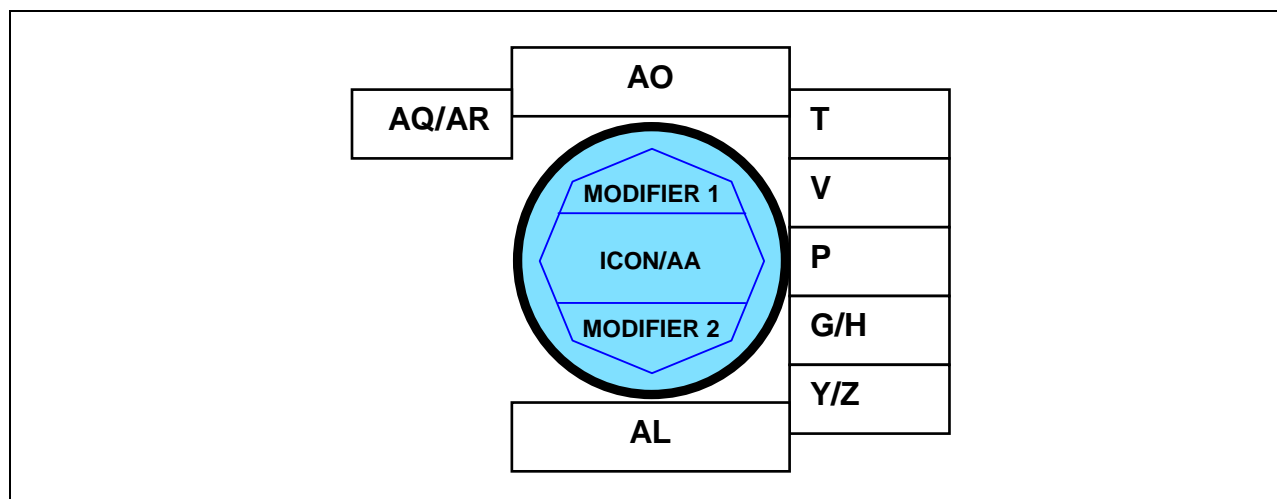

FIGURE E-2. Placement of sea surface symbol amplifiers.

TABLE E-II. Descriptions and formats of sea surface symbol amplifiers.

FIELD	FIELD TITLE	DESCRIPTION	FORMAT
A	Ship/Ship Type Icon	Uses icon and sector modifiers	
G	Staff Comments	A text amplifier for units, equipment and installations; content is implementation specific.	
H	Additional Information	A text amplifier for units, equipment and installations; content is implementation specific.	
P	Automatic Identification System (AIS)	A text amplifier displaying the maritime Automatic Identification System.	
T	Unique Designation (Track Number)	A text amplifier for units, equipment and installations that uniquely identifies a particular symbol or track number.	Prefix = TN:##### Example: TN:13579
V	Type	A text amplifier for equipment that indicates types of equipment.	

TABLE E-II. Descriptions and formats of sea surface symbol amplifiers - Continued.

FIELD	FIELD TITLE	DESCRIPTION	FORMAT
Y	Location	A text amplifier for units, equipment and installations that displays a symbol's location in degrees, minutes and seconds (or in UTM or other applicable display format).	
Z	Speed	A text amplifier for CBRN, units and equipment that displays velocity as set forth in MIL-STD- 6040 .	
AL	Operational Condition	A graphic amplifier for equipment or installations that indicates operational condition or capacity.	Operational Condition amplifier, if used, shall be comprised of only one color. Ex. Aircraft: Red - damaged, Green – fully capable Ex: Missile: Red – imminent threat, Green – no threat
AO	Engagement Bar	A graphic amplifier placed immediately atop the symbol. May denote, 1) local/remote status; 2) engagement status; and 3) weapon type.	A:BBB-CC, where A = remote/local BBB = engagement status CC = weapon asset
AQ	Guarded Unit	During ballistic missile defense, some tracks are designated as guarded by a particular unit.	The 2-character string, BG
AR	Special Designator	Special track designators, such as Non-Real Time (NRT) and Tactically Significant (SIG) tracks, are denoted here.	The 3-character strings, NRT or SIG

E.5.3.3.2 Graphic amplifiers. Graphic amplifiers can be static, located in a fixed position in relation to a track's symbol, or dynamic and move about the symbol based on the track's characteristics. [See 5.1.6](#) for more information on amplifiers, including examples of dynamic amplifiers.

E.6 SEA SURFACE UNIT, EQUIPMENT AND INSTALLATION SYMBOLS

E.6.1 Sea surface unit, equipment and installation symbols. This section includes the lists of icons and modifiers for building sea surface unit, equipment and installation symbols.

E.6.2 Sea surface unit, equipment and installation icons. [Table E-III](#) depicts sea surface unit, equipment and installation icons.

In accordance with [STANAG 1166, Standard Ship Designator System](#), single letter codes specify the type of merchant ship, while two- and three-letter codes specify the type of military ship. For other types of civilian surface vessels, the letter codes of the icon are without a STANAG reference. Military symbols are depicted with black-filled icons, whereas civilian symbols are depicted with white-filled icons.

TABLE E-III. Sea surface unit, equipment and installation icons.



DESCRIPTION	ICON	REMARKS
MILITARY Type: Entity Symbol Set Code: 30 Code: 110000 Icon Type: Main	 An octagonal icon with a blue border and three horizontal lines. The letters 'MIL' are written in bold black font across the middle.	This symbol shall not be displayed on a C2 system but may be displayed for training or hierarchal explanation purposes.
MILITARY COMBATANT Type: Entity Symbol Set Code: 30 Code: 120000 Icon Type: Main	 An octagonal icon with a blue border and three horizontal lines. A pair of scissors is depicted in the center.	This symbol shall not be displayed on a C2 system but may be displayed for training or hierarchal explanation purposes.
CARRIER Type: Entity Type Entity: MILITARY COMBATANT Symbol Set Code: 30 Code: 120100 Icon Type: Main	 An octagonal icon with a blue border and three horizontal lines. A solid black arrow points downwards from the top.	N/A
SURFACE COMBATANT, LINE Type: Entity Type Entity: MILITARY COMBATANT Symbol Set Code: 30 Code: 120200 Icon Type: Main	 An octagonal icon with a blue border and three horizontal lines. A solid black arrow points downwards from the top, with a small cross symbol at its base.	N/A
BATTLESHIP Type: Entity Subtype Entity/Entity Type: MILITARY COMBATANT/SURFACE COMBATANT, LINE Symbol Set Code: 30 Code: 120201 Icon Type: Main	 An octagonal icon with a blue border and three horizontal lines. The letters 'BB' are written in bold black font across the middle.	N/A

TABLE E-III. Sea surface unit, equipment and installation icons - Continued.



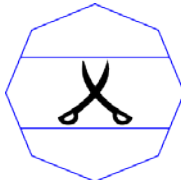
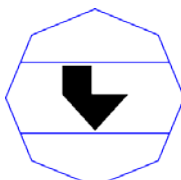
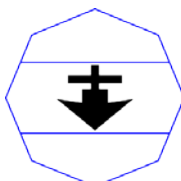

DESCRIPTION	ICON	REMARKS
CRUISER Type: Entity Subtype Entity/Entity Type: MILITARY COMBATANT/SURFACE COMBATANT, LINE Symbol Set Code: 30 Code: 120202 Icon Type: Main		N/A
DESTROYER Type: Entity Subtype Entity/Entity Type: MILITARY COMBATANT/SURFACE COMBATANT, LINE Symbol Set Code: 30 Code: 120203 Icon Type: Main		N/A
FRIGATE Type: Entity Subtype Entity/Entity Type: MILITARY COMBATANT/SURFACE COMBATANT, LINE Symbol Set Code: 30 Code: 120204 Icon Type: Main		N/A
CORVETTE Type: Entity Subtype Entity/Entity Type: MILITARY COMBATANT/SURFACE COMBATANT, LINE Symbol Set Code: 30 Code: 120205 Icon Type: Main		N/A
LITTORAL COMBATANT SHIP Type: Entity Subtype Entity/Entity Type: MILITARY COMBATANT/SURFACE COMBATANT, LINE Symbol Set Code: 30 Code: 120206 Icon Type: Main		N/A

TABLE E-III. Sea surface unit, equipment and installation icons - Continued.



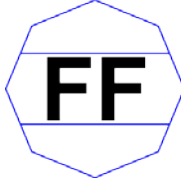

DESCRIPTION	ICON	REMARKS
AMPHIBIOUS WARFARE SHIP Type: Entity Type Entity: MILITARY COMBATANT Symbol Set Code: 30 Code: 120300 Icon Type: Main		N/A
AMPHIBIOUS COMMAND SHIP Type: Entity Subtype Entity/Entity Type: MILITARY COMBATANT/AMPHIBIOUS WARFARE SHIP Symbol Set Code: 30 Code: 120301 Icon Type: Main		N/A
AMPHIBIOUS ASSAULT, NON-SPECIFIED Type: Entity Subtype Entity/Entity Type: MILITARY COMBATANT/AMPHIBIOUS WARFARE SHIP Symbol Set Code: 30 Code: 120302 Icon Type: Main		N/A
AMPHIBIOUS ASSAULT SHIP, GENERAL Type: Entity Subtype Entity/Entity Type: MILITARY COMBATANT/AMPHIBIOUS WARFARE SHIP Symbol Set Code: 30 Code: 120303 Icon Type: Main		N/A
AMPHIBIOUS ASSAULT SHIP, MULTIPURPOSE Type: Entity Subtype Entity/Entity Type: MILITARY COMBATANT/AMPHIBIOUS WARFARE SHIP Symbol Set Code: 30 Code: 120304 Icon Type: Main		N/A

TABLE E-III. Sea surface unit, equipment and installation icons - Continued.

DESCRIPTION	ICON	REMARKS
<p>AMPHIBIOUS ASSAULT SHIP, HELICOPTER</p> <p>Type: Entity Subtype Entity/Entity Type: MILITARY COMBATANT/AMPHIBIOUS WARFARE SHIP Symbol Set Code: 30 Code: 120305 Icon Type: Main</p>		N/A
<p>AMPHIBIOUS TRANSPORT DOCK</p> <p>Type: Entity Subtype Entity/Entity Type: MILITARY COMBATANT/AMPHIBIOUS WARFARE SHIP Symbol Set Code: 30 Code: 120306 Icon Type: Main</p>		N/A
<p>LANDING SHIP</p> <p>Type: Entity Subtype Entity/Entity Type: MILITARY COMBATANT/AMPHIBIOUS WARFARE SHIP Symbol Set Code: 30 Code: 120307 Icon Type: Main</p>		N/A
<p>LANDING CRAFT</p> <p>Type: Entity Subtype Entity/Entity Type: MILITARY COMBATANT/AMPHIBIOUS WARFARE SHIP Symbol Set Code: 30 Code: 120308 Icon Type: Main</p>		N/A
<p>MINE WARFARE SHIP</p> <p>Type: Entity Type Entity: MILITARY COMBATANT Symbol Set Code: 30 Code: 120400 Icon Type: Main</p>		N/A

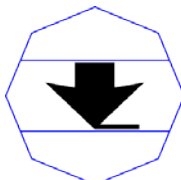
TABLE E-III. Sea surface unit, equipment and installation icons - Continued.





DESCRIPTION	ICON	REMARKS
MINE LAYER Type: Entity Subtype Entity/Entity Type: MILITARY COMBATANT/MINE WARFARE SHIP Symbol Set Code: 30 Code: 120401 Icon Type: Main		N/A
MINE SWEEPER Type: Entity Subtype Entity/Entity Type: MILITARY COMBATANT/MINE WARFARE SHIP Symbol Set Code: 30 Code: 120402 Icon Type: Main		N/A
MINE SWEEPER, DRONE Type: Entity Subtype Entity/Entity Type: MILITARY COMBATANT/MINE WARFARE SHIP Symbol Set Code: 30 Code: 120403 Icon Type: Main		N/A
MINE HUNTER Type: Entity Subtype Entity/Entity Type: MILITARY COMBATANT/MINE WARFARE SHIP Symbol Set Code: 30 Code: 120404 Icon Type: Main		N/A
MINE COUNTERMEASURES Type: Entity Subtype Entity/Entity Type: MILITARY COMBATANT/MINE WARFARE SHIP Symbol Set Code: 30 Code: 120405 Icon Type: Main		N/A

TABLE E-III. Sea surface unit, equipment and installation icons - Continued.



DESCRIPTION	ICON	REMARKS
MINE COUNTERMEASURES, SUPPORT SHIP Type: Entity Subtype Entity/Entity Type: MILITARY COMBATANT/MINE WARFARE SHIP Symbol Set Code: 30 Code: 120406 Icon Type: Main		N/A
PATROL BOAT Type: Entity Type Entity: MILITARY COMBATANT Symbol Set Code: 30 Code: 120500 Icon Type: Main		N/A
PATROL CRAFT, SUBMARINE CHASER/ESCORT, GENERAL Type: Entity Subtype Entity/Entity Type: MILITARY COMBATANT/PATROL BOAT Symbol Set Code: 30 Code: 120501 Icon Type: Main		N/A
PATROL SHIP, GENERAL Type: Entity Subtype Entity/Entity Type: MILITARY COMBATANT/PATROL BOAT Symbol Set Code: 30 Code: 120502 Icon Type: Main		N/A
DECOY Type: Entity Type Entity: MILITARY COMBATANT Symbol Set Code: 30 Code: 120600 Icon Type: Main		N/A
UNMANNED SURFACE WATER VEHICLE (USV) Type: Entity Type Entity: MILITARY COMBATANT Symbol Set Code: 30 Code: 120700 Icon Type: Main		N/A

TABLE E-III. Sea surface unit, equipment and installation icons - Continued.

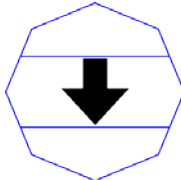

DESCRIPTION	ICON	REMARKS
<p>SPEEDBOAT</p> <p>Type: Entity Type Entity: MILITARY COMBATANT Symbol Set Code: 30 Code: 120800 Icon Type: Main</p>		<p>N/A</p>
<p>RIGID-HULL INFLATABLE BOAT (RHIB)</p> <p>Type: Entity Subtype Entity/Entity Type: MILITARY COMBATANT/SPEEDBOAT Symbol Set Code: 30 Code: 120801 Icon Type: Main</p>		<p>N/A</p>
<p>JET SKI</p> <p>Type: Entity Type Entity: MILITARY COMBATANT Symbol Set Code: 30 Code: 120900 Icon Type: Main</p>		<p>N/A</p>
<p>NAVY TASK ORGANIZATION</p> <p>Type: Entity Type Entity: MILITARY COMBATANT Symbol Set Code: 30 Code: 121000 Icon Type: Main</p>		<p>N/A</p>
<p>NAVY TASK ELEMENT</p> <p>Type: Entity Subtype Entity/Entity Type: MILITARY COMBATANT/NAVY TASK ORGANIZATION Symbol Set Code: 30 Code: 121001 Icon Type: Main</p>		<p>N/A</p>
<p>NAVY TASK FORCE</p> <p>Type: Entity Subtype Entity/Entity Type: MILITARY COMBATANT/NAVY TASK ORGANIZATION Symbol Set Code: 30 Code: 121002 Icon Type: Main</p>		<p>N/A</p>

TABLE E-III. Sea surface unit, equipment and installation icons - Continued.

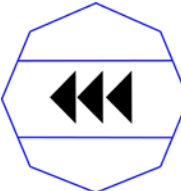
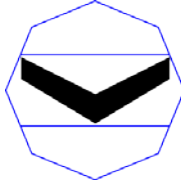
DESCRIPTION	ICON	REMARKS
NAVY TASK GROUP Type: Entity Subtype Entity/Entity Type: MILITARY COMBATANT/NAVY TASK ORGANIZATION Symbol Set Code: 30 Code: 121003 Icon Type: Main		N/A
NAVY TASK UNIT Type: Entity Subtype Entity/Entity Type: MILITARY COMBATANT/NAVY TASK ORGANIZATION Symbol Set Code: 30 Code: 121004 Icon Type: Main		N/A
CONVOY Type: Entity Subtype Entity/Entity Type: MILITARY COMBATANT/NAVY TASK ORGANIZATION Symbol Set Code: 30 Code: 121005 Icon Type: Main		N/A
SEA-BASED X-BAND (SBX) RADAR Type: Entity Type Entity: MILITARY COMBATANT Symbol Set Code: 30 Code: 121100 Icon Type: Main		N/A
MILITARY NONCOMBATANT Type: Entity Symbol Set Code: 30 Code: 130000 Icon Type: Main		This symbol shall not be displayed on a C2 system but may be displayed for training or hierarchal explanation purposes.
AUXILIARY SHIP Type: Entity Type Entity: MILITARY NONCOMBATANT Symbol Set Code: 30 Code: 130100 Icon Type: Main		N/A

TABLE E-III. Sea surface unit, equipment and installation icons - Continued.

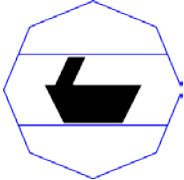

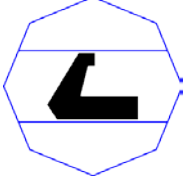
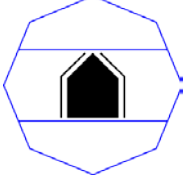
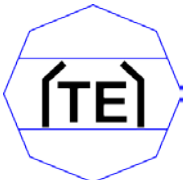
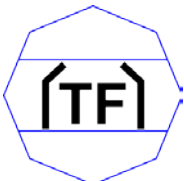

DESCRIPTION	ICON	REMARKS
AMMUNITION SHIP Type: Entity Subtype Entity/Entity Type: MILITARY NONCOMBATANT/AUXILIARY SHIP Symbol Set Code: 30 Code: 130101 Icon Type: Main		N/A
NAVAL STORES SHIP Type: Entity Subtype Entity/Entity Type: MILITARY NONCOMBATANT/AUXILIARY SHIP Symbol Set Code: 30 Code: 130102 Icon Type: Main		N/A
AUXILIARY FLAG SHIP Type: Entity Subtype Entity/Entity Type: MILITARY NONCOMBATANT/AUXILIARY SHIP Symbol Set Code: 30 Code: 130103 Icon Type: Main		N/A
INTELLIGENCE COLLECTOR Type: Entity Subtype Entity/Entity Type: MILITARY NONCOMBATANT/AUXILIARY SHIP Symbol Set Code: 30 Code: 130104 Icon Type: Main		N/A
OCEANOGRAPHIC RESEARCH SHIP Type: Entity Subtype Entity/Entity Type: MILITARY NONCOMBATANT/AUXILIARY SHIP Symbol Set Code: 30 Code: 130105 Icon Type: Main		N/A

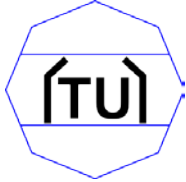
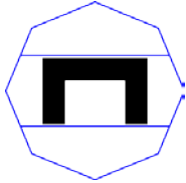
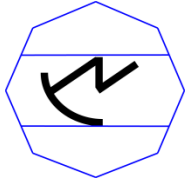
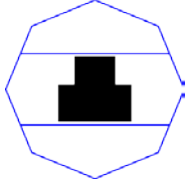
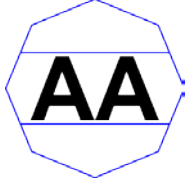
TABLE E-III. Sea surface unit, equipment and installation icons - Continued.





DESCRIPTION	ICON	REMARKS
SURVEY SHIP Type: Entity Subtype Entity/Entity Type: MILITARY NONCOMBATANT/AUXILIARY SHIP Symbol Set Code: 30 Code: 130106 Icon Type: Main		N/A
HOSPITAL SHIP Type: Entity Subtype Entity/Entity Type: MILITARY NONCOMBATANT/AUXILIARY SHIP Symbol Set Code: 30 Code: 130107 Icon Type: Main		N/A
NAVAL CARGO SHIP Type: Entity Subtype Entity/Entity Type: MILITARY NONCOMBATANT/AUXILIARY SHIP Symbol Set Code: 30 Code: 130108 Icon Type: Main		N/A
COMBAT SUPPORT SHIP, FAST Type: Entity Subtype Entity/Entity Type: MILITARY NONCOMBATANT/AUXILIARY SHIP Symbol Set Code: 30 Code: 130109 Icon Type: Main		N/A
OILER, REPLENISHMENT Type: Entity Subtype Entity/Entity Type: MILITARY NONCOMBATANT/AUXILIARY SHIP Symbol Set Code: 30 Code: 130110 Icon Type: Main		N/A

TABLE E-III. Sea surface unit, equipment and installation icons - Continued.





DESCRIPTION	ICON	REMARKS
REPAIR SHIP Type: Entity Subtype Entity/Entity Type: MILITARY NONCOMBATANT/AUXILIARY SHIP Symbol Set Code: 30 Code: 130111 Icon Type: Main		N/A
SUBMARINE TENDER Type: Entity Subtype Entity/Entity Type: MILITARY NONCOMBATANT/AUXILIARY SHIP Symbol Set Code: 30 Code: 130112 Icon Type: Main		N/A
TUG, OCEAN GOING Type: Entity Subtype Entity/Entity Type: MILITARY NONCOMBATANT/AUXILIARY SHIP Symbol Set Code: 30 Code: 130113 Icon Type: Main		N/A
SERVICE CRAFT/YARD Type: Entity Type Entity: MILITARY NONCOMBATANT Symbol Set Code: 30 Code: 130200 Icon Type: Main		N/A
BARGE, NOT SELF-PROPELLED Type: Entity Subtype Entity/Entity Type: MILITARY NONCOMBATANT/SERVICE CRAFT/YARD Symbol Set Code: 30 Code: 130201 Icon Type: Main		N/A

TABLE E-III. Sea surface unit, equipment and installation icons - Continued.



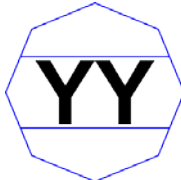

DESCRIPTION	ICON	REMARKS
<p>BARGE, SELF-PROPELLED</p> <p>Type: Entity Subtype Entity/Entity Type: MILITARY NONCOMBATANT/SERVICE CRAFT/YARD Symbol Set Code: 30 Code: 130202 Icon Type: Main</p>		<p>N/A</p>
<p>TUG, HARBOR</p> <p>Type: Entity Subtype Entity/Entity Type: MILITARY NONCOMBATANT/SERVICE CRAFT/YARD Symbol Set Code: 30 Code: 130203 Icon Type: Main</p>		<p>N/A</p>
<p>LAUNCH</p> <p>Type: Entity Subtype Entity/Entity Type: MILITARY NONCOMBATANT/SERVICE CRAFT/YARD Symbol Set Code: 30 Code: 130204 Icon Type: Main</p>		<p>N/A</p>
<p>CIVILIAN</p> <p>Type: Entity Symbol Set Code: 30 Code: 140000 Icon Type: Main</p>		<p>N/A</p>
<p>MERCHANT SHIP</p> <p>Type: Entity Type Entity: CIVILIAN Symbol Set Code: 30 Code: 140100 Icon Type: Full Octagon</p>		<p>N/A</p>
<p>CARGO, GENERAL</p> <p>Type: Entity Subtype Entity/Entity Type: CIVILIAN/MERCHANT SHIP Symbol Set Code: 30 Code: 140101 Icon Type: Full Octagon</p>		<p>N/A</p>

TABLE E-III. Sea surface unit, equipment and installation icons - Continued.

DESCRIPTION	ICON	REMARKS
CONTAINER SHIP Type: Entity Subtype Entity/Entity Type: CIVILIAN/MERCHANT SHIP Symbol Set Code: 30 Code: 140102 Icon Type: Full Octagon		N/A
DREDGE Type: Entity Subtype Entity/Entity Type: CIVILIAN/MERCHANT SHIP Symbol Set Code: 30 Code: 140103 Icon Type: Full Octagon		N/A
ROLL ON/ROLL OFF Type: Entity Subtype Entity/Entity Type: CIVILIAN/MERCHANT SHIP Symbol Set Code: 30 Code: 140104 Icon Type: Full Octagon		N/A
FERRY Type: Entity Subtype Entity/Entity Type: CIVILIAN/MERCHANT SHIP Symbol Set Code: 30 Code: 140105 Icon Type: Full Octagon		N/A
HEAVY LIFT Type: Entity Subtype Entity/Entity Type: CIVILIAN/MERCHANT SHIP Symbol Set Code: 30 Code: 140106 Icon Type: Full Octagon		N/A
HOVERCRAFT Type: Entity Subtype Entity/Entity Type: CIVILIAN/MERCHANT SHIP Symbol Set Code: 30 Code: 140107 Icon Type: Full Octagon		N/A

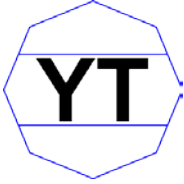
TABLE E-III. Sea surface unit, equipment and installation icons - Continued.

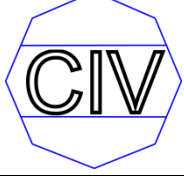
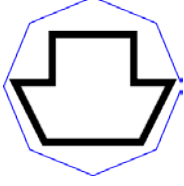



DESCRIPTION	ICON	REMARKS
LASH CARRIER (WITH BARGES) Type: Entity Subtype Entity/Entity Type: CIVILIAN/MERCHANT SHIP Symbol Set Code: 30 Code: 140108 Icon Type: Full Octagon		N/A
OILER/TANKER Type: Entity Subtype Entity/Entity Type: CIVILIAN/MERCHANT SHIP Symbol Set Code: 30 Code: 140109 Icon Type: Full Octagon		N/A
PASSENGER Type: Entity Subtype Entity/Entity Type: CIVILIAN/MERCHANT SHIP Symbol Set Code: 30 Code: 140110 Icon Type: Full Octagon		N/A
TUG, OCEAN GOING Type: Entity Subtype Entity/Entity Type: CIVILIAN/MERCHANT SHIP Symbol Set Code: 30 Code: 140111 Icon Type: Full Octagon		N/A
TOW Type: Entity Subtype Entity/Entity Type: CIVILIAN/MERCHANT SHIP Symbol Set Code: 30 Code: 140112 Icon Type: Full Octagon		N/A
TRANSPORT SHIP, HAZARDOUS MATERIAL Type: Entity Subtype Entity/Entity Type: CIVILIAN/MERCHANT SHIP Symbol Set Code: 30 Code: 140113 Icon Type: Full Octagon		N/A

TABLE E-III. Sea surface unit, equipment and installation icons - Continued.





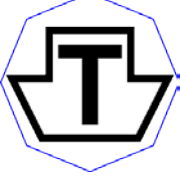

DESCRIPTION	ICON	REMARKS
JUNK/DHOW Type: Entity Subtype Entity/Entity Type: CIVILIAN/MERCHANT SHIP Symbol Set Code: 30 Code: 140114 Icon Type: Full Octagon		N/A
BARGE, NOT SELF-PROPELLED Type: Entity Subtype Entity/Entity Type: CIVILIAN/MERCHANT SHIP Symbol Set Code: 30 Code: 140115 Icon Type: Full Octagon		N/A
HOSPITAL SHIP Type: Entity Subtype Entity/Entity type: CIVILIAN/MERCHANT SHIP Symbol Set Code: 30 Code: 140116 Icon Type: Full Octagon		N/A
FISHING VESSEL Type: Entity Type Entity: CIVILIAN Symbol Set Code: 30 Code: 140200 Icon Type: Full Octagon		N/A
DRIFTER Type: Entity Subtype Entity/Entity Type: CIVILIAN/FISHING VESSEL Symbol Set Code: 30 Code: 140201 Icon Type: Full Octagon		N/A
TRAWLER Type: Entity Subtype Entity/Entity Type: CIVILIAN/FISHING VESSEL Symbol Set Code: 30 Code: 140202 Icon Type: Full Octagon		N/A

TABLE E-III. Sea surface unit, equipment and installation icons - Continued.

DESCRIPTION	ICON	REMARKS
DREDGER Type: Entity Subtype Entity/Entity Type: CIVILIAN/FISHING VESSEL Symbol Set Code: 30 Code: 140203 Icon Type: Full Octagon		N/A
LAW ENFORCEMENT VESSEL Type: Entity Type Entity: CIVILIAN Symbol Set Code: 30 Code: 140300 Icon Type: Full Octagon		N/A
LEISURE CRAFT, SAILING Type: Entity Type Entity: CIVILIAN Symbol Set Code: 30 Code: 140400 Icon Type: Full Octagon		N/A
LEISURE CRAFT, MOTORIZED Type: Entity Type Entity: CIVILIAN Symbol Set Code: 30 Code: 140500 Icon Type: Full Octagon		N/A
RIGID-HULL INFLATABLE BOAT (RHIB) Type: Entity Subtype Entity/Entity Type: CIVILIAN/LEISURE CRAFT, MOTORIZED Symbol Set Code: 30 Code: 140501 Icon Type: Full Octagon		N/A
SPEEDBOAT Type: Entity Subtype Entity/Entity Type: CIVILIAN/LEISURE CRAFT, MOTORIZED Symbol Set Code: 30 Code: 140502 Icon Type: Full Octagon		N/A

TABLE E-III. Sea surface unit, equipment and installation icons - Continued.

DESCRIPTION	ICON	REMARKS
JET SKI Type: Entity Type Entity: CIVILIAN Symbol Set Code: 30 Code: 140600 Icon Type: Full Octagon		N/A
UNMANNED SURFACE WATER VEHICLE (USV) Type: Entity Type Entity: CIVILIAN Symbol Set Code: 30 Code: 140700 Icon Type: Full Octagon		N/A

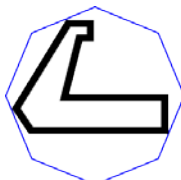
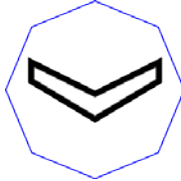
E.6.3 Sea surface unit, equipment and installation sector 1 modifiers. Sea surface unit, equipment and installation sector 1 modifiers denote mission area, weapons capability and asset capability categories. Modifiers are not permitted with civilian sea surface symbols. [Table E-IV](#) lists sea surface unit, equipment and installation sector 1 modifiers and illustrates their placement within the bounding octagon.

TABLE E-IV. Sea surface unit, equipment and installation sector 1 modifiers.



DESCRIPTION	CATEGORY	MODIFIER	REMARKS
OWN SHIP Symbol Set Code: 30 Code: 01	MISSION AREA		APP-6
ANTI-AIR WARFARE Symbol Set Code: 30 Code: 02	MISSION AREA		N/A
ANTISUBMARINE WARFARE Symbol Set Code: 30 Code: 03	MISSION AREA		N/A
ESCORT Symbol Set Code: 30 Code: 04	MISSION AREA		N/A

TABLE E-IV. Sea surface unit, equipment and installation sector 1 modifiers - Continued.

DESCRIPTION	CATEGORY	MODIFIER	REMARKS
ELECTRONIC WARFARE Symbol Set Code: 30 Code: 05	MISSION AREA		N/A
INTELLIGENCE, SURVEILLANCE, RECONNAISSANCE Symbol Set Code: 30 Code: 06	MISSION AREA		N/A
MINE COUNTERMEASURES Symbol Set Code: 30 Code: 07	MISSION AREA		N/A
MISSILE DEFENSE Symbol Set Code: 30 Code: 08	MISSION AREA		N/A
MEDICAL Symbol Set Code: 30 Code: 09	MISSION AREA		N/A
MINE WARFARE Symbol Set Code: 30 Code: 10	MISSION AREA		N/A
REMOTE MULTIMISSION VEHICLE (RMV) Symbol Set Code: 30 Code: 11	MISSION AREA		US only
SPECIAL OPERATIONS FORCES (SOF) Symbol Set Code: 30 Code: 12	ASSET CAPABILITY		N/A

MIL-STD-2525D - APPENDIX E

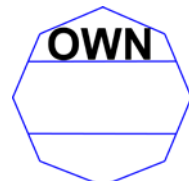
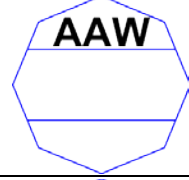
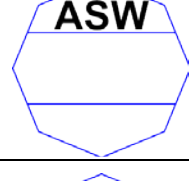
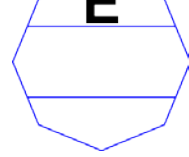
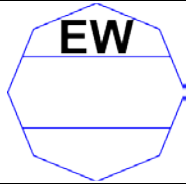
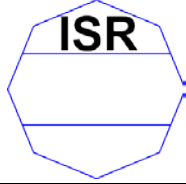
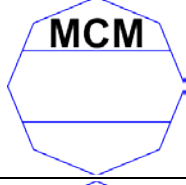
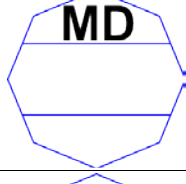
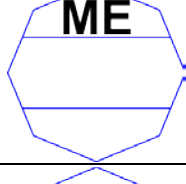
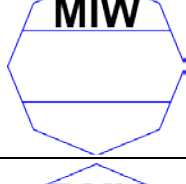
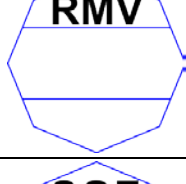
TABLE E-IV. Sea surface unit, equipment and installation sector 1 modifiers - Continued.

DESCRIPTION	CATEGORY	MODIFIER	REMARKS
SURFACE WARFARE Symbol Set Code: 30 Code: 13	MISSION AREA		N/A
BALLISTIC MISSILE Symbol Set Code: 30 Code: 14	WEAPONS CAPABILITY		N/A
GUIDED MISSILE Symbol Set Code: 30 Code: 15	WEAPONS CAPABILITY		N/A
OTHER GUIDED MISSILE Symbol Set Code: 30 Code: 16	WEAPONS CAPABILITY		N/A
TORPEDO Symbol Set Code: 30 Code: 17	WEAPONS CAPABILITY		N/A
DRONE EQUIPPED Symbol Set Code: 30 Code: 18	ASSET CAPABILITY		N/A
HELICOPTER EQUIPPED/VSTOL Symbol Set Code: 30 Code: 19	ASSET CAPABILITY		N/A
BALLISTIC MISSILE DEFENSE, SHOOTER Symbol Set Code: 30 Code: 20	MISSION AREA		N/A

TABLE E-IV. Sea surface unit, equipment and installation sector 1 modifiers - Continued.

DESCRIPTION	CATEGORY	MODIFIER	REMARKS
BALLISTIC MISSILE DEFENSE, LONG-RANGE SURVEILLANCE AND TRACK (LRS&T) Symbol Set Code: 30 Code: 21	MISSION AREA		N/A
SEA-BASE X-BAND Symbol Set Code: 30 Code: 22	MISSION AREA		Used with SBX Radar (Code: 121100) only
HIJACKING/HIJACKED Symbol Set Code: 30 Code: 23	CRIME		N/A

E.6.4 Sea surface unit, equipment and installation sector 2 modifiers. Sea surface unit, equipment and installation sector 2 modifiers denote ship propulsion, ship capacity, cargo capacity, ship mobility and USV control categories. Modifiers are not permitted with civilian sea surface symbols. [Table E-V](#) lists sea surface unit, equipment and installation sector 2 modifiers and illustrates their placement within the bounding octagon.

TABLE E-V. Sea surface unit, equipment and installation sector 2 modifiers.

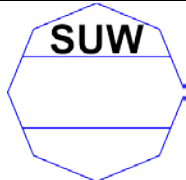
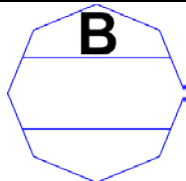
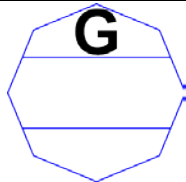
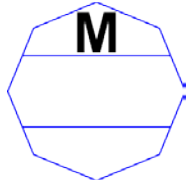
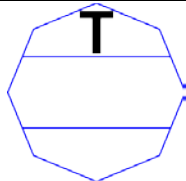
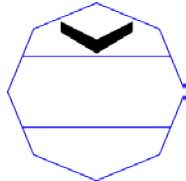
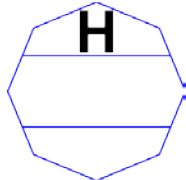
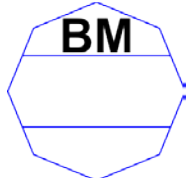
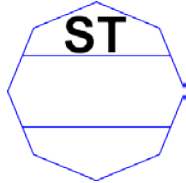
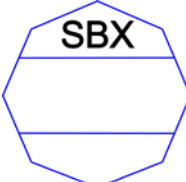
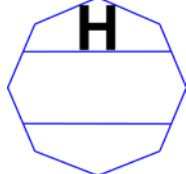
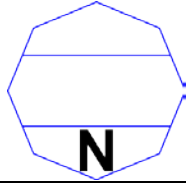
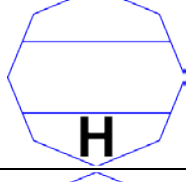
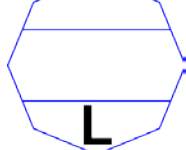
DESCRIPTION	CATEGORY	MODIFIER	REMARKS
NUCLEAR POWERED Symbol Set Code: 30 Code: 01	SHIP PROPULSION		N/A
HEAVY Symbol Set Code: 30 Code: 02	SHIP CAPACITY		N/A
LIGHT Symbol Set Code: 30 Code: 03	SHIP CAPACITY		N/A

MIL-STD-2525D - APPENDIX E

TABLE E-V. Sea surface unit, equipment and installation sector 2 modifiers - Continued.

DESCRIPTION	CATEGORY	MODIFIER	REMARKS
MEDIUM Symbol Set Code: 30 Code: 04	SHIP CAPACITY		N/A
DOCK Symbol Set Code: 30 Code: 05	CARGO CAPACITY		N/A
LOGISTICS Symbol Set Code: 30 Code: 06	CARGO CAPACITY		N/A
TANK Symbol Set Code: 30 Code: 07	CARGO CAPACITY		N/A
VEHICLE Symbol Set Code: 30 Code: 08	CARGO CAPACITY		N/A
FAST Symbol Set Code: 30 Code: 09	SHIP MOBILITY		N/A
AIR-CUSHIONED (US) Symbol Set Code: 30 Code: 10	SHIP MOBILITY		N/A
AIR-CUSHIONED (NATO) Symbol Set Code: 30 Code: 11	SHIP MOBILITY		N/A

TABLE E-V. Sea surface unit, equipment and installation sector 2 modifiers - Continued.

DESCRIPTION	CATEGORY	MODIFIER	REMARKS
HYDROFOIL Symbol Set Code: 30 Code: 12	SHIP MOBILITY		N/A
AUTONOMOUS CONTROL Symbol Set Code: 30 Code: 13	USV CONTROL		Used with USV only.
REMOTELY PILOTED Symbol Set Code: 30 Code: 14	USV CONTROL		Used with USV only.
EXPENDABLE Symbol Set Code: 30 Code: 15	USV CONTROL		Used with USV only.

E.6.5 Sea surface local tracks. Local tracks are tracks internal to a particular Combat Information Center (CIC). These tracks are not intended to be transmitted outside the ship's CIC. [Table E-VII](#) depicts local tracks. Modifiers are not permitted with local track symbols.

E.6.5.1 Fused tracks. Fused tracks are tracks in the process of classification. Multiple sources of incoming information need to be adjudicated and combined (fused) into a single track. Fused tracks are denoted by a question mark (“?”) encapsulated within an hourglass icon ([see table E-VII](#)). All fused tracks have a pending standard identity frame.

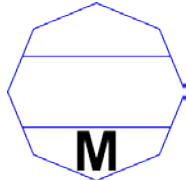
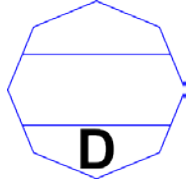
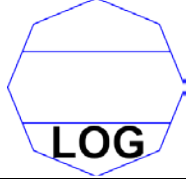
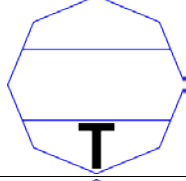
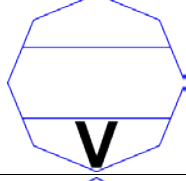
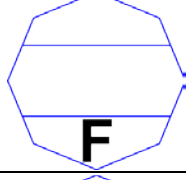
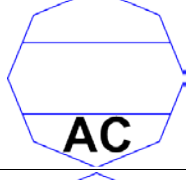
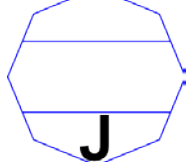
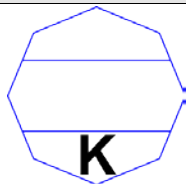
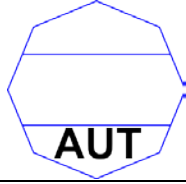
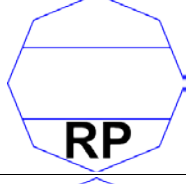
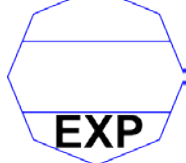
TABLE E-VI. Own Ship.



DESCRIPTION	ICON	REMARKS
OWN SHIP Type: Entity (Local) Symbol Set Code: 30 Code: 150000 Icon Type: Full Octagon		The diameter of the icon shall be 1L. This icon shall be used with a friend standard identity only.

TABLE E-VII. Sea surface local tracks.

DESCRIPTION	ICON	REMARKS
FUSED TRACK Type: Entity (Local) Symbol Set Code: 30 Code: 160000 Icon Type: Full Octagon		All fused tracks shall have a pending standard identity frame.
MANUAL TRACK Type: Entity (Local) Symbol Set Code: 30 Code: 170000 Icon Type: Full Octagon		N/A

PAGE INTENTIONALLY LEFT BLANK

APPENDIX F - SUBSURFACE SYMBOLS

F.1 SCOPE

F.1.1 Scope. This appendix addresses symbols that support subsurface units, equipment and installations in the C2 domain. The tables in this appendix present the icons and modifiers for the subsurface domain. This appendix is divided into two sections ([see figure F-1](#)): 1) unit, equipment and installation symbols ([see section F.6](#)) and 2) mine warfare symbols ([see section F.7](#)). This appendix is a mandatory part of the standard. The information contained herein is intended for compliance.

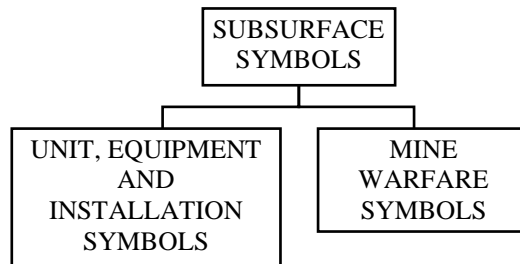

FIGURE F-1. Subsurface appendix sections.

F.2 APPLICABLE DOCUMENTS

Specific documents in [2.2](#) of this standard apply to this appendix.

F.3 DEFINITIONS

The definitions in [section 3](#) of this standard apply to this appendix.

F.4 GENERAL REQUIREMENTS

F.4.1 Organization. This appendix contains technical specifications, a symbol coding scheme, a symbology hierarchy and subsurface symbology.

F.5 DETAILED REQUIREMENTS

F.5.1 Technical specifications. Composition, construction and display of symbols are explained in the detailed requirements section of the standard.

F.5.2 Symbol identification coding scheme. A symbol identification code (SIDC) is a numeric string that may be used to provide the unique identifier necessary to display or exchange symbol information between MIL-STD-2525 compliant systems. Refer to [Appendix A](#) for SIDC positions and descriptions.

F.5.3 Composition of subsurface symbols. A standard method for constructing symbols is presented. Refer to [5.3.8](#) for an explanation of symbol composition. [Figure F-2](#) shows an example of a subsurface equipment symbol.

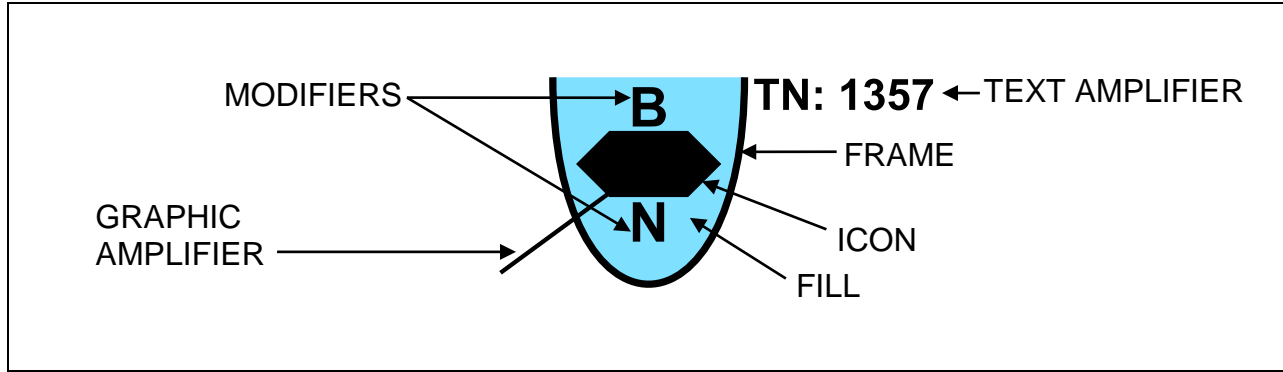

FIGURE F-2. Subsurface symbol components.

F.5.3.1 Symbol building process. [Table F-I](#) depicts the symbol building process for subsurface symbols. The process is identical for icons and modifiers requiring the vertical bounding octagon.

TABLE F-I. Subsurface symbol building process.

STEP	DESCRIPTION	EXAMPLE
1.	Choose the frame that matches the standard identity of the object from the subsurface column in tables I, II, or III. In this example, the standard identity is friend. The example depicts a “friendly subsurface track.”	
2.	Choose an icon for the main sector of the bounding octagon. In this example, the icon is “submarine,” a subsurface entity type. The example depicts a “friendly submarine.”	
3.	If required, choose a modifier to depict an additional characteristic of the icon. In this example, the modifier is “ballistic missile,” a sector 1 modifier. The example depicts a “friendly submarine with ballistic missile weapons capability.”	

TABLE F-I. Subsurface symbol building process - Continued.

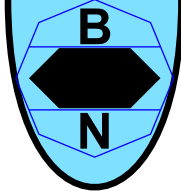
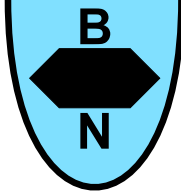
STEP	DESCRIPTION	EXAMPLE
4.	<p>If required, choose a modifier to depict another characteristic of the icon. In this example, the modifier is “nuclear powered,” a sector 2 modifier.</p> <p>The example depicts a “friendly nuclear powered submarine with ballistic missile weapons capability.”</p>	
5.	<p>The finished symbol will appear as shown in the example.</p>	

F.5.3.2 Icons and modifiers. All icons shall be placed within the main sector of the bounding octagon or fill the octagon, as indicated in [table F-III](#). When depicted, modifiers shall be placed in sectors 1 or 2 as appropriate ([see table F-I](#)). Only one modifier may be placed in each sector at a given time. Multiple modifiers in the same position are prohibited due to legibility concerns.

F.5.3.3 Amplifiers.

F.5.3.3.1 Text amplifiers. The purpose of the static text amplifiers described in this appendix is to standardize the display of additional alphanumeric information on identity, movement and location and capabilities. [See 5.1.6](#) for more information on amplifiers. [Figure F-3](#) shows the placement of subsurface symbol amplifiers around the friend symbol frame. [Table F-II](#) provides descriptions and formats of each amplifier.

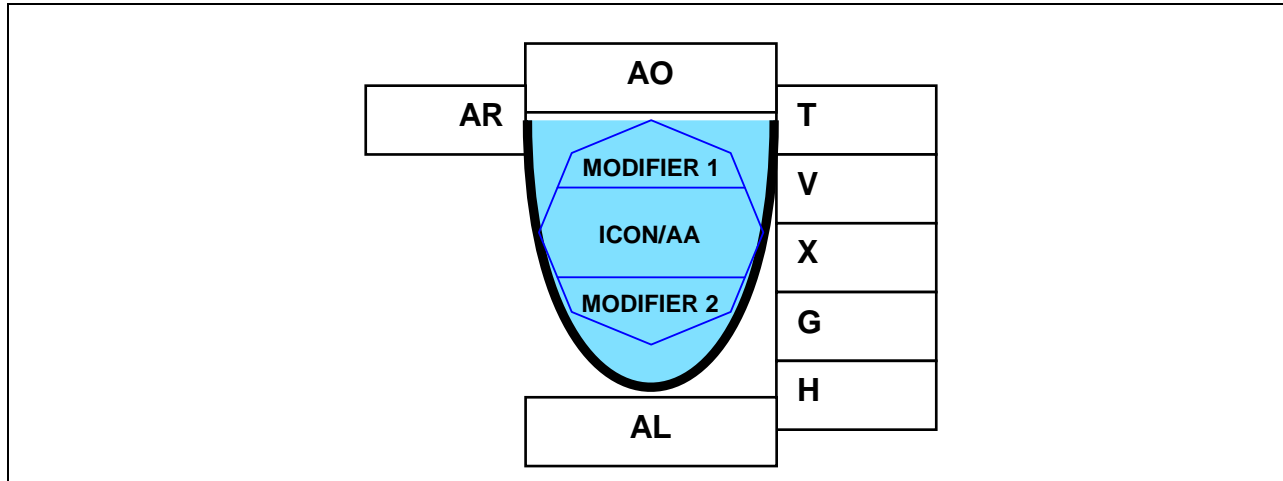

FIGURE F-3. Placement of subsurface symbol amplifiers.

TABLE F-II. Descriptions and formats of subsurface symbol amplifiers.

FIELD	FIELD TITLE	DESCRIPTION	FORMAT
A	Sub/Sub Type Icon	Uses icon and sector modifiers	
G	Staff Comments	A text amplifier for units, equipment and installations; content is implementation specific.	
H	Additional Information	A text amplifier for units, equipment and installations; content is implementation specific.	
T	Unique Designation (Track Number)	A text amplifier for units, equipment and installations that uniquely identifies a particular symbol or track number.	Prefix = TN:##### Example: TN:13579
V	Type	A text amplifier for equipment that indicates types of equipment.	
X	Depth	A text amplifier for equipment that displays depth for submerged objects.	Measurement units (FT, M) shall be displayed within the string. Ex: 105 FT
AL	Operational Condition	A graphic amplifier for equipment or installations that indicates operational condition or capacity.	Operational Condition amplifier, if used, shall be comprised of only one color. Ex. Aircraft: Red - damaged, Green – fully capable Ex: Missile: Red – imminent threat, Green – no threat
AO	Engagement Bar	A graphic amplifier placed immediately atop the symbol. May denote, 1) local/remote status; 2) engagement status; and 3) weapon type.	A:BBB-CC, where A = remote/local BBB = engagement status CC = weapon asset
AR	Special Designator	Special track designators such as Non-Real Time (NRT) and Tactically Significant (SIG) tracks are denoted here.	The 3-character strings, NRT or SIG

F.5.3.3.2 Graphic amplifiers. Graphic amplifiers can be static, located in a fixed position in relation to a track’s symbol, or dynamic and move about the symbol based on the track’s characteristics. [See 5.1.6](#) for more information on amplifiers, including examples of dynamic amplifiers.

F.6 SUBSURFACE UNIT, EQUIPMENT AND INSTALLATION SYMBOLS

F.6.1 Subsurface unit, equipment and installation symbols. This section includes the lists of icons and modifiers for building subsurface unit, equipment and installation symbols.

F.6.2 Subsurface unit, equipment and installation icons. [Table F-III](#) depicts subsurface unit, equipment and installation icons. Military symbols are depicted with black-filled icons, whereas civilian symbols are depicted with white-filled icons. Sea mines and sea mine decoys are presented in [section F.7](#).

TABLE F-III. Subsurface unit, equipment and installation icons.

DESCRIPTION	ICON	REMARKS
MILITARY Type: Entity Symbol Set Code: 35 Code: 110000 Icon Type: Main		N/A
SUBMARINE Type: Entity Type Entity: MILITARY Symbol Set Code: 35 Code: 110100 Icon Type: Main		N/A
SUBMARINE, SURFACED Type: Entity Subtype Entity/Entity Type: MILITARY/SUBMARINE Symbol Set Code: 35 Code: 110101 Icon Type: Main		N/A
SUBMARINE, SNORKELING Type: Entity Subtype Entity/Entity Type: MILITARY/SUBMARINE Symbol Set Code: 35 Code: 110102 Icon Type: Main		N/A

TABLE F-III. Subsurface unit, equipment and installation icons - Continued.







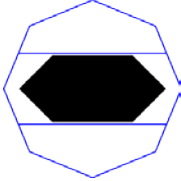
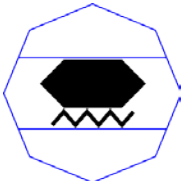
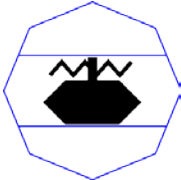

DESCRIPTION	ICON	REMARKS
SUBMARINE, BOTTOMED Type: Entity Subtype Entity/Entity Type: MILITARY/SUBMARINE Symbol Set Code: 35 Code: 110103 Icon Type: Main		N/A
OTHER SUBMERSIBLE Type: Entity Type Entity: MILITARY Symbol Set Code: 35 Code: 110200 Icon Type: Main		N/A
NONSUBMARINE Type: Entity Type Entity: MILITARY Symbol Set Code: 35 Code: 110300 Icon Type: Full Octagon		N/A
AUTONOMOUS UNDERWATER VEHICLE (AUV)/UNMANNED UNDERWATER VEHICLE (UUV) Type: Entity Type Entity: MILITARY Symbol Set Code: 35 Code: 110400 Icon Type: Main		N/A
DIVER Type: Entity Type Entity: MILITARY Symbol Set Code: 35 Code: 110500 Icon Type: Main		N/A
CIVILIAN Type: Entity Symbol Set Code: 35 Code: 120000 Icon Type: Main		N/A
SUBMERSIBLE Type: Entity Type Entity: CIVILIAN Symbol Set Code: 35 Code: 120100 Icon Type: Main		N/A

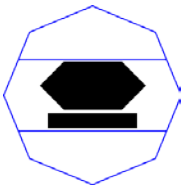
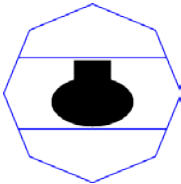
TABLE F-III. Subsurface unit, equipment and installation icons - Continued.

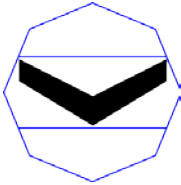
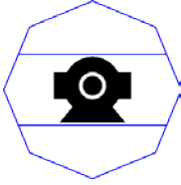
DESCRIPTION	ICON	REMARKS
AUTONOMOUS UNDERWATER VEHICLE (AUV)/UNMANNED UNDERWATER VEHICLE (UUV) Type: Entity Type Entity: CIVILIAN Symbol Set Code: 35 Code: 120200 Icon Type: Full Octagon		N/A
DIVER Type: Entity Type Entity: CIVILIAN Symbol Set Code: 35 Code: 120300 Icon Type: Main		N/A
WEAPON Type: Entity Symbol Set Code: 35 Code: 130000 Icon Type: Main		N/A
TORPEDO Type: Entity Type Entity: WEAPON Symbol Set Code: 35 Code: 130100 Icon Type: Main		N/A
IMPROVISED EXPLOSIVE DEVICE (IED) Type: Entity Type Entity: WEAPON Symbol Set Code: 35 Code: 130200 Icon Type: Main		Used with hostile standard identity only.
DECOY Type: Entity Type Entity: WEAPON Symbol Set Code: 35 Code: 130300 Icon Type: Main		N/A

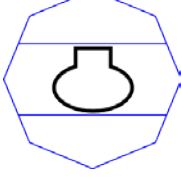
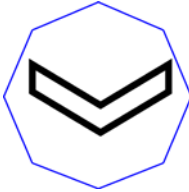
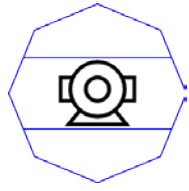
F.6.3 Subsurface unit, equipment and installation sector 1 modifiers. Subsurface unit, equipment and installation sector 1 modifiers denote mission area, weapons capability, asset capability and submarine confidence categories. [Table F-IV](#) lists subsurface unit, equipment and installation sector 1 modifiers and illustrates their placement within the bounding octagon.

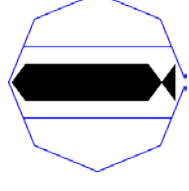
TABLE F-IV. Subsurface unit, equipment and installation sector 1 modifiers.

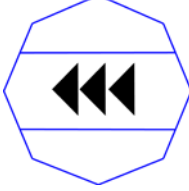
DESCRIPTION	CATEGORY	MODIFIER	REMARKS
ANTISUBMARINE WARFARE Symbol Set Code: 35 Code: 01	MISSION AREA		N/A
AUXILIARY Symbol Set Code: 35 Code: 02	MISSION AREA		Used with SUBMARINE entity type only.
COMMAND AND CONTROL Symbol Set Code: 35 Code: 03	MISSION AREA		Used with SUBMARINE entity type only.
INTELLIGENCE, SURVEILLANCE, RECONNAISSANCE Symbol Set Code: 35 Code: 04	MISSION AREA		N/A
MINE COUNTERMEASURES Symbol Set Code: 35 Code: 05	MISSION AREA		N/A
MINE WARFARE Symbol Set Code: 35 Code: 06	MISSION AREA		N/A
SURFACE WARFARE Symbol Set Code: 35 Code: 07	MISSION AREA		N/A

TABLE F-IV. Subsurface unit, equipment and installation sector 1 modifiers - Continued.



DESCRIPTION	CATEGORY	MODIFIER	REMARKS
ATTACK Symbol Set Code: 35 Code: 08	WEAPONS CAPABILITY		Used with SUBMARINE entity type only.
BALLISTIC MISSILE Symbol Set Code: 35 Code: 09	WEAPONS CAPABILITY		Used with SUBMARINE entity type only.
GUIDED MISSILE Symbol Set Code: 35 Code: 10	WEAPONS CAPABILITY		Used with SUBMARINE entity type only.
OTHER GUIDED MISSILE Symbol Set Code: 35 Code: 11	WEAPONS CAPABILITY		Used with SUBMARINE entity type only.
SPECIAL OPERATIONS FORCES (SOF) Symbol Set Code: 35 Code: 12	ASSET CAPABILITY		Used with SUBMARINE entity type only.
POSSIBLE SUBMARINE - LOW 1 Symbol Set Code: 35 Code: 13	SUBMARINE CONFIDENCE		Used with SUBMARINE entity type only.
POSSIBLE SUBMARINE - LOW 2 Symbol Set Code: 35 Code: 14	SUBMARINE CONFIDENCE		Used with SUBMARINE entity type only.
POSSIBLE SUBMARINE - HIGH 3 Symbol Set Code: 35 Code: 15	SUBMARINE CONFIDENCE		Used with SUBMARINE entity type only.

TABLE F-IV. Subsurface unit, equipment and installation sector 1 modifiers - Continued.

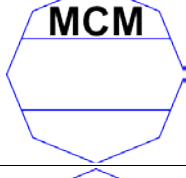
DESCRIPTION	CATEGORY	MODIFIER	REMARKS
POSSIBLE SUBMARINE - HIGH 4 Symbol Set Code: 35 Code: 16	SUBMARINE CONFIDENCE		Used with SUBMARINE entity type only.
PROBABLE SUBMARINE Symbol Set Code: 35 Code: 17	SUBMARINE CONFIDENCE		Used with SUBMARINE entity type only.
CERTAIN SUBMARINE Symbol Set Code: 35 Code: 18	SUBMARINE CONFIDENCE		Used with SUBMARINE entity type only.
ANTI-TORPEDO TORPEDO Symbol Set Code: 35 Code: 19	WEAPONS CAPABILITY		Used with TORPEDO entity type only.
HIJACKING/HIJACKED Symbol Set Code: 35 Code: 20	CRIME		N/A

F.6.4 Subsurface unit, equipment and installation sector 2 modifiers. Subsurface unit, equipment and installation sector 2 modifiers denote ship propulsion and UUV control categories. [Table F-V](#) lists subsurface unit, equipment and installation sector 2 modifiers and illustrates their placement within the bounding octagon.

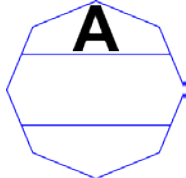
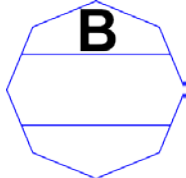
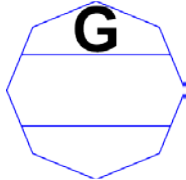
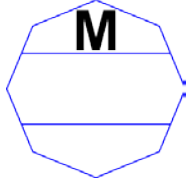
TABLE F-V. Subsurface unit, equipment and installation sector 2 modifiers.

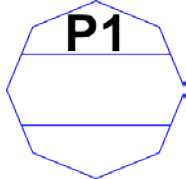
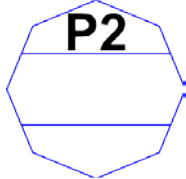
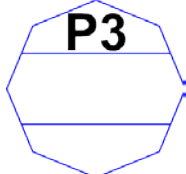
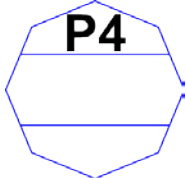
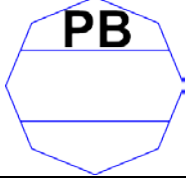
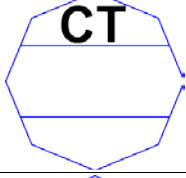
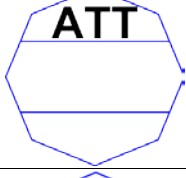
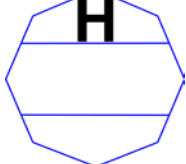
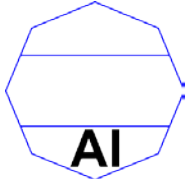
DESCRIPTION	CATEGORY	MODIFIER	REMARKS
AIR INDEPENDENT PROPULSION Symbol Set Code: 35 Code: 01	SHIP PROPULSION		Used with SUBMARINE entity type only.

MIL-STD-2525D - APPENDIX F

TABLE F-V. Subsurface unit, equipment and installation sector 2 modifiers - Continued.





DESCRIPTION	CATEGORY	MODIFIER	REMARKS
DIESEL ELECTRIC, GENERAL Symbol Set Code: 35 Code: 02	SHIP PROPULSION		Used with SUBMARINE entity type only.
DIESEL - TYPE 1 Symbol Set Code: 35 Code: 03	SHIP PROPULSION		Used with SUBMARINE entity type only.
DIESEL - TYPE 2 Symbol Set Code: 35 Code: 04	SHIP PROPULSION		Used with SUBMARINE entity type only.
DIESEL - TYPE 3 Symbol Set Code: 35 Code: 05	SHIP PROPULSION		Used with SUBMARINE entity type only.
NUCLEAR POWERED, GENERAL Symbol Set Code: 35 Code: 06	SHIP PROPULSION		Used with SUBMARINE entity type only.
NUCLEAR - TYPE 1 Symbol Set Code: 35 Code: 07	SHIP PROPULSION		Used with SUBMARINE entity type only.
NUCLEAR - TYPE 2 Symbol Set Code: 35 Code: 08	SHIP PROPULSION		Used with SUBMARINE entity type only.
NUCLEAR - TYPE 3 Symbol Set Code: 35 Code: 09	SHIP PROPULSION		Used with SUBMARINE entity type only.

TABLE F-V. Subsurface unit, equipment and installation sector 2 modifiers - Continued.

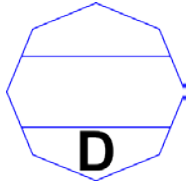
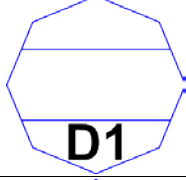
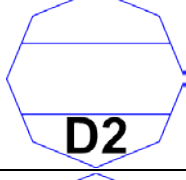
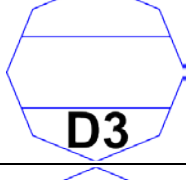
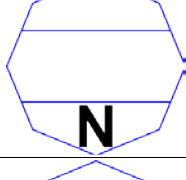
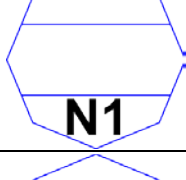
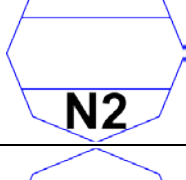

DESCRIPTION	CATEGORY	MODIFIER	REMARKS
NUCLEAR - TYPE 4 Symbol Set Code: 35 Code: 10	SHIP PROPULSION		Used with SUBMARINE entity type only.
NUCLEAR - TYPE 5 Symbol Set Code: 35 Code: 11	SHIP PROPULSION		Used with SUBMARINE entity type only.
NUCLEAR - TYPE 6 Symbol Set Code: 35 Code: 12	SHIP PROPULSION		Used with SUBMARINE entity type only.
NUCLEAR - TYPE 7 Symbol Set Code: 35 Code: 13	SHIP PROPULSION		Used with SUBMARINE entity type only.
AUTONOMOUS CONTROL Symbol Set Code: 35 Code: 14	UUV CONTROL		Used with AUV/UUV entity type only.
REMOTELY PILOTED Symbol Set Code: 35 Code: 15	UUV CONTROL		Used with AUV/UUV entity type only.
EXPENDABLE Symbol Set Code: 35 Code: 16	UUV CONTROL		Used with AUV/UUV entity type only.

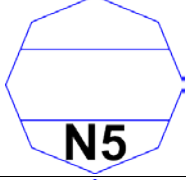
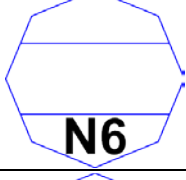
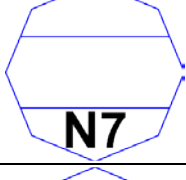
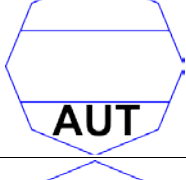
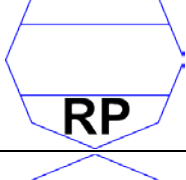
F.6.5 Subsurface local tracks. Local tracks are tracks internal to a particular Combat Information Center (CIC). These tracks are not intended to be transmitted outside the ship's CIC. [Table F-VI](#) depicts local tracks. Modifiers are not permitted with local track symbols.

F.6.5.1 Fused tracks. Fused tracks are tracks in the process of classification. Multiple sources of incoming information need to be adjudicated and combined (fused) into a single track.

Fused tracks are denoted by a question mark (?) encapsulated within an hourglass icon (see table F-VI). All fused tracks have a pending standard identity frame.

TABLE F-VI. Subsurface local tracks.

DESCRIPTION	ICON	REMARKS
ECHO TRACKER CLASSIFIER (ETC)/POSSIBLE CONTACT (POSCON) Type: Entity (Local) Symbol Set Code: 35 Code: 140000 Icon Type: Full Octagon		All ETC/POSCON tracks shall have a pending standard identity frame.
FUSED TRACK Type: Entity (Local) Symbol Set Code: 35 Code: 150000 Icon Type: Full Octagon		All fused tracks shall have a pending standard identity frame.
MANUAL TRACK Type: Entity (Local) Symbol Set Code: 35 Code: 160000 Icon Type: Full Octagon		N/A

F.7 MINE WARFARE SYMBOLS

F.7.1 Mine warfare symbols. This section includes the lists of icons for building mine warfare (MIW) symbols. There are no modifiers in MIW symbols.

F.7.2 Mine warfare icons. MIW symbols are represented using Mine Warfare Environmental Decision Aids Library (MEDAL) icons embedded within MIL-STD-2525 standard identity frames. The color in MEDAL icons represents the threat level of that contact. Red denotes mine, orange denotes mine-like contact (MILCO), yellow denotes mine-like echo (MILEC), dark green denotes non-mine mine-like object (or non-mine) and bright green denotes neutralized mine. An alternative icon set directly corresponding to MEDAL icons may also be used. The alternative set depicts the same MEDAL icons, but depicts them as black icons eliminating the color threat coding scheme. The MEDAL icons shall be used with unfilled subsurface frames. The alternative icons shall be used with the normal subsurface frames (see tables F-I, F-II and F-III). Figure F-4 shows examples of framed MEDAL and alternative icons. Table F-VII depicts mine warfare icons.

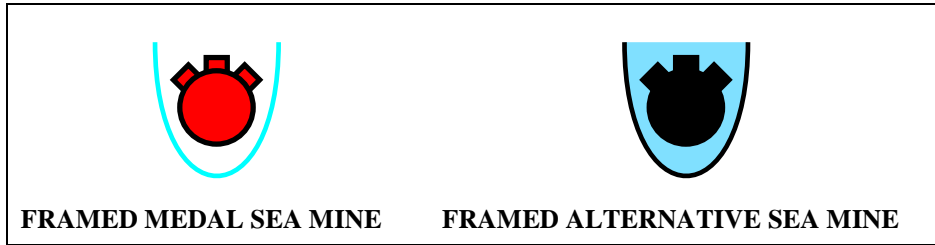

FIGURE F-4. Framing examples of MEDAL and alternative mine warfare icons.

TABLE F-VII. Mine warfare icons.

DESCRIPTION	MEDAL ICON	ALTERNATIVE ICON	REMARKS
SEA MINE, GENERAL Type: Entity Symbol Set Code: 36 Code: 110000 Icon Type: Full Octagon			N/A
SEA MINE, BOTTOM Type: Entity Type Entity: SEA MINE, GENERAL Symbol Set Code: 36 Code: 110100 Icon Type: Full Octagon			N/A
SEA MINE, MOORED Type: Entity Type Entity: SEA MINE, GENERAL Symbol Set Code: 36 Code: 110200 Icon Type: Full Octagon			N/A
SEA MINE, FLOATING Type: Entity Type Entity: SEA MINE, GENERAL Symbol Set Code: 36 Code: 110300 Icon Type: Full Octagon			N/A
SEA MINE, RISING Type: Entity Type Entity: SEA MINE, GENERAL Symbol Set Code: 36 Code: 110400 Icon Type: Full Octagon			N/A

TABLE F-VII. Mine warfare icons - Continued.







DESCRIPTION	MEDAL ICON	ALTERNATIVE ICON	REMARKS
<p>SEA MINE, OTHER POSITION</p> <p>Type: Entity Type Entity: SEA MINE, GENERAL Symbol Set Code: 36 Code: 110500 Icon Type: Full Octagon</p>			<p>N/A</p>
<p>KINGFISHER</p> <p>Type: Entity Type Entity: SEA MINE, GENERAL Symbol Set Code: 36 Code: 110600 Icon Type: Full Octagon</p>	<p>N/A</p>		<p>There is no MEDAL icon associated with this symbol.</p>
<p>SMALL OBJECT, MINE-LIKE</p> <p>Type: Entity Type Entity: SEA MINE, GENERAL Symbol Set Code: 36 Code: 110700 Icon Type: Full Octagon</p>	<p>N/A</p>		<p>There is no MEDAL icon associated with this symbol.</p>
<p>EXERCISE MINE, GENERAL</p> <p>Type: Entity Type Entity: SEA MINE, GENERAL Symbol Set Code: 36 Code: 110800 Icon Type: Full Octagon</p>			<p>Used with exercise frame only.</p>
<p>EXERCISE MINE, BOTTOM</p> <p>Type: Entity Subtype Entity/Entity Type: SEA MINE, GENERAL/EXERCISE MINE, GENERAL Symbol Set Code: 36 Code: 110801 Icon Type: Full Octagon</p>			<p>Used with exercise frame only.</p>

TABLE F-VII. Mine warfare icons - Continued.

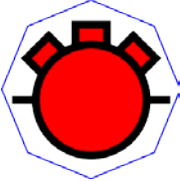
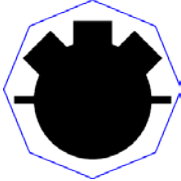







DESCRIPTION	MEDAL ICON	ALTERNATIVE ICON	REMARKS
<p>EXERCISE MINE, MOORED</p> <p>Type: Entity Subtype Entity/Entity Type: SEA MINE, GENERAL/EXERCISE MINE, GENERAL Symbol Set Code: 36 Code: 110802 Icon Type: Full Octagon</p>			<p>Used with exercise frame only.</p>
<p>EXERCISE MINE, FLOATING</p> <p>Type: Entity Subtype Entity/Entity Type: SEA MINE, GENERAL/EXERCISE MINE, GENERAL Symbol Set Code: 36 Code: 110803 Icon Type: Full Octagon</p>			<p>Used with exercise frame only.</p>
<p>EXERCISE MINE, RISING</p> <p>Type: Entity Subtype Entity/Entity Type: SEA MINE, GENERAL/EXERCISE MINE, GENERAL Symbol Set Code: 36 Code: 110804 Icon Type: Full Octagon</p>			<p>Used with exercise frame only.</p>
<p>NEUTRALIZED MINE, GENERAL</p> <p>Type: Entity Type Entity: SEA MINE, GENERAL Symbol Set Code: 36 Code: 110900 Icon Type: Full Octagon</p>			<p>N/A</p>

TABLE F-VII. Mine warfare icons - Continued.









DESCRIPTION	MEDAL ICON	ALTERNATIVE ICON	REMARKS
<p>NEUTRALIZED MINE, BOTTOM</p> <p>Type: Entity Subtype Entity/Entity Type: SEA MINE, GENERAL/NEUTRALIZED MINE, GENERAL Symbol Set Code: 36 Code: 110901 Icon Type: Full Octagon</p>			<p>N/A</p>
<p>NEUTRALIZED MINE, MOORED</p> <p>Type: Entity Subtype Entity/Entity Type: SEA MINE, GENERAL/NEUTRALIZED MINE, GENERAL Symbol Set Code: 36 Code: 110902</p>			<p>N/A</p>
<p>NEUTRALIZED MINE, FLOATING</p> <p>Type: Entity Subtype Entity/Entity Type: SEA MINE, GENERAL/NEUTRALIZED MINE, GENERAL Symbol Set Code: 36 Code: 110903 Icon Type: Full Octagon</p>			<p>N/A</p>
<p>NEUTRALIZED MINE, RISING</p> <p>Type: Entity Subtype Entity/Entity Type: SEA MINE, GENERAL/NEUTRALIZED MINE, GENERAL Symbol Set Code: 36 Code: 110904 Icon Type: Full Octagon</p>			<p>N/A</p>

TABLE F-VII. Mine warfare icons - Continued.





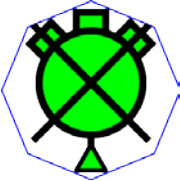



DESCRIPTION	MEDAL ICON	ALTERNATIVE ICON	REMARKS
<p>NEUTRALIZED MINE, OTHER POSITION</p> <p>Type: Entity Subtype Entity/Entity Type: SEA MINE, GENERAL/NEUTRALIZED MINE, GENERAL Symbol Set Code: 36 Code: 110905 Icon Type: Full Octagon</p>			N/A
<p>UNEXPLODED ORDNANCE</p> <p>Type: Entity Symbol Set Code: 36 Code: 120000 Icon Type: Full Octagon</p>			N/A
<p>SEA MINE DECOY</p> <p>Type: Entity Symbol Set Code: 36 Code: 130000 Icon Type: Full Octagon</p>			N/A
<p>SEA MINE DECOY, BOTTOM</p> <p>Type: Entity Type Entity: SEA MINE DECOY Symbol Set Code: 36 Code: 130100 Icon Type: Full Octagon</p>			N/A
<p>SEA MINE DECOY, MOORED</p> <p>Icon Type: Full Octagon</p> <p>Type: Entity Type Entity: SEA MINE DECOY Symbol Set Code: 36 Code: 130200 Icon Type: Full Octagon</p>			N/A
<p>MINE-LIKE CONTACT (MILCO)</p> <p>Type: Entity Symbol Set Code: 36 Code: 140000</p>	N/A	N/A	N/A

TABLE F-VII. Mine warfare icons - Continued.





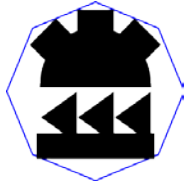

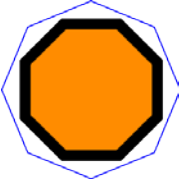
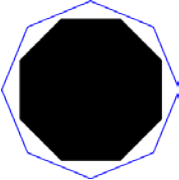

DESCRIPTION	MEDAL ICON	ALTERNATIVE ICON	REMARKS
<p>MILCO - GENERAL</p> <p>Type: Entity Type Entity: MILCO Symbol Set Code: 36 Code: 140100 Icon Type: Full Octagon</p>			<p>N/A</p>
<p>MILCO - GENERAL, CONFIDENCE LEVEL 1</p> <p>Type: Entity Subtype Entity/Entity Type: Type:MILCO/MILCO- GENERAL Symbol Set Code: 36 Code: 140101 Icon Type: Full Octagon</p>			<p>N/A</p>
<p>MILCO - GENERAL, CONFIDENCE LEVEL 2</p> <p>Type: Entity Subtype Entity/Entity Type: MILCO/MILCO-GENERAL Symbol Set Code: 36 Code: 140102 Icon Type: Full Octagon</p>			<p>N/A</p>
<p>MILCO - GENERAL, CONFIDENCE LEVEL 3</p> <p>Type: Entity Subtype Entity/Entity Type: MILCO/MILCO-GENERAL Symbol Set Code: 36 Code: 140103 Icon Type: Full Octagon</p>			<p>N/A</p>
<p>MILCO - GENERAL, CONFIDENCE LEVEL 4</p> <p>Type: Entity Subtype Entity/Entity Type: MILCO/MILCO-GENERAL Symbol Set Code: 36 Code: 140104 Icon Type: Full Octagon</p>			<p>N/A</p>

TABLE F-VII. Mine warfare icons - Continued.

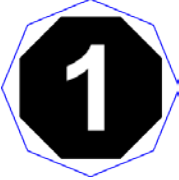







DESCRIPTION	MEDAL ICON	ALTERNATIVE ICON	REMARKS
<p>MILCO - GENERAL, CONFIDENCE LEVEL 5</p> <p>Type: Entity Subtype Entity/Entity Type: MILCO/MILCO-GENERAL Symbol Set Code: 36 Code: 140105 Icon Type: Full Octagon</p>			N/A
<p>MILCO - BOTTOM</p> <p>Type: Entity Type Entity: MILCO Symbol Set Code: 36 Code: 140200 Icon Type: Full Octagon</p>			N/A
<p>MILCO - BOTTOM, CONFIDENCE LEVEL 1</p> <p>Type: Entity Subtype Entity/Entity Type: MILCO/MILCO-BOTTOM Symbol Set Code: 36 Code: 140201 Icon Type: Full Octagon</p>			N/A
<p>MILCO - BOTTOM, CONFIDENCE LEVEL 2</p> <p>Type: Entity Subtype Entity/Entity Type: MILCO/MILCO-BOTTOM Symbol Set Code: 36 Code: 140202 Icon Type: Full Octagon</p>			N/A
<p>MILCO - BOTTOM, CONFIDENCE LEVEL 3</p> <p>Type: Entity Subtype Entity/Entity Type: MILCO/MILCO-BOTTOM Symbol Set Code: 36 Code: 140203 Icon Type: Full Octagon</p>			N/A

TABLE F-VII. Mine warfare icons - Continued.

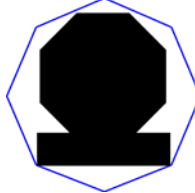





DESCRIPTION	MEDAL ICON	ALTERNATIVE ICON	REMARKS
<p>MILCO - BOTTOM, CONFIDENCE LEVEL 4</p> <p>Type: Entity Subtype Entity/Entity Type: MILCO/MILCO-BOTTOM Symbol Set Code: 36 Code: 140204 Icon Type: Full Octagon</p>			<p>N/A</p>
<p>MILCO - BOTTOM, CONFIDENCE LEVEL 5</p> <p>Type: Entity Subtype Entity/Entity Type: MILCO/MILCO-BOTTOM Symbol Set Code: 36 Code: 140205 Icon Type: Full Octagon</p>			<p>N/A</p>
<p>MILCO - MOORED</p> <p>Type: Entity Type Entity: MILCO Symbol Set Code: 36 Code: 140300 Icon Type: Full Octagon</p>			<p>N/A</p>
<p>MILCO - MOORED, CONFIDENCE LEVEL 1</p> <p>Type: Entity Subtype Entity/Entity Type: MILCO/MILCO-MOORED Symbol Set Code: 36 Code: 140301 Icon Type: Full Octagon</p>			<p>N/A</p>
<p>MILCO - MOORED, CONFIDENCE LEVEL 2</p> <p>Type: Entity Subtype Entity/Entity Type: MILCO/MILCO-MOORED Symbol Set Code: 36 Code: 140302 Icon Type: Full Octagon</p>			<p>N/A</p>

TABLE F-VII. Mine warfare icons - Continued.





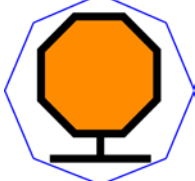
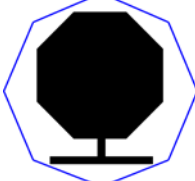
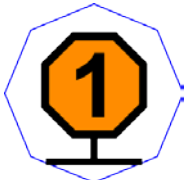
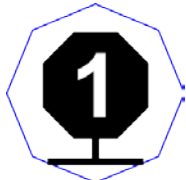



DESCRIPTION	MEDAL ICON	ALTERNATIVE ICON	REMARKS
<p>MILCO - MOORED, CONFIDENCE LEVEL 3</p> <p>Type: Entity Subtype Entity/Entity Type: MILCO/MILCO-MOORED Symbol Set Code: 36 Code: 140303 Icon Type: Full Octagon</p>			<p>N/A</p>
<p>MILCO - MOORED, CONFIDENCE LEVEL 4</p> <p>Type: Entity Subtype Entity/Entity Type: MILCO/MILCO-MOORED Symbol Set Code: 36 Code: 140304 Icon Type: Full Octagon</p>			<p>N/A</p>
<p>MILCO - MOORED, CONFIDENCE LEVEL 5</p> <p>Type: Entity Subtype Entity/Entity Type: MILCO/MILCO-MOORED Symbol Set Code: 36 Code: 140305 Icon Type: Full Octagon</p>			<p>N/A</p>
<p>MILCO - FLOATING</p> <p>Type: Entity Type Entity: MILCO Symbol Set Code: 36 Code: 140400 Icon Type: Full Octagon</p>			<p>N/A</p>
<p>MILCO - FLOATING, CONFIDENCE LEVEL 1</p> <p>Type: Entity Subtype Entity/Entity Type: MILCO/MILCO- FLOATING Symbol Set Code: 36 Code: 140401 Icon Type: Full Octagon</p>			<p>N/A</p>

TABLE F-VII. Mine warfare icons - Continued.





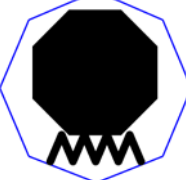



DESCRIPTION	MEDAL ICON	ALTERNATIVE ICON	REMARKS
<p>MILCO - FLOATING, CONFIDENCE LEVEL 2</p> <p>Type: Entity Subtype Entity/Entity Type: MILCO/MILCO- FLOATING Symbol Set Code: 36 Code: 140402 Icon Type: Full Octagon</p>			<p>N/A</p>
<p>MILCO - FLOATING, CONFIDENCE LEVEL 3</p> <p>Type: Entity Subtype Entity/Entity Type: MILCO/MILCO- FLOATING Symbol Set Code: 36 Code: 140403 Icon Type: Full Octagon</p>			<p>N/A</p>
<p>MILCO - FLOATING, CONFIDENCE LEVEL 4</p> <p>Type: Entity Subtype Entity/Entity Type: MILCO/MILCO- FLOATING Symbol Set Code: 36 Code: 140404 Icon Type: Full Octagon</p>			<p>N/A</p>
<p>MILCO - FLOATING, CONFIDENCE LEVEL 5</p> <p>Type: Entity Subtype Entity/Entity Type: MILCO/MILCO- FLOATING Symbol Set Code: 36 Code: 140405 Icon Type: Full Octagon</p>			<p>N/A</p>
<p>MINE-LIKE ECHO (MILEC), GENERAL</p> <p>Type: Entity Symbol Set Code: 36 Code: 150000 Icon Type: Full Octagon</p>			<p>N/A</p>

TABLE F-VII. Mine warfare icons - Continued.







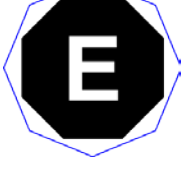

DESCRIPTION	MEDAL ICON	ALTERNATIVE ICON	REMARKS
<p>MINE-LIKE ECHO, BOTTOM</p> <p>Type: Entity Type Entity: MINE-LIKE ECHO (MILEC), GENERAL Symbol Set Code: 36 Code: 150100 Icon Type: Full Octagon</p>			N/A
<p>MINE-LIKE ECHO, MOORED</p> <p>Type: Entity Type Entity: MINE-LIKE ECHO (MILEC), GENERAL Symbol Set Code: 36 Code: 150200 Icon Type: Full Octagon</p>			N/A
<p>MINE-LIKE ECHO, FLOATING</p> <p>Type: Entity Type Entity: MINE-LIKE ECHO (MILEC), GENERAL Symbol Set Code: 36 Code: 150300 Icon Type: Full Octagon</p>			N/A
<p>NEGATIVE REACQUISITION, GENERAL</p> <p>Type: Entity Symbol Set Code: 36 Code: 160000 Icon Type: Full Octagon</p>			N/A
<p>NEGATIVE REACQUISITION, BOTTOM</p> <p>Type: Entity Type Entity: NEGATIVE REACQUISITION, GENERAL Symbol Set Code: 36 Code: 160100 Icon Type: Full Octagon</p>			N/A

TABLE F-VII. Mine warfare icons - Continued.

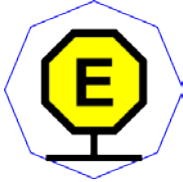
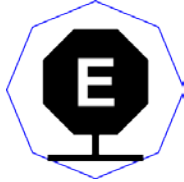













DESCRIPTION	MEDAL ICON	ALTERNATIVE ICON	REMARKS
<p>NEGATIVE REACQUISITION, MOORED</p> <p>Type: Entity Type Entity: NEGATIVE REACQUISITION, GENERAL Symbol Set Code: 36 Code: 160200 Icon Type: Full Octagon</p>			N/A
<p>NEGATIVE REACQUISITION, FLOATING</p> <p>Type: Entity Type Entity: NEGATIVE REACQUISITION, GENERAL Symbol Set Code: 36 Code: 160300 Icon Type: Full Octagon</p>			N/A
<p>OBSTRUCTOR</p> <p>Type: Entity Symbol Set Code: 36 Code: 170000 Icon Type: Full Octagon</p>			N/A
<p>NEUTRALIZED OBSTRUCTOR</p> <p>Type: Entity Type Entity: OBSTRUCTOR Symbol Set Code: 36 Code: 170100 Icon Type: Full Octagon</p>			N/A
<p>GENERAL MINE ANCHOR</p> <p>Type: Entity Symbol Set Code: 36 Code: 180000 Icon Type: Full Octagon</p>			N/A
<p>NON-MINE MINE-LIKE OBJECT (NMLO), GENERAL</p> <p>Type: Entity Symbol Set Code: 36 Code: 190000 Icon Type: Full Octagon</p>			N/A

TABLE F-VII. Mine warfare icons - Continued.

DESCRIPTION	MEDAL ICON	ALTERNATIVE ICON	REMARKS
<p>NON-MINE MINE-LIKE OBJECT, BOTTOM</p> <p>Type: Entity Type Entity: NON-MINE MINE-LIKE OBJECT (NMLLO), GENERAL Symbol Set Code: 36 Code: 190100 Icon Type: Full Octagon</p>			<p>N/A</p>
<p>NON-MINE MINE-LIKE OBJECT, MOORED</p> <p>Type: Entity Type Entity: NON-MINE MINE-LIKE OBJECT (NMLLO), GENERAL Symbol Set Code: 36 Code: 190200 Icon Type: Full Octagon</p>			<p>N/A</p>
<p>NON-MINE MINE-LIKE OBJECT, FLOATING</p> <p>Type: Entity Type Entity: NON-MINE MINE-LIKE OBJECT (NMLLO), GENERAL Symbol Set Code: 36 Code: 190300 Icon Type: Full Octagon</p>			<p>N/A</p>
<p>ENVIRONMENTAL REPORT LOCATION</p> <p>Type: Entity Symbol Set Code: 36 Code: 200000 Icon Type: Full Octagon</p>			<p>N/A</p>
<p>DIVE REPORT LOCATION</p> <p>Type: Entity Symbol Set Code: 36 Code: 210000 Icon Type: Full Octagon</p>			<p>N/A</p>

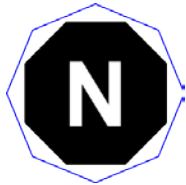
APPENDIX G - ACTIVITIES SYMBOLS

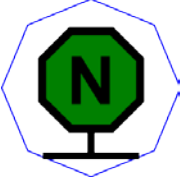
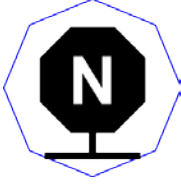
G.1 SCOPE

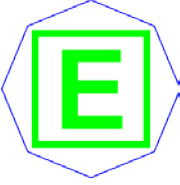
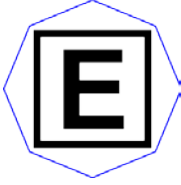
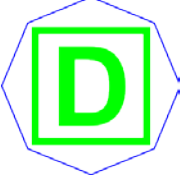
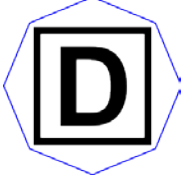
G.1.1 Scope. In this appendix, activities across the range of military operations use various symbols to predominately show support. Activities include stability operations, defense support to civil authorities, foreign humanitarian assistance, incidents, natural events, and operations. Among the types of activities represented are acts of terrorism, sabotage, crime, natural disasters, relief operations, and the uncontrolled movement of large numbers of people. The tables in this appendix present the icons and modifiers used for support stability operations, defense support to civil authorities, and foreign humanitarian assistance. Many of these icons represent emergency first response events used in a civilian community. This appendix is a mandatory part of the standard. The information contained herein is intended for compliance.

G.2 APPLICABLE DOCUMENTS

Specific documents in [2.2](#) of this standard apply to this appendix.

G.3 DEFINITIONS

The definitions in [section 3](#) of this standard apply to this appendix.

G.4 GENERAL REQUIREMENTS

G.4.1 Organization. This appendix contains technical specifications, a symbol coding scheme, a symbology hierarchy and supports activities symbology.

G.5 DETAILED REQUIREMENTS

G.5.1 Technical specifications. Composition, construction and display of symbols are explained in the detailed requirements section of the standard.

G.5.2 Symbol identification coding scheme. A symbol identification code (SIDC) is a numeric string that may be used to provide the unique identifier necessary to display or exchange symbol information between MIL-STD-2525 compliant systems. Refer to [Appendix A](#) for SIDC positions and descriptions.

G.5.3 Composition of activities symbols. A standard method for constructing symbols is presented. Refer to [5.3.8](#) for an explanation of symbol composition. [Figure G-1](#) shows an example of a activities symbol.

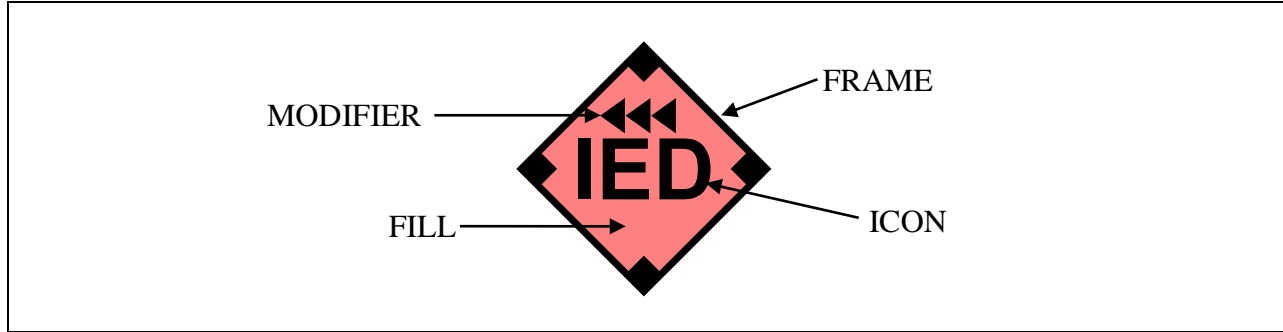



FIGURE G-1. Activities components.

G.5.3.1 Symbol building process. [Table G-I](#) depicts the symbol building process for activities symbols. The process is identical for icons and modifiers requiring the vertical bounding octagon. Activities symbols use the land frames for units, equipment and installations, as well as the activity/event frames for incidents.

TABLE G-I. Activities symbol building process.

STEP	DESCRIPTION	EXAMPLE
1.	Choose the frame that matches the standard identity of the object from the activity/event column in tables I, II, or III. In this example, the standard identity is hostile. The example depicts a “hostile incident.”	
2.	Choose an icon for the symbol. In this example, the icon is “IED,” an equipment entity subtype. The example depicts a “hostile IED incident.”	
3.	If required, choose a modifier to depict an additional characteristic of the icon. In this example, the modifier is “hoax,” a sector 1 modifier. The example depicts “hostile IED hoax incident.” Note: There are no sector 2 modifiers in activities symbols.	

TABLE G-I. Activities symbol building process - Continued.

STEP	DESCRIPTION	EXAMPLE
4.	The finished symbol will appear as shown in the example.	

G.5.3.2 Icons and modifiers. All icons shall be placed within the main sector of the bounding octagon (see table G-I). When depicted, modifiers shall be placed in sectors 1 or 2 as appropriate (see table G-I). Only one modifier may be placed in each sector at a given time. Multiple modifiers in the same position are prohibited due to legibility concerns.

G.5.3.3 Amplifiers.

G.5.3.3.1 Text amplifiers. The purpose of the static text amplifiers described in this appendix is to standardize the display of additional alphanumeric information on identity, movement and location and capabilities. See 5.1.6 for more information on amplifiers. Figure G-2 shows the placement of activities symbol amplifiers around the friend symbol frame. Table G-II provides descriptions and formats of each amplifier.

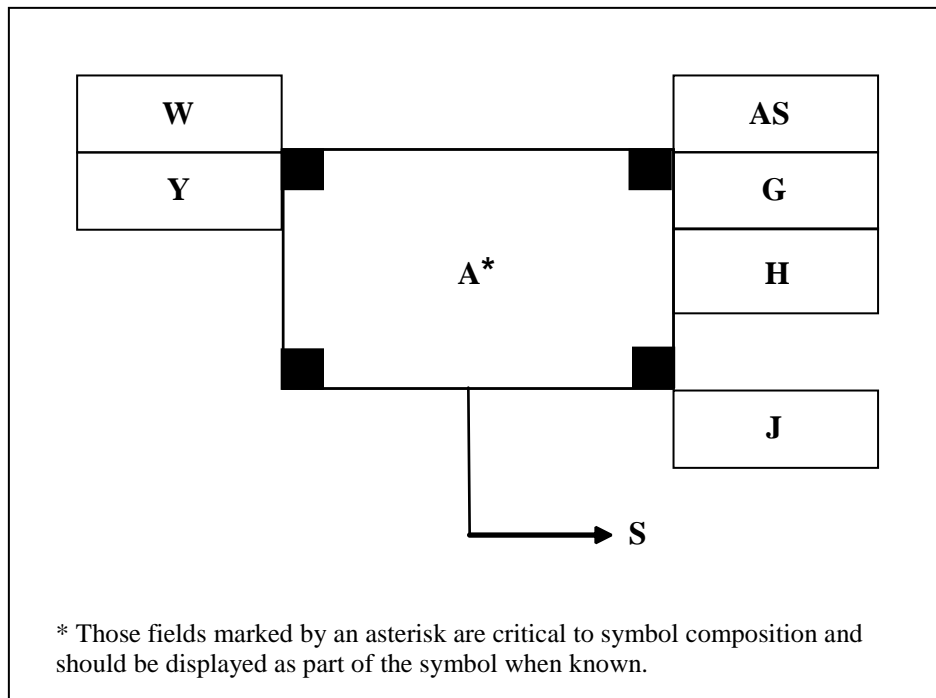

FIGURE G-2. Activities icon, modifier and amplifier fields.

MIL-STD-2525D - APPENDIX G

TABLE G-II. Description of icon, modifier and amplifier fields for activities symbols.

Field	Field Title	Description	Text/Graphic
A	Symbol	Symbol contains an icon in the “Main” sector of the bounding octagon and may contain a modifier in sector 1, sector 2, or both.	Either
G	Staff Comments	Free text. Can be used by staff for information required by commander.	Text
H	Additional Information	Free text.	Text
J	Evaluation Rating	<p>Degree of confidence that may be placed on the information represented by the symbol. It is shown as one letter and one number made up of Reliability of Source and Credibility of Information. (STANAG 2511).</p> <p>Reliability of Source: A. Completely reliable B. Usually reliable C. Fairly reliable D. Not usually reliable E. Unreliable F. Reliability cannot be judged.</p> <p>Credibility of Information: 1. Confirmed by other sources 2. Probably true 3. Possibly true 4. Doubtful 5. Improbable 6. Truth cannot be judged.</p>	Text
S	Offset Location Indicator	It is used to denote precise location.	Graphic
W	Date-Time Group	An alphanumeric designator for displaying a date-time group (DDHHMMSSZMONYY) or “O/O” for on order. The date-time group is composed of a group of six numeric digits with a time zone suffix and the standardized three-letter abbreviation for the month followed by two digits. The first pair of digits represents the day; the second pair, the hour; the third pair, the minutes. The last two digits of the year are after the month. For automated systems, two digits may be added before the time zone suffix and after the minutes to designate seconds.	Text
Y	Location	A text amplifier for units, equipment and installations that displays a symbol’s location in degrees, minutes and decimal minutes (or in MGRS or other applicable display format).	Text
AS	Country Indicator	A three-letter code that indicates the country of origin of the organization (STANAG 1059). In stability activities, this field can be used for factions or groups.	Text

G.5.3.3.2 Graphic amplifiers. Graphic amplifiers can be static, located in a fixed position in relation to a track's symbol, or dynamic and move about the symbol based on the track's characteristics. [See 5.1.6](#) for more information on amplifiers, including examples of dynamic amplifiers.

G.6 ACTIVITIES SYMBOLS

G.6.1 Activities symbols. This section includes the lists of icons and modifiers for building activities symbols.

G.6.2 Activities icons. [Table G-III](#) depicts activities icons.

TABLE G-III. Activities icons.



DESCRIPTION	ICON	REMARKS
<p>INCIDENT</p> <p>Type: Entity Symbol Set Code: 40 Code: 110000</p>	N/A	No icon is associated with this entity. It is for hierarchal purposes only.
<p>CRIMINAL ACTIVITY INCIDENT</p> <p>Type: Entity Type Entity: INCIDENT Symbol Set Code: 40 Code: 110100 Icon Type: Full Octagon</p>		N/A
<p>ARREST</p> <p>Type: Entity Subtype Entity: INCIDENT/ CRIMINAL ACTIVITY INCIDENT Symbol Set Code: 40 Code: 110101 Icon Type: Full Octagon</p>		N/A
<p>ARSON</p> <p>Type: Entity Subtype Entity/Entity Type: INCIDENT/ CRIMINAL ACTIVITY INCIDENT Symbol Set Code: 40 Code: 110102 Icon Type: Full Octagon</p>		N/A
<p>ATTEMPTED CRIMINAL ACTIVITY</p> <p>Type: Entity Subtype Entity/Entity Type: INCIDENT/ CRIMINAL ACTIVITY INCIDENT Symbol Set Code: 40 Code: 110103 Icon Type: Main</p>		APP-6C

TABLE G-III. Activities icons - Continued.



DESCRIPTION	ICON	REMARKS
<p>DRIVE-BY SHOOTING</p> <p>Type: Entity Subtype Entity/Entity Type: INCIDENT/ CRIMINAL ACTIVITY INCIDENT Symbol Set Code: 40 Code: 110104 Icon Type: Full Octagon</p>		<p>N/A</p>
<p>DRUG RELATED</p> <p>Type: Entity Subtype Entity/Entity Type: INCIDENT/ CRIMINAL ACTIVITY INCIDENT Symbol Set Code: 40 Code: 110105 Icon Type: Main</p>		<p>APP-6C</p>
<p>EXTORTION</p> <p>Type: Entity Subtype Entity/Entity Type: INCIDENT/ CRIMINAL ACTIVITY INCIDENT Symbol Set Code: 40 Code: 110106 Icon Type: Full Octagon</p>		<p>N/A</p>
<p>GRAFFITI</p> <p>Type: Entity Subtype Entity/Entity Type: INCIDENT/ CRIMINAL ACTIVITY INCIDENT Symbol Set Code: 40 Code: 110107 Icon Type: Full Octagon</p>		<p>N/A</p>
<p>KILLING</p> <p>Type: Entity Subtype Entity/Entity Type: INCIDENT/ CRIMINAL ACTIVITY INCIDENT Symbol Set Code: 40 Code: 110108 Icon Type: Main</p>		<p>N/A</p>
<p>POISONING</p> <p>Type: Entity Subtype Entity/Entity Type: INCIDENT/ CRIMINAL ACTIVITY INCIDENT Symbol Set Code: 40 Code: 110109 Icon Type: Full Octagon</p>		<p>N/A</p>

TABLE G-III. Activities icons - Continued.

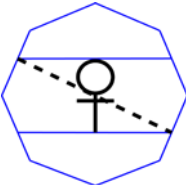

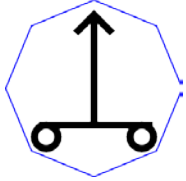

DESCRIPTION	ICON	REMARKS
<p>CIVIL RIOTING</p> <p>Type: Entity Subtype Entity/Entity Type: INCIDENT/ CRIMINAL ACTIVITY INCIDENT Symbol Set Code: 40 Code: 110110 Icon Type: Main</p>		<p>N/A</p>
<p>BOOBY TRAP</p> <p>Type: Entity Subtype Entity/Entity Type: INCIDENT/ CRIMINAL ACTIVITY INCIDENT Symbol Set Code: 40 Code: 110111 Icon Type: Full Octagon</p>		<p>N/A</p>
<p>HOME EVICTION</p> <p>Type: Entity Subtype Entity/Entity Type: INCIDENT/ CRIMINAL ACTIVITY INCIDENT Symbol Set Code: 40 Code: 110112 Icon Type: Full Octagon</p>		<p>N/A</p>
<p>BLACK MARKETING</p> <p>Type: Entity Subtype Entity/Entity Type: INCIDENT/ CRIMINAL ACTIVITY INCIDENT Symbol Set Code: 40 Code: 110113 Icon Type: Full Octagon</p>		<p>N/A</p>
<p>VANDALISM / LOOT / RANSACK / PLUNDER</p> <p>Type: Entity Subtype Entity/Entity Type: INCIDENT/ CRIMINAL ACTIVITY INCIDENT Symbol Set Code: 40 Code: 110114 Icon Type: Full Octagon</p>		<p>N/A</p>
<p>JAIL BREAK</p> <p>Type: Entity Subtype Entity/Entity Type: INCIDENT/ CRIMINAL ACTIVITY INCIDENT Symbol Set Code: 40 Code: 110115 Icon Type: Full Octagon</p>		<p>N/A</p>

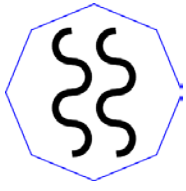
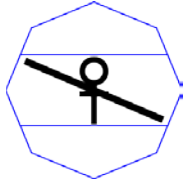
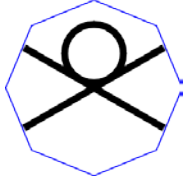
TABLE G-III. Activities icons - Continued.



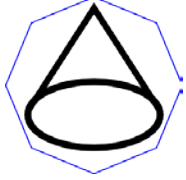
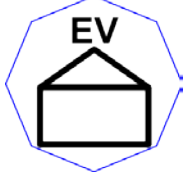

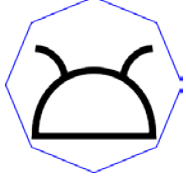
DESCRIPTION	ICON	REMARKS
ROBBERY Type: Entity Subtype Entity/Entity Type: INCIDENT/ CRIMINAL ACTIVITY INCIDENT Symbol Set Code: 40 Code: 110116 Icon Type: Main		N/A
THEFT Type: Entity Subtype Entity/Entity Type: INCIDENT/ CRIMINAL ACTIVITY INCIDENT Symbol Set Code: 40 Code: 110117 Icon Type: Main		N/A
BURGLARY Type: Entity Subtype Entity/Entity Type: INCIDENT/ CRIMINAL ACTIVITY INCIDENT Symbol Set Code: 40 Code: 110118 Icon Type: Main		N/A
SMUGGLING Type: Entity Subtype Entity/Entity Type: INCIDENT/ CRIMINAL ACTIVITY INCIDENT Symbol Set Code: 40 Code: 110119 Icon Type: Main		N/A
ROCK THROWING Type: Entity Subtype Entity/Entity Type: INCIDENT/ CRIMINAL ACTIVITY INCIDENT Symbol Set Code: 40 Code: 110120 Icon Type: Full Octagon		N/A
DEAD BODY Type: Entity Subtype Entity/Entity Type: INCIDENT/ CRIMINAL ACTIVITY INCIDENT Symbol Set Code: 40 Code: 110121 Icon Type: Full Octagon		N/A

TABLE G-III. Activities icons - Continued.





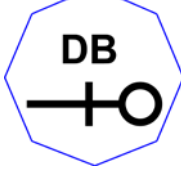

DESCRIPTION	ICON	REMARKS
SABOTAGE Type: Entity Subtype Entity/Entity Type: INCIDENT/ CRIMINAL ACTIVITY INCIDENT Code: 110122 Icon Type: Main		N/A
SUSPICIOUS ACTIVITY Type: Entity Subtype Entity/Entity Type: INCIDENT/ CRIMINAL ACTIVITY INCIDENT Symbol Set Code: 40 Code: 110123 Icon Type: Full Octagon		N/A
BOMB/BOMBING Type: Entity Type Entity: INCIDENT Symbol Set Code: 40 Code: 110200 Icon Type: Main		N/A
BOMB THREAT Type: Entity Subtype Entity/Entity Type: INCIDENT/BOMB/BOMBING Symbol Set Code: 40 Code: 110201 Icon Type: Full Octagon		N/A
IED EVENT Type: Entity Type Entity: INCIDENT Symbol Set Code: 40 Code: 110300 Icon Type: Main		N/A
IED EXPLOSION Type: Entity Subtype Entity/Entity Type: INCIDENT/IED EVENT Symbol Set Code: 40 Code: 110301 Icon Type: Full Octagon		N/A

TABLE G-III. Activities icons - Continued.





DESCRIPTION	ICON	REMARKS
<p>PREMATURE IED EXPLOSION</p> <p>Type: Entity Subtype Entity/Entity Type: INCIDENT/IED EVENT Symbol Set Code: 40 Code: 110302 Icon Type: Full Octagon</p>		<p>N/A</p>
<p>IED CACHE</p> <p>Type: Entity Subtype Entity/Entity Type: INCIDENT/IED EVENT Symbol Set Code: 40 Code: 110303 Icon Type: Full Frame</p>		<p>The grey box is not to be drawn. It is shown here only as a reference to position and proportion of the icon within the frame.</p>
<p>IED SUICIDE BOMBER</p> <p>Type: Entity Subtype Entity/Entity Type: INCIDENT/IED EVENT Symbol Set Code: 40 Code: 110304 Icon Type: Full Octagon</p>		<p>N/A</p>
<p>SHOOTING</p> <p>Type: Entity Type Entity: INCIDENT Symbol Set Code: 40 Code: 110400 Icon Type: Full Octagon</p>		<p>N/A</p>
<p>SNIPING</p> <p>Type: Entity Subtype Entity/Entity Type: INCIDENT/SHOOTING Symbol Set Code: 40 Code: 110401 Icon Type: Full Octagon</p>		<p>N/A</p>
<p>ILLEGAL DRUG OPERATION</p> <p>Type: Entity Type Entity: INCIDENT Symbol Set Code: 40 Code: 110500 Icon Type: Main</p>		<p>N/A</p>

TABLE G-III. Activities icons - Continued.



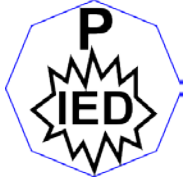
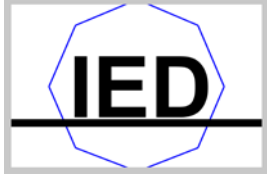

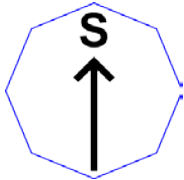

DESCRIPTION	ICON	REMARKS
TRAFFICKING Type: Entity Subtype Entity/Entity Type: INCIDENT/ILLEGAL DRUG OPERATION Symbol Set Code: 40 Code: 110501 Icon Type: Full Octagon		N/A
ILLEGAL DRUG LAB Type: Entity Subtype Entity/Entity Type: INCIDENT/ILLEGAL DRUG OPERATION Symbol Set Code: 40 Code: 110502 Icon Type: Full Octagon		N/A
EXPLOSION Type: Entity Type Entity: INCIDENT Symbol Set Code: 40 Code: 110600 Icon Type: Full Octagon		N/A
GRENADE EXPLOSION Type: Entity Subtype Entity: INCIDENT/EXPLOSION Symbol Set Code: 40 Code: 110601 Icon Type: Full Octagon		N/A
INCENDIARY EXPLOSION Type: Entity Subtype Entity: INCIDENT/EXPLOSION Symbol Set Code: 40 Code: 110602 Icon Type: Full Octagon		N/A
MINE EXPLOSION Type: Entity Subtype Entity: INCIDENT/EXPLOSION Symbol Set Code: 40 Code: 110603 Icon Type: Full Octagon		N/A

TABLE G-III. Activities icons - Continued.



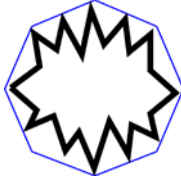

DESCRIPTION	ICON	REMARKS
<p>MORTAR FIRE EXPLOSION</p> <p>Type: Entity Subtype Entity: INCIDENT/EXPLOSION Symbol Set Code: 40 Code: 110604 Icon Type: Full Octagon</p>		<p>N/A</p>
<p>ROCKET EXPLOSION</p> <p>Type: Entity Subtype Entity: INCIDENT/EXPLOSION Symbol Set Code: 40 Code: 110605 Icon Type: Full Octagon</p>		<p>N/A</p>
<p>BOMB EXPLOSION</p> <p>Type: Entity Subtype Entity: INCIDENT/EXPLOSION Symbol Set Code: 40 Code: 110606 Icon Type: Full Octagon</p>		<p>N/A</p>
<p>CIVIL DISTURBANCE</p> <p>Type: Entity Symbol Set Code: 40 Code: 120000 Icon Type: Full Octagon</p>		
<p>DEMONSTRATION</p> <p>Type: Entity Type Entity/Entity Type: CIVIL DISTURBANCE Symbol Set Code: 40 Code: 120100 Icon Type: Main</p>		<p>N/A</p>
<p>OPERATION</p> <p>Type: Entity Symbol Set Code: 40 Code: 130000</p>	<p>N/A</p>	<p>No icon is associated with this entity. It is for hierarchal purposes only.</p>
<p>PATROLLING</p> <p>Type: Entity Type Entity: OPERATION Symbol Set Code: 40 Code: 130100 Icon Type: Full Octagon</p>		<p>N/A</p>

TABLE G-III. Activities icons - Continued.

DESCRIPTION	ICON	REMARKS
<p>MILITARY INFORMATION SUPPORT OPERATION (MISO)</p> <p>Type: Entity Type Entity: OPERATION Symbol Set Code: 40 Code: 130200 Icon Type: Full Octagon</p>		<p>N/A</p>
<p>TV AND RADIO PROPAGANDA</p> <p>Type: Entity Subtype Entity/Entity Type: OPERATION/MISO OPERATION Symbol Set Code: 40 Code: 130201 Icon Type: Full Frame</p>		<p>The grey box is not to be drawn. It is shown here only as a reference to position and proportion of the icon within the frame.</p>
<p>FORAGING/SEARCHING</p> <p>Type: Entity Type Entity: OPERATION Symbol Set Code: 40 Code: 130300 Icon Type: Full Octagon</p>		<p>N/A</p>
<p>RECRUITMENT</p> <p>Type: Entity Type Entity: OPERATION Symbol Set Code: 40 Code: 130400</p>	<p>N/A</p>	<p>No icon is associated with this entity. It is for hierarchal purposes only.</p>
<p>WILLING</p> <p>Type: Entity Subtype Entity/Entity Type: OPERATION/RECRUITMENT Symbol Set Code: 40 Code: 130401 Icon Type: Full Octagon</p>		<p>N/A</p>
<p>COERCED/IMPRESSED</p> <p>Type: Entity Subtype Entity/Entity Type: OPERATION/RECRUITMENT Symbol Set Code: 40 Code: 130402 Icon Type: Full Octagon</p>		<p>N/A</p>

TABLE G-III. Activities icons - Continued.



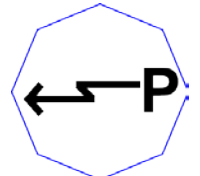

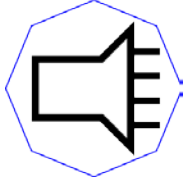
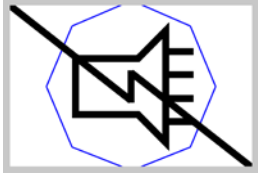
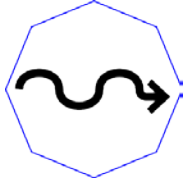
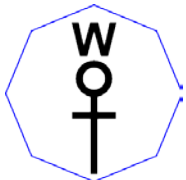
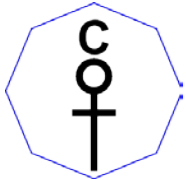

DESCRIPTION	ICON	REMARKS
MINE LAYING Type: Entity Type Entity: OPERATION Symbol Set Code: 40 Code: 130500 Icon Type: Main		N/A
SPY Type: Entity Type Entity: OPERATION Symbol Set Code: 40 Code: 130600 Icon Type: Main		N/A
WARRANT SERVED Type: Entity Type Entity: OPERATION Symbol Set Code: 40 Code: 130700 Icon Type: Main		N/A
EXFILTRATION Type: Entity Type Entity: OPERATION Symbol Set Code: 40 Code: 130800 Icon Type: Full Octagon		N/A
INFILTRATION Type: Entity Type Entity: OPERATION Symbol Set Code: 40 Code: 130900 Icon Type: Full Octagon		N/A
MEETING Type: Entity Type Entity: OPERATION Symbol Set Code: 40 Code: 131000 Icon Type: Full Octagon		N/A
POLLING PLACE/ELECTION Type: Entity Type Entity: OPERATION/MEETING Symbol Set Code: 40 Code: 131001 Icon Type: Full Octagon		N/A

TABLE G-III. Activities icons - Continued.

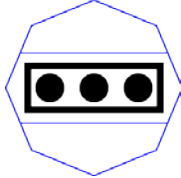



DESCRIPTION	ICON	REMARKS
<p>RAID ON HOUSE</p> <p>Type: Entity Type Entity: OPERATION Symbol Set Code: 40 Code: 131100 Icon Type: Full Octagon</p>		<p>N/A</p>
<p>EMERGENCY OPERATION</p> <p>Type: Entity Type Entity: OPERATION Symbol Set Code: 40 Code: 131200 Icon Type: Full Octagon</p>		<p>N/A</p>
<p>EMERGENCY COLLECTION EVACUATION POINT</p> <p>Type: Entity Subtype Entity/Entity Type: OPERATION/EMERGENCY OPERATION Symbol Set Code: 40 Code: 131201 Icon Type: Full Octagon</p>		<p>N/A</p>
<p>EMERGENCY FOOD DISTRIBUTION</p> <p>Type: Entity Type Entity: OPERATION Symbol Set Code: 40 Code: 131202 Icon Type: Full Frame</p>		<p>The grey box is not to be drawn. It is shown here only as a reference to position and proportion of the icon within the frame.</p>
<p>EMERGENCY INCIDENT COMMAND CENTER</p> <p>Type: Entity Subtype Entity/Entity Type: OPERATION/EMERGENCY OPERATION Symbol Set Code: 40 Code: 131203 Icon Type: Full Octagon</p>		<p>N/A</p>

TABLE G-III. Activities icons - Continued.



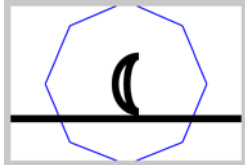

DESCRIPTION	ICON	REMARKS
<p>EMERGENCY OPERATIONS CENTER</p> <p>Type: Entity Subtype Entity/Entity Type: OPERATION/EMERGENCY OPERATION Symbol Set Code: 40 Code: 131204 Icon Type: Full Octagon</p>		<p>N/A</p>
<p>EMERGENCY PUBLIC INFORMATION CENTER</p> <p>Type: Entity Subtype Entity/Entity Type: OPERATION/EMERGENCY OPERATION Symbol Set Code: 40 Code: 131205 Icon Type: Full Octagon</p>		<p>N/A</p>
<p>EMERGENCY SHELTER</p> <p>Type: Entity Subtype Entity/Entity Type: OPERATION/EMERGENCY OPERATION Symbol Set Code: 40 Code: 131206 Icon Type: Full Octagon</p>		<p>N/A</p>
<p>EMERGENCY STAGING AREA</p> <p>Type: Entity Subtype Entity/Entity Type: OPERATION/EMERGENCY OPERATION Symbol Set Code: 40 Code: 131207 Icon Type: Full Octagon</p>		<p>N/A</p>
<p>EMERGENCY WATER DISTRIBUTION CENTER</p> <p>Type: Entity Subtype Entity/Entity Type: OPERATION/EMERGENCY OPERATION Symbol Set Code: 40 Code: 131208 Icon Type: Full Frame</p>		<p>The grey box is not to be drawn. It is shown here only as a reference to position and proportion of the icon within the frame.</p>

TABLE G-III. Activities icons - Continued.



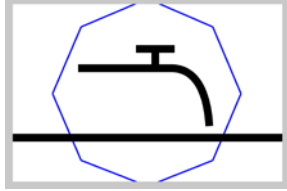

DESCRIPTION	ICON	REMARKS
<p>EMERGENCY MEDICAL OPERATIONS</p> <p>Type: Entity Type Entity: OPERATION Symbol Set Code: 40 Code: 131300 Icon Type: Full Octagon</p>		<p>N/A</p>
<p>EMT STATION LOCATION</p> <p>Type: Entity Subtype Entity/Entity Type: OPERATION/EMERGENCY MEDICAL OPERATION Symbol Set Code: 40 Code: 131301 Icon Type: Full Octagon</p>		<p>N/A</p>
<p>HEALTH DEPARTMENT FACILITY</p> <p>Type: Entity Subtype Entity/Entity Type: OPERATION/EMERGENCY MEDICAL OPERATION Symbol Set Code: 40 Code: 131302 Icon Type: Full Octagon</p>		<p>N/A</p>
<p>MEDICAL FACILITIES OUTPATIENT</p> <p>Type: Entity Subtype Entity/Entity Type: OPERATION/EMERGENCY MEDICAL OPERATION Symbol Set Code: 40 Code: 131303 Icon Type: Full Octagon</p>		<p>N/A</p>
<p>MORGUE</p> <p>Type: Entity Subtype Entity/Entity Type: OPERATION/EMERGENCY MEDICAL OPERATION Symbol Set Code: 40 Code: 131304 Icon Type: Full Octagon</p>		<p>N/A</p>

TABLE G-III. Activities icons - Continued.



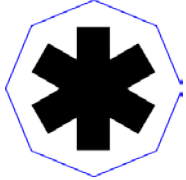



DESCRIPTION	ICON	REMARKS
<p>PHARMACY</p> <p>Type: Entity Subtype Entity/Entity Type: OPERATION/EMERGENCY MEDICAL OPERATION Symbol Set Code: 40 Code: 131305 Icon Type: Full Octagon</p>		<p>N/A</p>
<p>TRIAGE</p> <p>Type: Entity Subtype Entity/Entity Type: OPERATION/EMERGENCY MEDICAL OPERATION Symbol Set Code: 40 Code: 131306 Icon Type: Full Octagon</p>		<p>N/A</p>
<p>FIRE FIGHTING OPERATION</p> <p>Type: Entity Type Entity: OPERATION Symbol Set Code: 40 Code: 131400 Icon Type: Main</p>		<p>N/A</p>
<p>FIRE HYDRANT</p> <p>Type: Entity Type Entity: OPERATION/ FIRE FIGHTING OPERATION Symbol Set Code: 40 Code: 131401 Icon Type: Full Octagon</p>		<p>N/A</p>
<p>FIRE STATION</p> <p>Type: Entity Type Entity: OPERATION/ FIRE FIGHTING OPERATION Symbol Set Code: 40 Code: 131402 Icon Type: Full Octagon</p>		<p>N/A</p>
<p>OTHER WATER SUPPLY LOCATION</p> <p>Type: Entity Type Entity: OPERATION/ FIRE FIGHTING OPERATION Symbol Set Code: 40 Code: 131403 Icon Type: Full Octagon</p>		<p>N/A</p>

TABLE G-III. Activities icons - Continued.



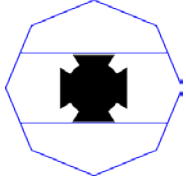

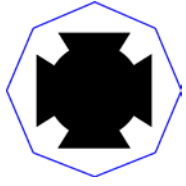
DESCRIPTION	ICON	REMARKS
<p>LAW ENFORCEMENT OPERATION</p> <p>Type: Entity Type Entity: OPERATION Symbol Set Code: 40 Code: 131500 Icon Type: Full Octagon</p>		N/A
<p>BUREAU OF ALCOHOL, TOBACCO, FIREARMS AND EXPLOSIVES (ATF) (DEPARTMENT OF JUSTICE)</p> <p>Type: Entity Subtype Entity/Entity Type: OPERATION/LAW ENFORCEMENT OPERATION Symbol Set Code: 40 Code: 131501 Icon Type: Main</p>		N/A
<p>BORDER PATROL</p> <p>Type: Entity Subtype Entity/Entity Type: OPERATION/LAW ENFORCEMENT OPERATION Symbol Set Code: 40 Code: 131502 Icon Type: Full Octagon</p>		N/A
<p>CUSTOMS SERVICE</p> <p>Type: Entity Subtype Entity/Entity Type: OPERATION/LAW ENFORCEMENT OPERATION Symbol Set Code: 40 Code: 131503 Icon Type: Full Octagon</p>		N/A
<p>DRUG ENFORCEMENT ADMINISTRATION (DEA)</p> <p>Type: Entity Subtype Entity/Entity Type: OPERATION/LAW ENFORCEMENT OPERATION Symbol Set Code: 40 Code: 131504 Icon Type: Main</p>		N/A

TABLE G-III. Activities icons - Continued.



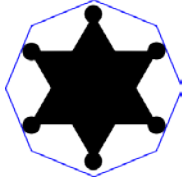

DESCRIPTION	ICON	REMARKS
<p>DEPARTMENT OF JUSTICE (DOJ)</p> <p>Type: Entity Subtype Entity/Entity Type: OPERATION/LAW ENFORCEMENT OPERATION Symbol Set Code: 40 Code: 131505 Icon Type: Full Octagon</p>		<p>N/A</p>
<p>FEDERAL BUREAU OF INVESTIGATION (FBI)</p> <p>Type: Entity Subtype Entity/Entity Type: OPERATION/LAW ENFORCEMENT OPERATION Symbol Set Code: 40 Code: 131506 Icon Type: Main</p>		<p>N/A</p>
<p>POLICE</p> <p>Type: Entity Subtype Entity/Entity Type: OPERATION/LAW ENFORCEMENT OPERATION Symbol Set Code: 40 Code: 131507 Icon Type: Main</p>		<p>N/A</p>
<p>PRISON</p> <p>Type: Entity Subtype Entity/Entity Type: OPERATION/LAW ENFORCEMENT OPERATION Symbol Set Code: 40 Code: 131508 Icon Type: Full Octagon</p>		<p>N/A</p>
<p>UNITED STATES SECRET SERVICE (USSS)</p> <p>Type: Entity Subtype Entity/Entity Type: OPERATION/LAW ENFORCEMENT OPERATION Symbol Set Code: 40 Code: 131509 Icon Type: Main</p>		<p>N/A</p>

TABLE G-III. Activities icons - Continued.

DESCRIPTION	ICON	REMARKS
<p>TRANSPORATION SECURITY ADMINISTRATION (TSA)</p> <p>Type: Entity Subtype Entity/Entity Type: OPERATION/LAW ENFORCEMENT OPERATION Symbol Set Code: 40 Code: 131510 Icon Type: Main</p>		<p>N/A</p>
<p>COAST GUARD</p> <p>Type: Entity Subtype Entity/Entity Type: OPERATION/LAW ENFORCEMENT OPERATION Symbol Set Code: 40 Code: 131511 Icon Type: Full Octagon</p>		<p>N/A</p>
<p>US MARSHALS SERVICE</p> <p>Type: Entity Subtype Entity/Entity Type: OPERATION/LAW ENFORCEMENT OPERATION Symbol Set Code: 40 Code: 131512 Icon Type: Full Octagon</p>		<p>N/A</p>
<p>INTERNAL SECURITY FORCE</p> <p>Type: Entity Subtype Entity/Entity Type: OPERATION/LAW ENFORCEMENT OPERATION Symbol Set Code: 40 Code: 131513 Icon Type: Main</p>		<p>N/A</p>
<p>FIRE EVENT</p> <p>Type: Entity Symbol Set Code: 40 Code: 140000 Icon Type: Full Octagon</p>		
<p>FIRE ORIGIN</p> <p>Type: Entity Type Entity/Entity Type: FIRE EVENT Symbol Set Code: 40 Code: 140100 Icon Type: Full Octagon</p>		<p>N/A</p>

TABLE G-III. Activities icons - Continued.

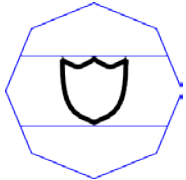





DESCRIPTION	ICON	REMARKS
<p>SMOKE</p> <p>Type: Entity Type Entity/Entity Type: FIRE EVENT Symbol Set Code: 40 Code: 140200 Icon Type: Full Octagon</p>		<p>N/A</p>
<p>HOT SPOT</p> <p>Type: Entity Type Entity/Entity Type: FIRE EVENT Symbol Set Code: 40 Code: 140300 Icon Type: Full Octagon</p>		<p>N/A</p>
<p>NON-RESIDENTIAL FIRE</p> <p>Type: Entity Type Entity/Entity Type: FIRE EVENT Symbol Set Code: 40 Code: 140400 Icon Type: Full Octagon</p>		<p>N/A</p>
<p>RESIDENTIAL FIRE</p> <p>Type: Entity Type Entity/Entity Type: FIRE EVENT Symbol Set Code: 40 Code: 140500 Icon Type: Full Octagon</p>		<p>N/A</p>
<p>SCHOOL FIRE</p> <p>Type: Entity Type Entity/Entity Type: FIRE EVENT Symbol Set Code: 40 Code: 140600 Icon Type: Full Octagon</p>		<p>N/A</p>
<p>SPECIAL NEEDS FIRE</p> <p>Type: Entity Type Entity/Entity Type: FIRE EVENT Symbol Set Code: 40 Code: 140700 Icon Type: Full Octagon</p>		<p>N/A</p>
<p>WILD FIRE</p> <p>Type: Entity Subtype Entity/Entity Type: INCIDENT/FIRE EVENT Symbol Set Code: 40 Code: 140800 Icon Type: Full Octagon</p>		<p>N/A</p>

TABLE G-III. Activities icons - Continued.





DESCRIPTION	ICON	REMARKS
<p>HAZARDOUS MATERIALS</p> <p>Type: Entity Symbol Set Code: 40 Code: 150000</p>	<p>N/A</p>	<p>No icon is associated with this entity. It is for hierarchal purposes only.</p>
<p>HAZARDOUS MATERIALS INCIDENT</p> <p>Type: Entity Type Entity: INCIDENT Symbol Set Code: 40 Code: 150100 Icon Type: Full Octagon</p>		<p>N/A</p>
<p>CHEMICAL AGENT</p> <p>Type: Entity Subtype Entity/Entity Type: HAZARDOUS MATERIALS /HAZARDOUS MATERIALS INCIDENT Symbol Set Code: 40 Code: 150101 Icon Type: Full Octagon</p>		<p>N/A</p>
<p>CORROSIVE MATERIAL</p> <p>Type: Entity Subtype Entity/Entity Type: HAZARDOUS MATERIALS /HAZARDOUS MATERIALS INCIDENT Symbol Set Code: 40 Code: 150102 Icon Type: Full Octagon</p>		<p>N/A</p>
<p>HAZARDOUS WHEN WET</p> <p>Type: Entity Subtype Entity/Entity Type: HAZARDOUS MATERIALS /HAZARDOUS MATERIALS INCIDENT Symbol Set Code: 40 Code: 150103 Icon Type: Full Octagon</p>		<p>N/A</p>
<p>EXPLOSIVE MATERIAL</p> <p>Type: Entity Subtype Entity/Entity Type: HAZARDOUS MATERIALS /HAZARDOUS MATERIALS INCIDENT Symbol Set Code: 40 Code: 150104 Icon Type: Full Octagon</p>		<p>N/A</p>

TABLE G-III. Activities icons - Continued.



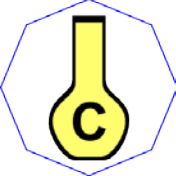

DESCRIPTION	ICON	REMARKS
<p>FLAMMABLE GAS</p> <p>Type: Entity Subtype Entity/Entity Type: HAZARDOUS MATERIALS /HAZARDOUS MATERIALS INCIDENT Symbol Set Code: 40 Code: 150105 Icon Type: Full Octagon</p>		N/A
<p>FLAMMABLE LIQUID</p> <p>Type: Entity Subtype Entity/Entity Type: HAZARDOUS MATERIALS /HAZARDOUS MATERIALS INCIDENT Symbol Set Code: 40 Code: 150106 Icon Type: Full Octagon</p>		N/A
<p>FLAMMABLE SOLID</p> <p>Type: Entity Subtype Entity/Entity Type: HAZARDOUS MATERIALS /HAZARDOUS MATERIALS INCIDENT Symbol Set Code: 40 Code: 150107 Icon Type: Full Octagon</p>		N/A
<p>NON-FLAMMABLE GAS</p> <p>Type: Entity Subtype Entity/Entity Type: HAZARDOUS MATERIALS /HAZARDOUS MATERIALS INCIDENT Symbol Set Code: 40 Code: 150108 Icon Type: Full Octagon</p>		N/A
<p>ORGANIC PEROXIDE</p> <p>Type: Entity Subtype Entity/Entity Type: HAZARDOUS MATERIALS /HAZARDOUS MATERIALS INCIDENT Symbol Set Code: 40 Code: 150109 Icon Type: Full Octagon</p>		N/A

TABLE G-III. Activities icons - Continued.



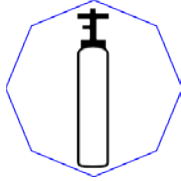

DESCRIPTION	ICON	REMARKS
<p>OXIDIZER</p> <p>Type: Entity Subtype Entity/Entity Type: HAZARDOUS MATERIALS /HAZARDOUS MATERIALS INCIDENT Symbol Set Code: 40 Code: 150110 Icon Type: Full Octagon</p>		N/A
<p>RADIOACTIVE MATERIAL</p> <p>Type: Entity Subtype Entity/Entity Type: HAZARDOUS MATERIALS /HAZARDOUS MATERIALS INCIDENT Symbol Set Code: 40 Code: 150111 Icon Type: Full Octagon</p>		N/A
<p>SPONTANEOUSLY COMBUSTIBLE MATERIAL</p> <p>Type: Entity Subtype Entity/Entity Type: HAZARDOUS MATERIALS /HAZARDOUS MATERIALS INCIDENT Symbol Set Code: 40 Code: 150112 Icon Type: Full Octagon</p>		N/A
<p>TOXIC GAS</p> <p>Type: Entity Subtype Entity/Entity Type: HAZARDOUS MATERIALS /HAZARDOUS MATERIALS INCIDENT Symbol Set Code: 40 Code: 150113 Icon Type: Full Octagon</p>		N/A
<p>TOXIC INFECTIOUS MATERIAL</p> <p>Type: Entity Subtype Entity/Entity Type: INCIDENT/HAZARDOUS MATERIALS INCIDENT Symbol Set Code: 40 Code: 150114 Icon Type: Full Octagon</p>		N/A

TABLE G-III. Activities icons - Continued.

DESCRIPTION	ICON	REMARKS
<p>UNEXPLODED ORDNANCE</p> <p>Type: Entity Subtype Entity/Entity Type: INCIDENT/HAZARDOUS MATERIALS INCIDENT Symbol Set Code: 40 Code: 150115 Icon Type: Full Octagon</p>		<p>N/A</p>
<p>TRANSPORTATION INCIDENT</p> <p>Type: Entity Symbol Set Code: 40 Code: 160000 Icon Type: Full Octagon</p>		<p>This symbol shall not be displayed on a C2 system but may be displayed for training or hierarchal explanation purposes.</p>
<p>AIR</p> <p>Type: Entity Type Entity: TRANSPORTATION INCIDENT Symbol Set Code: 40 Code: 160100 Icon Type: Main</p>		<p>N/A</p>
<p>MARINE</p> <p>Type: Entity Type Entity: TRANSPORTATION INCIDENT Symbol Set Code: 40 Code: 160200 Icon Type: Main</p>		<p>N/A</p>
<p>RAIL</p> <p>Type: Entity Type Entity: TRANSPORTATION INCIDENT Symbol Set Code: 40 Code: 160300 Icon Type: Main</p>		<p>N/A</p>
<p>VEHICLE</p> <p>Type: Entity Type Entity: TRANSPORTATION INCIDENT Symbol Set Code: 40 Code: 160400 Icon Type: Main</p>		<p>N/A</p>

TABLE G-III. Activities icons - Continued.



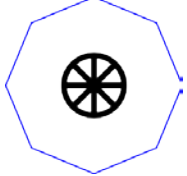
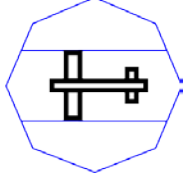
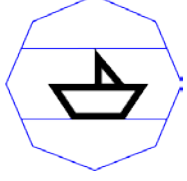
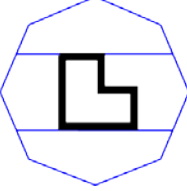
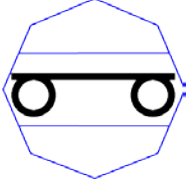

DESCRIPTION	ICON	REMARKS
<p>WHEELED VEHICLE EXPLOSION</p> <p>Type: Entity Type Entity: TRANSPORTATION INCIDENT Symbol Set Code: 40 Code: 160500 Icon Type: Full Octagon</p>		<p>N/A</p>
<p>NATURAL EVENT</p> <p>Type: Entity Symbol Set Code: 40 Code: 170000 Icon Type: Main</p>		<p>This symbol shall not be displayed on a C2 system but may be displayed for training or hierarchal explanation purposes.</p>
<p>GEOLOGIC</p> <p>Type: Entity Type Entity: NATURAL EVENT Symbol Set Code: 40 Code: 170100 Icon Type: Main</p>		<p>This symbol shall not be displayed on a C2 system but may be displayed for training or hierarchal explanation purposes.</p>
<p>AFTERSHOCK</p> <p>Type: Entity Subtype Entity/Entity Type: NATURAL EVENT/GEOLOGIC Symbol Set Code: 40 Code: 170101 Icon Type: Full Octagon</p>		<p>N/A</p>
<p>AVALANCHE</p> <p>Type: Entity Subtype Entity/Entity Type: NATURAL EVENT/GEOLOGIC Symbol Set Code: 40 Code: 170102 Icon Type: Full Octagon</p>		<p>N/A</p>
<p>EARTHQUAKE EPICENTER</p> <p>Type: Entity Subtype Entity/Entity Type: NATURAL EVENT/GEOLOGIC Symbol Set Code: 40 Code: 170103 Icon Type: Full Octagon</p>		<p>N/A</p>

TABLE G-III. Activities icons - Continued.



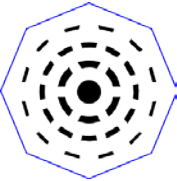

DESCRIPTION	ICON	REMARKS
<p>LANDSLIDE</p> <p>Type: Entity Subtype Entity/Entity Type: NATURAL EVENT/GEOLOGIC Symbol Set Code: 40 Code: 170104 Icon Type: Full Octagon</p>		<p>N/A</p>
<p>SUBSIDENCE</p> <p>Type: Entity Subtype Entity/Entity Type: NATURAL EVENT/GEOLOGIC Symbol Set Code: 40 Code: 170105 Icon Type: Full Octagon</p>		<p>N/A</p>
<p>VOLCANIC ERUPTION</p> <p>Type: Entity Subtype Entity/Entity Type: NATURAL EVENT/GEOLOGIC Symbol Set Code: 40 Code: 170106 Icon Type: Full Octagon</p>		<p>N/A</p>
<p>VOLCANIC THREAT</p> <p>Type: Entity Subtype Entity/Entity Type: NATURAL EVENT/GEOLOGIC Symbol Set Code: 40 Code: 170107 Icon Type: Full Octagon</p>		<p>N/A</p>
<p>CAVE ENTRANCE</p> <p>Type: Entity Subtype Entity/Entity Type: NATURAL EVENT/GEOLOGIC Symbol Set Code: 40 Code: 170108 Icon Type: Full Octagon</p>		<p>N/A</p>
<p>HYDRO-METEOROLOGICAL</p> <p>Type: Entity Type Entity: NATURAL EVENT Symbol Set Code: 40 Code: 170200 Icon Type: Main</p>		<p>This symbol shall not be displayed on a C2 system but may be displayed for training or hierarchal explanation purposes.</p>

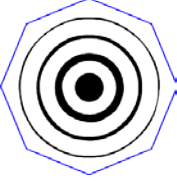
TABLE G-III. Activities icons - Continued.



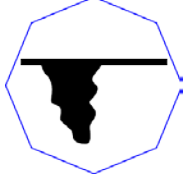

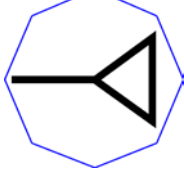





DESCRIPTION	ICON	REMARKS
<p>DROUGHT</p> <p>Type: Entity Subtype Entity/Entity Type: NATURAL EVENT/HYDRO- METEOROLOGICAL Symbol Set Code: 40 Code: 170201 Icon Type: Full Octagon</p>		N/A
<p>FLOOD</p> <p>Type: Entity Subtype Entity/Entity Type: NATURAL EVENT/HYDRO- METEOROLOGICAL Symbol Set Code: 40 Code: 170202 Icon Type: Full Octagon</p>		N/A
<p>TSUNAMI</p> <p>Type: Entity Subtype Entity/Entity Type: NATURAL EVENT/HYDRO- METEOROLOGICAL Symbol Set Code: 40 Code: 170203 Icon Type: Full Octagon</p>		N/A
<p>INFESTATION</p> <p>Type: Entity Type Entity: NATURAL EVENT Symbol Set Code: 40 Code: 170300 Icon Type: Main</p>		This symbol shall not be displayed on a C2 system but may be displayed for training or hierarchal explanation purposes.
<p>BIRD</p> <p>Type: Entity Subtype Entity/Entity Type: NATURAL EVENT/INFESTATION Symbol Set Code: 40 Code: 170301 Icon Type: Full Octagon</p>		N/A
<p>INSECT</p> <p>Type: Entity Subtype Entity/Entity Type: NATURAL EVENT/INFESTATION Symbol Set Code: 40 Code: 170302 Icon Type: Full Octagon</p>		N/A

TABLE G-III. Activities icons - Continued.

DESCRIPTION	ICON	REMARKS
<p>MICROBIAL</p> <p>Type: Entity Subtype Entity/Entity Type: NATURAL EVENT/INFESTATION Symbol Set Code: 40 Code: 170303 Icon Type: Full Octagon</p>		<p>N/A</p>
<p>REPTILE</p> <p>Type: Entity Subtype Entity/Entity Type: NATURAL EVENT/INFESTATION Symbol Set Code: 40 Code: 170304 Icon Type: Full Octagon</p>		<p>N/A</p>
<p>RODENT</p> <p>Type: Entity Subtype Entity/Entity Type: NATURAL EVENT/INFESTATION Symbol Set Code: 40 Code: 170305 Icon Type: Full Octagon</p>		<p>N/A</p>
<p>INDIVIDUAL</p> <p>Type: Entity Symbol Set Code: 40 Code: 180000</p>	<p>N/A</p>	<p>No icon is associated with this entity. It is for hierarchal purposes only.</p>
<p>RELIGIOUS LEADER</p> <p>Type: Entity Type Entity: INDIVIDUAL Symbol Set Code: 40 Code: 180100 Icon Type: Full Octagon</p>		<p>N/A</p>
<p>SPEAKER</p> <p>Type: Entity Type Entity: INDIVIDUAL Symbol Set Code: 40 Code: 180200 Icon Type: Full Octagon</p>		<p>N/A</p>

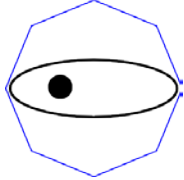
G.6.3 Activities sector 1 modifiers. Activities sector 1 modifiers denote crime, military information support operations, IED and incident qualifier categories. [Table G-IV](#) lists activities sector 1 modifiers and illustrates their placement within the bounding octagon.

TABLE G-IV. Activities sector 1 modifiers.





DESCRIPTION	CATEGORY	MODIFIER	REMARKS
ASSASSINATION Symbol Set Code: 40 Code: 01	CRIME		N/A
EXECUTION (WRONGFUL KILLING) Symbol Set Code: 40 Code: 02	CRIME		N/A
HIJACKING/HIJACKED Symbol Set Code: 40 Code: 03	CRIME		N/A
HOUSE-TO-HOUSE Symbol Set Code: 40 Code: 04	MILITARY INFORMATION SUPPORT OPERATIONS		N/A
KIDNAPPING Symbol Set Code: 40 Code: 05	CRIME		N/A
MURDER Symbol Set Code: 40 Code: 06	CRIME		N/A
PIRACY Symbol Set Code: 40 Code: 07	CRIME		N/A

TABLE G-IV. Activities sector 1 modifiers - Continued.

DESCRIPTION	CATEGORY	MODIFIER	REMARKS
RAPE Symbol Set Code: 40 Code: 08	CRIME		N/A
WRITTEN MILITARY INFORMATION SUPPORT OPERATIONS Symbol Set Code: 40 Code: 09	MILITARY INFORMATION SUPPORT OPERATIONS		N/A
PIRATE Symbol Set Code: 40 Code: 10	CRIME		N/A
FALSE Symbol Set Code: 40 Code: 11	IED CATEGORY		N/A
FIND Symbol Set Code: 40 Code: 12	IED CATEGORY		N/A
FOUND AND CLEARED Symbol Set Code: 40 Code: 13	IED CATEGORY		N/A
HOAX (DECOY) Symbol Set Code: 40 Code: 14	IED CATEGORY		N/A
ATTEMPTED Symbol Set Code: 40 Code: 15	INCIDENT QUALIFIER		N/A

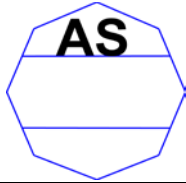
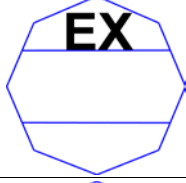
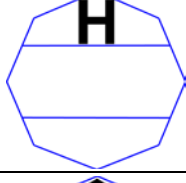
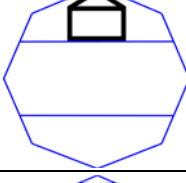
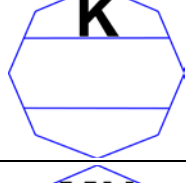
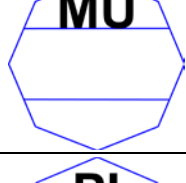
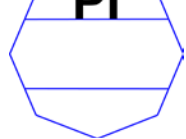
MIL-STD-2525D - APPENDIX G

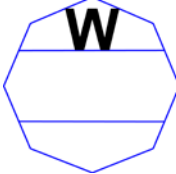
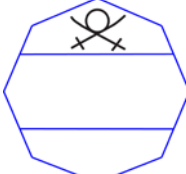
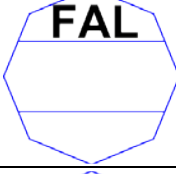
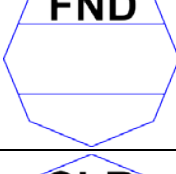
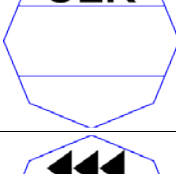
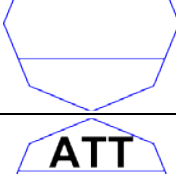
TABLE G-IV. Activities sector 1 modifiers - Continued.

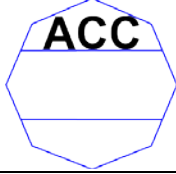
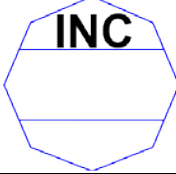
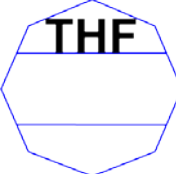
DESCRIPTION	CATEGORY	MODIFIER	REMARKS
ACCIDENT Symbol Set Code: 40 Code: 16	INCIDENT QUALIFIER		N/A
INCIDENT Symbol Set Code: 40 Code: 17	INCIDENT QUALIFIER		N/A
THEFT Symbol Set Code: 40 Code: 18	CRIME		N/A

PAGE INTENTIONALLY LEFT BLANK

APPENDIX H - CONTROL MEASURE SYMBOLS

H.1 SCOPE

H.1.1 Scope. This appendix addresses symbols that support control measures as well as symbols for chemical, biological, radiological and nuclear (CBRN) incidents in the C2 domain. The tables in this appendix present the icons and amplifiers for control measures and CBRN. This appendix is a mandatory part of the standard. The information contained herein is intended for compliance. Ultimately, the joint force commander and his forces must be capable of accomplishing their mission, either directly or indirectly, by the employment of capabilities to create physical or psychological effects and be able to sustain such operations for as long as is necessary to achieve operational objectives. The principal method by which this capability is delivered is through the combination of joint operational capabilities and a range of mechanisms and control measures. This appendix establishes a standard system for the development and use of control measures symbols. Within this standard system there are series of control measure symbols that follow standard formats and there are control measure symbols that follow stand alone formats. This appendix provides rules for automated and hand-drawn symbols and examples for all control measure symbols. These control measure symbols are the standard for all command and control systems and simulations, including those used in live, virtual and planning. For many control measure symbols, there is a corresponding definition provided in this section. These definitions are provided to help add clarity in using these symbols. For ease of understanding and use the control measure symbols have been broken down into groups that correspond to the joint functions of command and control to include joint targeting, maneuver and fires, intelligence, force protection, sustainment and deception under information operations.

H.2 APPLICABLE DOCUMENTS

Specific documents in [2.2](#) of this standard apply to this appendix.

H.3 DEFINITIONS

The definitions in [section 3](#) of this standard apply to this appendix.

H.4 GENERAL REQUIREMENTS

H.4.1 Organization. This appendix contains technical specifications, a symbol coding scheme, a symbology hierarchy and control measures symbology.

H.5 DETAILED REQUIREMENTS

H.5.1 Control measure symbols. Control measures are directives given to assign responsibilities, coordinate fires and maneuvers and control operations. They may be boundaries, special area designations and other unique markings related to operational environment geometry and necessary for planning and management of operations. Control measure symbols provide operational information that cannot be displayed via icon-based symbols alone. Control measures can be displayed as points, lines, areas, or tactical mission tasks.

H.5.1.1 Composition of control measure symbols. Control measure symbols can be combined with other symbols, icons and amplifiers to display operational information (see figure H-1). They do not follow the same building rules as the icon-based symbols but shall be built in accordance with the rules specified in the control measure appendix.



CONTROL MEASURE COMPONENTS		COMPLETED CONTROL MEASURE SYMBOL
 <p>CONTROL MEASURE</p>	 <p>ICON-BASED SYMBOL WITH AMPLIFIERS</p>	
CONTROL MEASURE COMPONENTS		COMPLETED CONTROL MEASURE SYMBOL
 <p>CONTROL MEASURE</p>	<p>GOLD EFF 032200JUL</p> <p>AMPLIFIER</p>	

FIGURE H-1. Composition of control measure symbols.

H.5.1.1.1 Standard identity (color rules) for control measure symbols. The control measure symbols for monochrome systems shall be black or white, depending on display background. For color systems, control measures shall be black, blue (friendly), red (hostile), green (neutral or obstacles), or yellow (unknown or chemical, biological, radiological and nuclear cross-hatched contaminated area fill). If red is not available for hostile standard identity, the graphic shall be drawn in black with the abbreviation “ENY” placed on the graphic in at least two places for linear and multi point control measures and in one place for single point control measures.

H.5.1.1.2 Point control measure height. Unless specifically indicated otherwise in the size/shape parameter of a point control measure’s notes, the default point control measure symbol height should be 1L, where L is the default length and height of the bounding octagon (see 5.3.1).

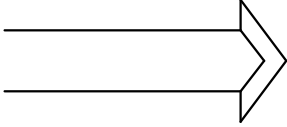
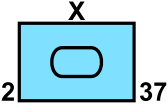
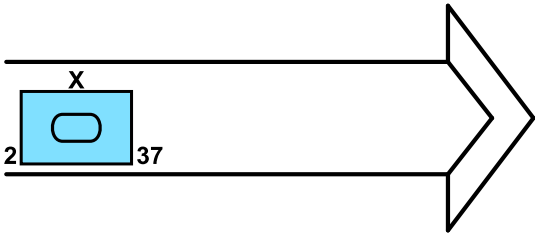
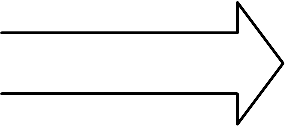
H.5.1.1.3 Status. Status refers to whether a control measure exists at the location identified (status is “present”) or will in the future reside at that location (status is “planned”, “anticipated”, “suspected”, or “on order”). If a control measure is on order, the status code shall be specified “A – Anticipated/Planned” and field amplifier “W” shall be present and specified “O/O”. In general, linear control measures (including boundary lines) and area control measures shall be a solid line when indicating present status and a dashed line when indicating anticipated or planned status, as depicted in Table H-I. There are certain control measures such as counterattack which are drawn in the “present” status with dashed lines. The codes for status in the SIDC are provided in the appendix for each symbology set.

TABLE H-I. Present and planned status for control measures symbols.

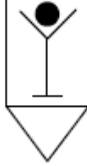
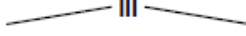
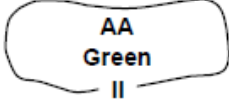
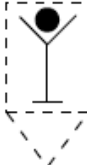
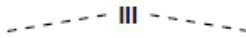
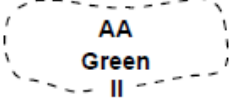
	POINT GRAPHICS	BOUNDARY LINE GRAPHICS	AREA GRAPHICS
PRESENT POSITION (P)			22040000ZJAN99 24040000ZJAN99 
ANTICIPATED, PLANNED, SUSPECTED, OR ON ORDER (A)			

H.5.1.1.4 Amplifiers. An amplifier provides optional additional information about a tactical symbol. The field ID, field title, description and maximum allowable display lengths of tactical symbol amplifiers are presented in [table H-II](#). An example of each amplifier (both text and graphic indicators) is included in [figure H-2](#). The default placement of amplifiers in fields for boundaries, points, lines and areas are shown in figures [H-3](#), [H-4](#), [H-5](#) and [H-6](#), respectively. An example of chemical, biological, radiological and nuclear (CBRN) events can be seen in [table H-XIX](#). As indicated in figures [H-3](#), [H-4](#), [H-5](#) and [H-6](#), certain fields can be displayed more than once within a tactical symbol. In some cases, a tactical symbol may require multiple instances of a given amplifier in order to fully create or represent an object: examples of these fields are H, T, W and Y. The unnumbered fields should be filled before the numbered fields (i.e., fields W, H and T should be used before fields W1, H1 and T1). As indicated in [table II](#), not all amplifiers are applicable to all tactical symbols. However, when any such amplifier is displayed, it shall be defined in accordance with the contents of this table and positioned in accordance with figures [H-3](#), [H-4](#), [H-5](#), [H-6](#) and [table H-XIX](#).

TABLE H-II. Amplifier descriptions and maximum lengths for control measure symbols.

FIELD ID	FIELD TITLE	DESCRIPTION	P ¹	L ¹	A ¹	BL ¹	B/C ¹	R/N ¹
A	Symbol Icon	The innermost part of a symbol that represents a joint military object (see 5.3.4).	G ²	G	G	G	G	G
B	Echelon	A graphic amplifier in a unit symbol that identifies command level (see tables D-III and D-V in the Land appendix and figure H-3 and figure H-6).	-	G	G	G	-	-
C	Quantity	A text amplifier in an equipment symbol that identifies the number of items present.	-	-	-	-	-	6 ²

TABLE H-II. Amplifier descriptions and maximum lengths for control measure symbols - Continued.

FIELD ID	FIELD TITLE	DESCRIPTION	P ¹	L ¹	A ¹	BL ¹	B/C ¹	R/N ¹
H	Additional Information	AError! Bookmark not defined. text amplifier for control measure symbols; content is implementation specific.	20	20	20	-	20	20
N	Hostile (Enemy)	A text amplifier for control measure symbols; the letters "ENY" denote hostile control measure symbols.	3	3	3	3	3	3
Q	Direction of Movement Indicator	A graphic amplifier for events that identifies the direction of movement (see H.5.1.1.5 and table XIX).	-	-	-	-	G	G
S	Offset Location Indicator	A graphic amplifier for points and CBRN events used when placing an object away from its actual location (see H.5.1.1.7 and figures H-2 , H-3 , H-4 , H-5 , H-6 and table XIX).	G	-	-	-	G	G
T	Unique Designation	A text amplifier that uniquely identifies a particular control measure symbol; target number. Nuclear: delivery unit (missile, aircraft, satellite, etc.)	30	30	30	30	30	30
V	Type	A text amplifier for equipment that indicates types of equipment or nuclear weapon type.	20	20	20		20	20
W ³	Date/Time Group (DTG)	An alphanumeric designator for displaying a date-time group (DDHHMMSSZMONYYYY) or "O/O" for on order. The date-time group is composed of a group of six numeric digits with a time zone suffix and the standardized three-letter abbreviation for the month followed by four digits. The first pair of digits represents the day; the second pair, the hour; the third pair, the minutes. The last four digits after the month are the year. For automated systems, two digits may be added before the time zone suffix and after the minutes to designate seconds.	16	16	16	-	16	16
X	Altitude / Depth	A text amplifier that displays the minimum, maximum and/or specific altitude (in feet or meters in relation to a reference datum), flight level, or depth (for submerged objects in feet below sea level). See H.5.1.1.9 for content.	14	14	14	-	14	14
Y	Location	A text amplifier that displays a graphic's location in degrees, minutes and seconds (or in UTM or other applicable display format).	19	19	19	19	19	19
AM	Distance	A numeric amplifier that displays a minimum, maximum, or a specific distance (range, radius, width, length, etc.), in meters.	6	6	6	-	-	-
AN	Azimuth	A numeric amplifier that displays an angle measured from true north to any other line in degrees.	3	3	3	-	-	-

TABLE H-II. Amplifier descriptions and maximum lengths for control measure symbols - Continued.

FIELD ID	FIELD TITLE	DESCRIPTION	P ¹	L ¹	A ¹	BL ¹	B/C ¹	R/N ¹
AP	Target Designator	A six character text modifier used in Fire Support operations to uniquely designate targets in accordance with STANAG 2147, where characters 1 and 2 are alphabetic, and characters 3-6 are numeric: AANNNN.	6	6	6	-	-	-
AS	Country	Identifies the country of the organization being shown.	-	3	-	3	-	-

Notes: 1. Column headings: P = points, L = lines, A = areas, BL = boundary lines, R/N = radiological/nuclear, B/C = biological/chemical.
 2. Numeric entry indicates text amplifier. "G" indicates graphic amplifier. A dash (-) inside boxes indicates non-applicable.
 3. Field W: D = day, H = hour, M = minute, S = second, Z = time zone suffix, MON = month and Y = year.

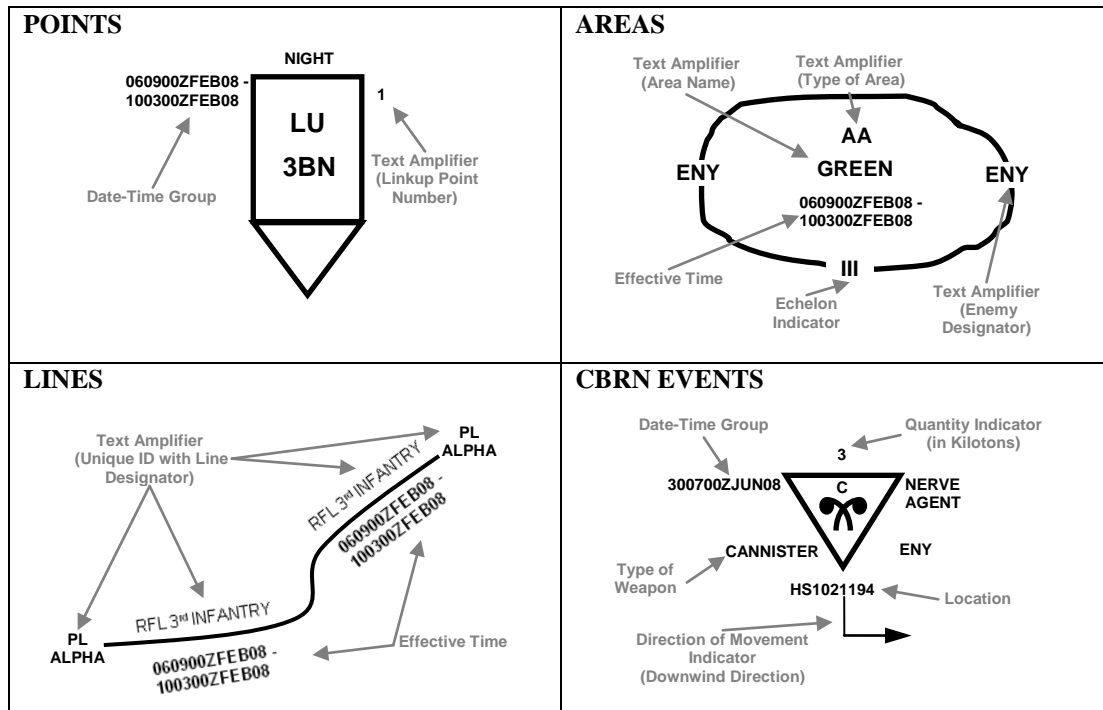

FIGURE H-2. Graphic amplifiers for control measure symbols.

H.5.1.1.5 Direction of movement indicator. The direction of movement indicator is an arrow identifying the direction of movement of events. The arrow extends downward from the center of the icon and points in the direction of movement. The indicator is represented in field Q as defined in [table II](#) and positioned as shown in [table XIX](#).

H.5.1.1.6 Echelon indicator. The echelon indicator provides a graphic representation of command level and is used to show the element echelon on boundary lines, lines and areas. Echelon indicator codes are listed in [table D-III](#) of the land appendix. The indicator is represented in field B as defined in [table H-II](#) and positioned as shown in [figure H-2](#) and [figure H-6](#).

H.5.1.1.7 Offset location indicator. The offset location indicator is used when placing an object away from its actual location. The indicator is a line extending downward from an appropriate anchor point on an icon. The actual location (field Y) is given in latitude and longitude. The indicator is represented in field S in [table H-II](#) and positioned as shown in figures [H-2](#), [H-3](#), [H-4](#), [H-5](#), [H-6](#) and [table H-XIX](#).

H.5.1.1.8 Text amplifier. [Table H-II](#) defines the specific content, length and type of each text amplifier. Additional information is contained in field H, with the content of this field being implementation specific, provided the maximum number of characters in each field is not exceeded.

H.5.1.1.9 Altitude/depth amplifier. This field may contain alternate value formats. Enter a description of the altitude/depth (X) using one of the following.

H.5.1.1.10 Altitude base reference point. Legal values are “GL” ground level and “MSL” mean sea level.

H.5.1.1.10.1 Relative altitude. The relative altitude is a composite field consisting of multiple parts, the numeric altitude, the altitude unit of measurement and the altitude vertical dimension. Legal values for the numeric altitude are (minus) -99999 through 99999 in increments of 1. Legal values for altitude units of measure is feet “FT,” meters “M,” kilometers “KM,” and statute miles “SM.” The legal value for the depth unit of measure is feet “FT.” Legal values for the vertical dimension are “AGL” above ground level, “AMSL” above mean sea level, “HAE” height above ellipsoid and “BMSL” below mean sea level. BMSL is used only for depth of submerged objects, reported in feet. A space may be added between the values in the field to make it easier to read.

Examples: 1250 FT AGL, 1000 FT AMSL, 1524 M HAE, 35760 FT BMSL.

H.5.1.1.10.2 Flight level. By definition, flight level (FL) is, “Surfaces of constant atmospheric pressure which are related to a specific pressure datum, 1013.2 mb (29.92 in) and are separated by specific pressure intervals. (Flight levels are expressed in three digits that represent hundreds of feet; e.g., flight level 250 represents a barometric altimeter indication of 25,000 feet and flight level 255 is an indication of 25,500 feet.)” The legal value for flight level indicator is “FL.” A space may be added between the values in the field to make it easier to read. The legal value for context quantity is 000-999, in increments of one.

Example: FL 290.

H.5.1.1.10.3 Multiple instances of altitude/depth amplifiers. When multiple instances of the “X” amplifier are present in a single instance of a symbol or graphic (ex., Minimum Altitude “X,” Maximum Altitude “X1”), for display purposes, the fields may be separated by a hyphen “-,” or a space, hyphen and space “ - .”

Examples:

500 FT AGL – 1250 FT AGL

25 FT AMSL – 150 FT AMSL

FL 250 – FL 290

MSL – 35760 FT BMSL

H.5.1.1.11 Date-time group. Date-time group (DTG) is defined as the date and time expressed in an alphanumeric combination. The alphanumeric combination used is day-time-time zone-month-year. The alphanumeric combination can be displayed in a number of ways. In its longest form, sixteen characters, it is composed of eight digits (first pair of digits denotes the date, second pair denotes the hours, third pair denotes the minutes and fourth pair denotes the seconds) followed by the time zone suffix, followed by a three-letter month abbreviation and four digits for the year: DDHHMMSSZMONYYYY. It can also be expressed in shorter forms by removing characters, such as DDHHMMZMONYY. On order (O/O) is a valid substitute for DTG.

H.5.2 Construction of control measure symbols. The rules for constructing control measure symbols vary depending on whether the object is point, line, or area based. The latter category of objects includes various forms of linear control measure symbols such as boundaries, areas of all shapes and sizes and complex figures such as an air corridor.

H.5.2.1 Point control measure symbols. A point-based control measure symbol, such as a casualty collection point, is constructed in the same manner as an unframed tactical symbol. Rules concerning the relative size of symbol components and placement of amplifiers in tactical symbols also apply to point based control measure symbols.

H.5.2.2 Line and area control measure symbols. A line or area control measure symbol is constructed using the anchor points, size and orientation defined for the control measure symbol. This appendix includes these parameters for the line and area graphics in the C2 domain. The size of the control measure symbol is determined by these parameters and the scale of the background on which the control measure symbols is placed. As a general rule, the line width and pattern height shall be scaled proportionally to the change in icon size required by its change in background scale (map or image). For control measure symbols, line width is dependent on the distance between the points to be depicted and may vary (i.e., be reduced or enlarged) as display scale changes.

H.5.3 Coloring. All friendly control measure symbols will be shown in black or blue when drawn manually or on a color computer-generated display. Hostile control measure symbols shall be shown in red. If red is not available, they will be drawn in black with the abbreviation “ENY” placed on the symbols in one place for single point symbols and at least two places for Area and Line symbols. All obstacles as shown in this appendix, friendly, hostile, neutral, unknown or factional, shall be drawn using the color green. If the color green is not available obstacles should be drawn using black. The color yellow will be used for the cross-hatching for CBRN contaminated areas. NOTE: The use of green and yellow for obstacles and CBRN is in contradiction to the standard identities.

H.5.4 Labeling. All text labeling shall be in upper case letters. The reader should be able to read the labels for all text labels of amplifier fields for control measures symbols when

the bottom of the overlay is closest to the reader. Labeling written on an angle should be readable to the viewer so they do not have to turn their head. Where space is limited within an area, the amplifying information may be shown in a stacked manner, rather than side by side as displayed in the templates.

H.5.4.1 Fonts. Font sizes shall be scaled as appropriate in order for the information to be readable to the viewer.

H.5.5 Command and Control. The exercise of authority and direction by a properly designated commander over assigned and attached forces in the accomplishment of the mission. Command and control functions are performed through an arrangement of personnel, equipment, communications, facilities, and procedures employed by a commander in planning, directing, coordinating, and controlling forces and operations in the accomplishment of the mission.

H.5.5.1 Boundaries. In land warfare, a boundary is a line by which areas of responsibility between adjacent units/formations are defined. For boundaries, all field labels are displayed perpendicular to the boundary line. [Figure H-3](#) “Orientation of Boundary Lines” below provides the orientation of field labels for horizontal (east/west) and vertical (north/south) boundaries. The symbol for the highest echelon (Field B) unit on lateral boundaries is used for the boundary line. The graphic for the lower echelon (Field B) unit on a rear or forward boundary is used for the boundary line ([see Table H-III](#)) When units of the same echelon are adjacent to each other, the abbreviated unique designator (Field T) can be omitted from the alphanumeric designator. Tables [H-XXIII](#) and [H-XXIV](#) at the end of the appendix provide a list of abbreviations and acronyms to be used for Field T. For all boundaries, use Arabic numerals to show the numbers of units, except for a corps boundary, use Roman numerals to show the number of corps. When the boundary is between units of different countries, the country trigraph (Field AS) is shown in parenthesis behind or below the unit designation.

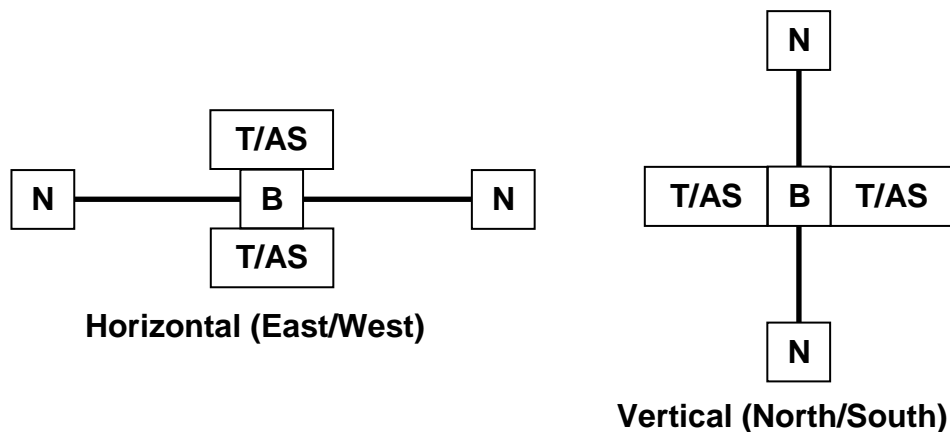

FIGURE H-3. Orientation of boundary lines.

TABLE H-III. Boundaries.

CONTROL MEASURE	TEMPLATE	DRAW RULES	EXAMPLE Note: The symbols that have been colored gray are used to help explain how the control measure is used, but they are not a part of the control measure.
Friendly Present Boundary		<p><u>Anchor Points.</u> This symbol requires at least two points, points 1 and 2, to define the line. Additional points can be defined to extend and shape the line.</p> <p><u>Size/Shape.</u> The first and last anchor points determine the length of the line. The line segment between each pair of anchor points will repeat all information associated with the line segment between points 1 and 2.</p> <p><u>Orientation.</u> Orientation is determined by the anchor points.</p>	<p>2ID (USA)</p> <p>— XX —</p> <p>52ID (GBR)</p>
Friendly Planned or On Order Boundary			<p>1ID (CAN)</p> <p>- - - XX - - -</p> <p>2AD (FRA)</p>
Enemy Known Boundary	<p>Monochrome</p> 		<p>12IN</p> <p>ENY — II — ENY</p> <p>7IN</p>
	<p>Color</p> 		<p>1AAB</p> <p>— X —</p> <p>3ARBN</p>
Enemy Suspected or Templated Boundary	<p>Monochrome</p> 	<p>211AR</p> <p>ENY - - II - - ENY</p> <p>12ARCOY</p>	
	<p>Color</p> 	<p>3ABB</p> <p>- - - X - - -</p> <p>8ABR</p>	

TABLE H-IV. Command and control lines.

BOUNDARY TYPE	EXAMPLE Note: The symbols that have been colored grey are used to help explain how the control measure is used, but they are not a part of the control measure.
Command and Control Lines Symbol Set Code: 25 Code: 110000	N/A
Boundary Symbol Set Code: 25 Code: 110100	see Table H-III and examples below
Lateral Boundary Control measure that defines the left or right limit of a unit's operational area. Together with the rear and forward boundaries and a coordinating altitude, lateral boundaries define the area of operations for a commander.	
Forward Boundary The farthest limit, in the direction of the enemy, of an organization's responsibility.	

TABLE H-IV. Command and control lines - Continued.

BOUNDARY TYPE	EXAMPLE Note: The symbols that have been colored grey are used to help explain how the control measure is used, but they are not a part of the control measure.
<p>Rear Boundary</p> <p>Line that defines the rear area of operations assigned to a particular unit. The area behind the rear boundary belongs to the next higher commander and positioning of elements behind it must be coordinated with that commander.</p>	

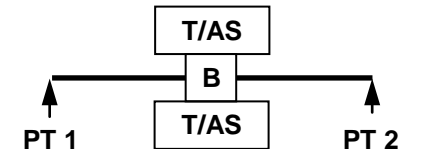
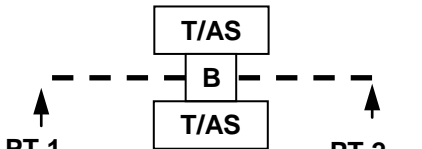
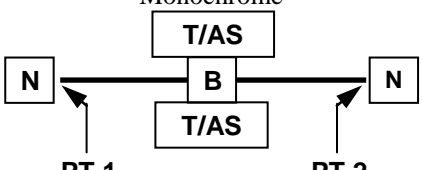
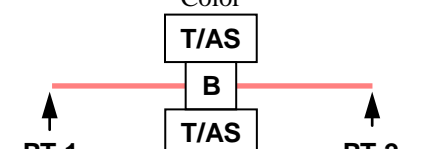
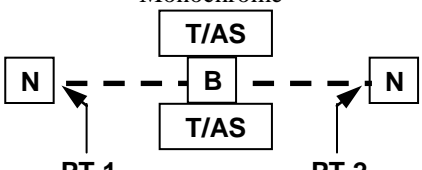
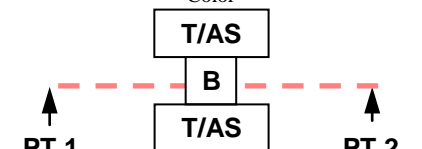
CONTROL MEASURE	TEMPLATE	DRAW RULES	EXAMPLE Note: The symbols that have been colored grey are used to help explain how the control measure is used, but they are not a part of the control measure.
<p>Light Line</p> <p>Designated line forward of which vehicles are required to use black-out lights at night.</p> <p>Symbol Set Code: 25 Code: 110200</p>			

H.5.6 Points. In a number of tables (sustainment, CBRN decontamination and special C2) that follow there are single point control measure symbols that follow a specific format as shown in [Figure H-4](#) below. Supply points follow this same format with a modification to the symbol. Supply points use the same icon used for supply units. The supply icon is placed toward the bottom of the box as shown in [Figure H-4](#) below. This is format for use only with these types of points, as there are other points (contact, coordination, decision, targets, etc.) as displayed throughout this section on land control measure symbols that are formatted differently. In building points, the type of point is abbreviated and positioned inside the top part of the point symbol in field A. For supply symbols this may be a graphic depiction. In addition, below the abbreviation of the point name, the designation of the unit servicing that point may be included in field T1. To differentiate points, the point is numbered, lettered, or a combination. The

number, letter or combination is placed on the outside of the symbol on the right side at the top in field T. On the outside of the point on the left side at the top and middle, date-time groups can be associated with the point. On the outside of the point at the top, additional information can be provided in field H. Text will not be written on an angle for single point symbols. For dynamic displays, if the system has the capability to rotate the map display in the direction of movement, a single point symbol may optionally be rotated on its anchor point.

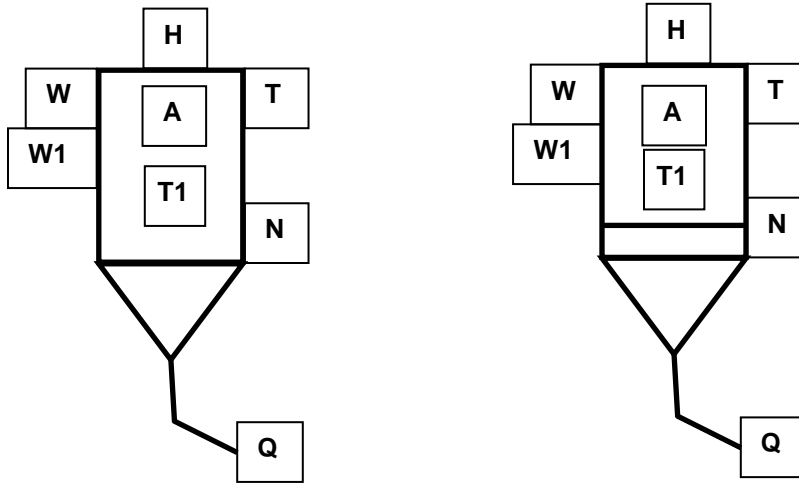

FIGURE H-4. Template for point (left) and supply point (right) control measure symbols.

H.5.7 Lines. In the tables that follow there are line control measure symbols that follow a specific format as shown in [Figure H-5](#) below. Most lines are also named as a phase line for easy reference for use in orders and during transmissions. A phase line will be marked as PL with the name in the T field. Other lines that have a specific purpose and are also named as phase lines should have the primary purpose in the T1 field (such as restrictive fire line “RFL”) labeled on top of the line at both ends of the line inside the lateral boundaries or as often as necessary for clarity. The T2 field is used for fire support coordination measures to show the designation of the controlling headquarters. The use of phase lines to mark line control measure symbols is not mandatory.

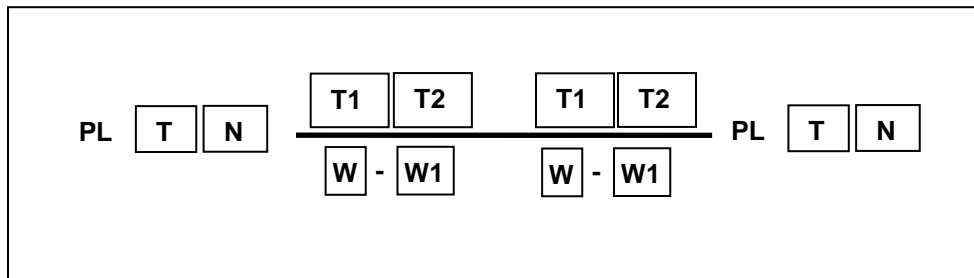

FIGURE H-5. Template for line control measure symbols.

H.5.8 Areas. In the tables that follow there are area control measure symbols that follow a specific format as shown in [Figure H-6](#). Areas will normally be marked with the abbreviation for the type of area in the A field followed by a name in the T field. This labeling should be in

the center of the area unless the area is too small or the labeling would interfere with the locating of units. Not all fields are required for each area; some areas may use only one field, while other will use several.

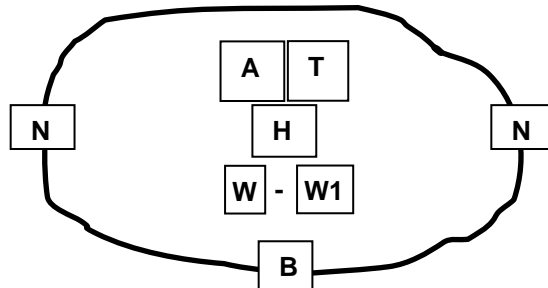

FIGURE H-6. Template for area control measure symbols.

H.5.9 Area of operations. An area of operations is an operational area defined by a joint commander for land or maritime forces to conduct military activities. Normally, an area of operations does not encompass the entire joint operations area of the joint commander, but is sufficient in size for the joint force component commander to accomplish assigned missions and protect forces. Operational area is an overarching term encompassing more descriptive terms for geographic areas in which military operations are conducted. Operational areas include, but are not limited to, such descriptors as area of responsibility, theatre of war, theatre of operations, joint operations area, amphibious objective area, joint special operations area and area of operations.

TABLE H-V. Command and control areas.





CONTROL MEASURE	TEMPLATE	DRAW RULES	EXAMPLE Note: The symbols that have been colored grey are used to help explain how the control measure is used, but they are not a part of the control measure.
Command and Control Areas Symbol Set Code: 25 Code: 120000	N/A		N/A
Area of Operations Symbol Set Code: 25 Code: 120100		<u>Anchor Points.</u> This symbol requires at least three anchor points to define the boundary of the area. Add as	

TABLE H-V. Command and control areas - Continued.

CONTROL MEASURE	TEMPLATE	DRAW RULES	EXAMPLE Note: The symbols that have been colored grey are used to help explain how the control measure is used, but they are not a part of the control measure.
<p>Named Area of Interest</p> <p>A geographical area where information is gathered to satisfy specific intelligence requirements.</p> <p>Symbol Set Code: 25 Code: 120200</p>		<p>many points as necessary to accurately reflect the area's size and shape. <u>Size/Shape.</u> Determined by the anchor points. The information fields should be moveable and scalable as a block within the area.</p> <p><u>Orientation.</u> Not applicable.</p> <p>Static/Dynamic: D</p>	
<p>Target Area of Interest</p> <p>The geographical area where high-value targets can be acquired and engaged by friendly forces.</p> <p>Symbol Set Code: 25 Code: 120300</p>		<p>Static/Dynamic: D</p>	
<p>Airfield Zone</p> <p>Symbol Set Code: 25 Code: 120400</p> <p>Static/Dynamic: D</p>	 <p>Note: The Field "H" for this symbol includes type of airfield, length of runway and other pertinent information.</p>	<p><u>Anchor Points.</u> This symbol requires at least three anchor points to define the boundary of the area. Add as many points as necessary to accurately reflect the area's size and shape. <u>Size/Shape.</u> Determined by the anchor points. <u>Orientation.</u> Not applicable.</p>	

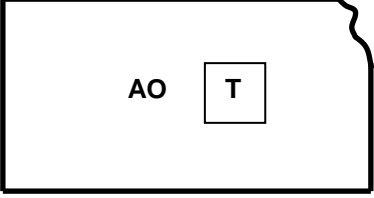
H.5.10 Command and control measure symbols. These symbols are used in the exercise of authority and direction by a properly designated commander over assigned and attached forces in the accomplishment of the mission.

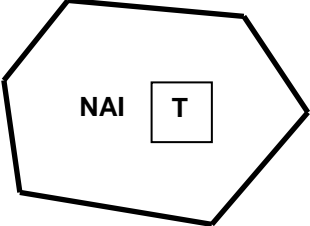
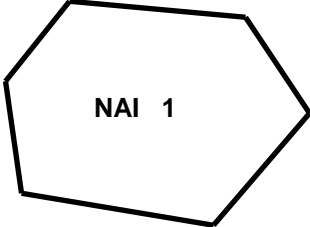
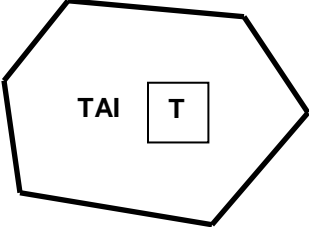
TABLE H-VI. Command and Control points.

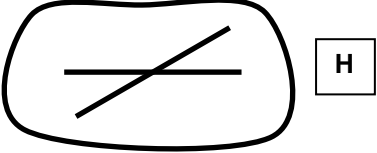
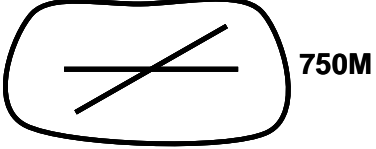
CONTROL MEASURE	TEMPLATE	DRAW RULES	EXAMPLE Note: The symbols that have been colored grey are used to help explain how the control measure is used, but they are not a part of the control measure.
Command and Control Points Type: Entity Symbol Set Code: 25 Code: 130000	N/A		N/A
Action Points (General) Symbol Set Code: 25 Code: 130100		<u>Anchor Points.</u> This symbol requires one anchor point. The point defines the tip of the inverted cone. <u>Size/Shape.</u> Static. <u>Orientation.</u> The symbol will typically be oriented upright, as shown in the example to the right.	Examples follow.
Amnesty Point Symbol Set Code: 25 Code: 130200		Static/Dynamic: S	<div style="text-align: center;"> WEAPONS 080700ZMAY08 - 120700ZMAY08 </div> 

TABLE H-VI. Command and Control points - Continued.

CONTROL MEASURE	TEMPLATE	DRAW RULES	EXAMPLE Note: The symbols that have been colored grey are used to help explain how the control measure is used, but they are not a part of the control measure.
<p>Checkpoint</p> <p>Predetermined point on the surface of the earth used as a means of controlling movement, a registration target for fire adjustment, or reference for location.</p> <p>Symbol Set Code: 25 Code: 130300</p>			<p>080700ZMAY08 - 120700ZMAY08</p> <p>VEHICLE</p> 
<p>Center of Main Effort</p> <p>Symbol Set Code: 25 Code: 130400</p>		<p><u>Anchor Points.</u> This symbol requires one anchor point. The center point defines the center of the symbol. <u>Size/Shape.</u> Static. <u>Orientation.</u> The symbol is typically centered over the desired location. Note: For the Center of Main effort, the symbol can be rotated so that the lines at the top of the</p>	
<p>Contact Point</p> <p>In land warfare, a point on the terrain, easily identifiable, where two or more units are required to make contact.</p> <p>Symbol Set Code: 25 Code: 130500</p>		<p>Note: For the Center of Main effort, the symbol can be rotated so that the lines at the top of the</p>	

TABLE H-VI. Command and Control points - Continued.

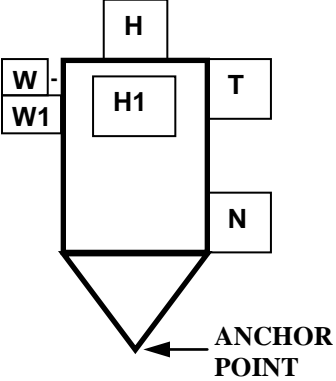
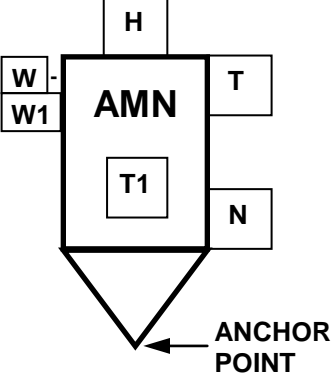
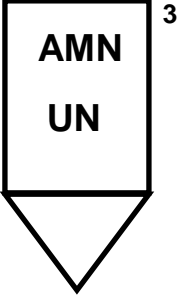

CONTROL MEASURE	TEMPLATE	DRAW RULES	EXAMPLE Note: The symbols that have been colored grey are used to help explain how the control measure is used, but they are not a part of the control measure.
<p>Coordinating Point</p> <p>Designated point at which, in all types of combat, adjacent units/formations must make contact for purposes of control and coordination.</p> <p>Symbol Set Code: 25 Code: 130600</p>		<p>symbol are oriented toward the point of main effort.</p> <p>Static/Dynamic: S</p>	
<p>Decision Point</p> <p>A point in space and time, identified during the planning process, where it is anticipated that the commander must make a decision concerning a specific course of action.</p> <p>Symbol Set Code: 25 Code: 130700</p>			
<p>Distress Call</p> <p>Symbol Set Code: 25 Code: 130800</p> <p>Static/Dynamic: S</p>		<p><u>Anchor Points.</u> This symbol requires one anchor point. The point defines the tip of the inverted cone. <u>Size/Shape.</u> Static.</p>	<p>141413ZNOV07 - 152014ZNOV07</p> 

TABLE H-VI. Command and Control points - Continued.

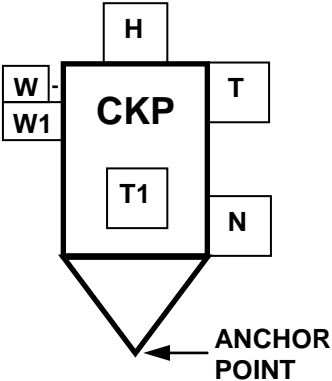
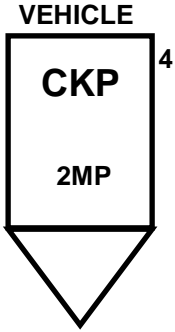
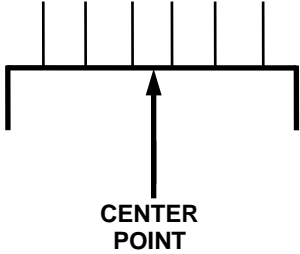
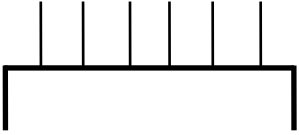
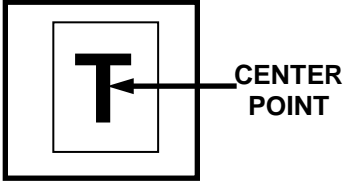
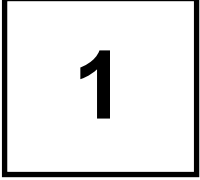
CONTROL MEASURE	TEMPLATE	DRAW RULES	EXAMPLE Note: The symbols that have been colored grey are used to help explain how the control measure is used, but they are not a part of the control measure.
<p>Entry Control Point</p> <p>Symbol Set Code: 25 Code: 130900</p>		<p><u>Orientation.</u> The symbol will typically be oriented upright, as shown in the example to the right.</p> <p>Static/Dynamic: S</p>	<p>PERSONNEL</p> <p>080700ZJUN08 - 110600ZJUN08</p> 
<p>Fly-To-Point</p> <p>Symbol Set Code: 25 Code: 131000</p>	<p>N/A</p>		<p>N/A</p>
<p>Fly-To-Point (Sonobuoy)</p> <p>Symbol Set Code: 25 Code: 131001</p>			<p>060900ZFEB08 - 100300ZFEB08</p> 
<p>Fly-To-Point (Weapon)</p> <p>Symbol Set Code: 25 Code: 131002</p>			<p>060900ZFEB08 - 100300ZFEB08</p> 

TABLE H-VI. Command and Control points - Continued.

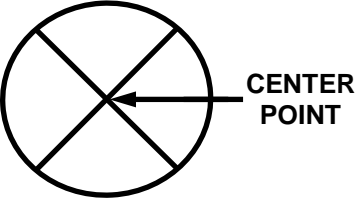
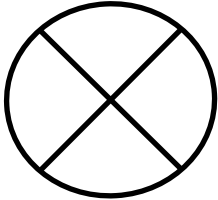
CONTROL MEASURE	TEMPLATE	DRAW RULES	EXAMPLE Note: The symbols that have been colored grey are used to help explain how the control measure is used, but they are not a part of the control measure.
<p>Fly-To-Point (Normal)</p> <p>Symbol Set Code: 25 Code: 131003</p>			<p>6</p> <p>060900ZFEB08 - 100300ZFEB08</p> 
<p>Linkup Point</p> <p>A point where two infiltrating elements in the same or different infiltration lanes are scheduled to meet to consolidate before proceeding with their missions.</p> <p>Symbol Set Code: 25 Code: 131100</p>			<p>NIGHT</p> <p>060900ZFEB08 - 100300ZFEB08</p> 
<p>Passage Point</p> <p>A specifically designated place where the passing units will pass through the stationary unit.</p> <p>Symbol Set Code: 25 Code: 131200</p>			<p>GOLD</p> <p>120700ZMAY08 - 120900ZMAY08</p> 

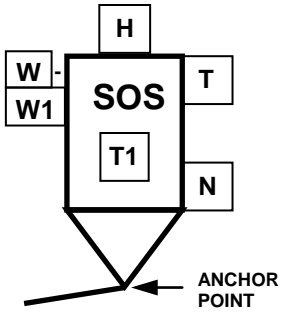
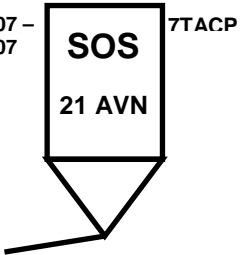
TABLE H-VI. Command and Control points - Continued.

CONTROL MEASURE	TEMPLATE	DRAW RULES	EXAMPLE Note: The symbols that have been colored grey are used to help explain how the control measure is used, but they are not a part of the control measure.
<p>Point of Interest</p> <p>Symbol Set Code: 25 Code: 131300</p>			
<p>Point of Interest – Launch Event</p> <p>Symbol Set Code: 25 Code: 131301</p>			
<p>Rally Point</p> <p>An easily identifiable point on the ground at which units can reassemble and reorganize if they become dispersed.</p> <p>Symbol Set Code: 25 Code: 131400</p>			<p>060900ZFEB08 - 100300ZFEB08</p> 

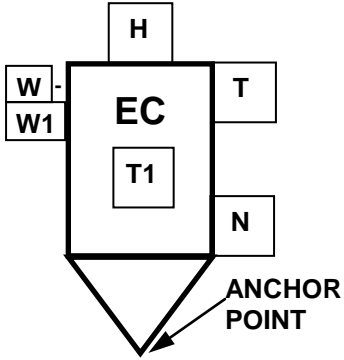
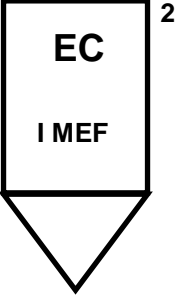
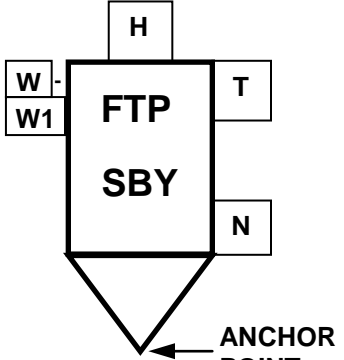
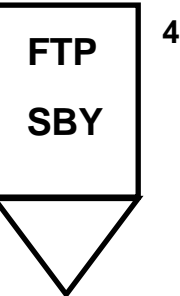
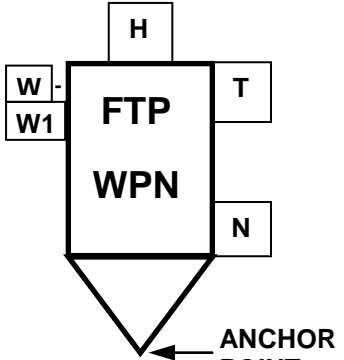
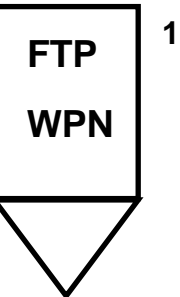
TABLE H-VI. Command and Control points - Continued.

CONTROL MEASURE	TEMPLATE	DRAW RULES	EXAMPLE Note: The symbols that have been colored grey are used to help explain how the control measure is used, but they are not a part of the control measure.
<p>Release Point</p> <p>In road movements, a well defined point on a route at which the elements composing a column return under the authority of their respective commanders, each one of these elements continuing its movement towards its own appropriate destination.</p> <p>Symbol Set Code: 25 Code: 131500</p>			<p>BDE</p> <p>060900ZFEB08 - 100300ZFEB08</p> 

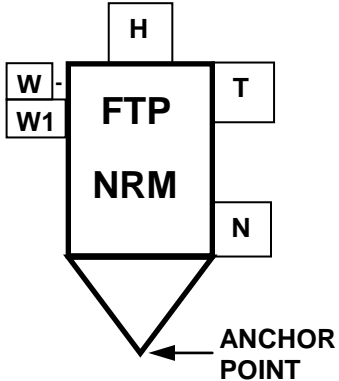
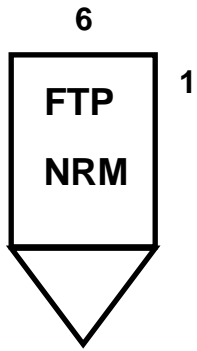
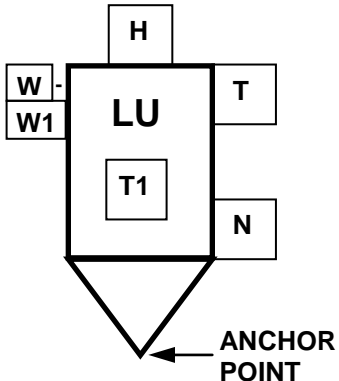
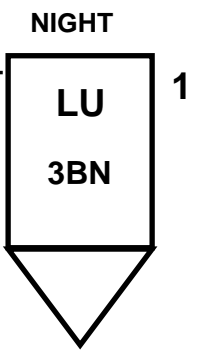
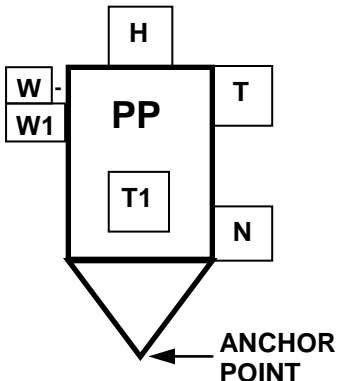
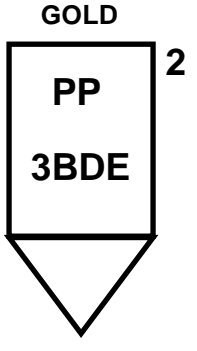
TABLE H-VI. Command and Control points - Continued.

CONTROL MEASURE	TEMPLATE	DRAW RULES	EXAMPLE Note: The symbols that have been colored grey are used to help explain how the control measure is used, but they are not a part of the control measure.
<p>Start Point</p> <p>A well defined point on a route at which a movement of vehicles begins to be under the control of the commander of this movement. It is at this point that the column is formed by the successive passing, at an appointed time, of each of the elements composing the column. In addition to the principal start point of a column there may be secondary start points for its different elements.</p> <p>Symbol Set Code: 25 Code: 131600</p>			
<p>Special Point</p> <p>Symbol Set Code: 25 Code: 131700</p>	<p>CENTER POINT</p> 	<p><u>Anchor Points.</u> This symbol requires one anchor point. The center point defines the center of the symbol. <u>Size/Shape.</u> Static. <u>Orientation.</u> The</p>	

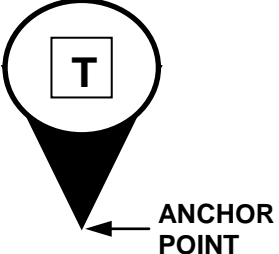
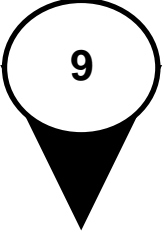
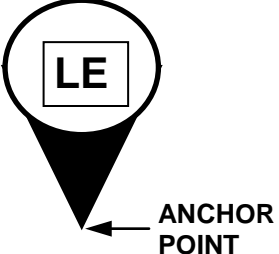
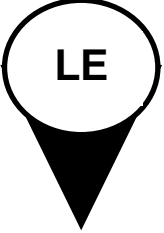
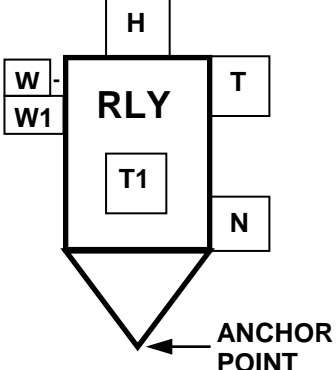
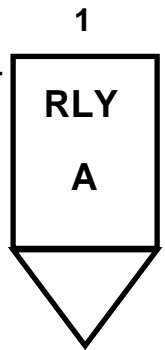
TABLE H-VI. Command and Control points - Continued.

CONTROL MEASURE	TEMPLATE	DRAW RULES	EXAMPLE Note: The symbols that have been colored grey are used to help explain how the control measure is used, but they are not a part of the control measure.
<p>Waypoint</p> <p>Designated point or series of points loaded and stored in a global positioning system or other electronic navigational aid system to facilitate movement.</p> <p>Symbol Set Code: 25 Code: 131800</p>	<p style="text-align: center;">CENTER POINT</p> 	<p>symbol is typically centered over the desired location.</p> <p>Static/Dynamic: S</p>	
<p>Airfield (AEGIS Only)</p> <p>Symbol Set Code: 25 Code: 131900</p>	<p style="text-align: center;">CENTER POINT</p> 		

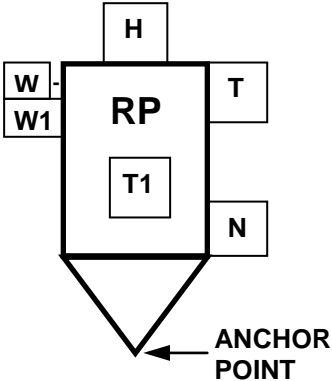
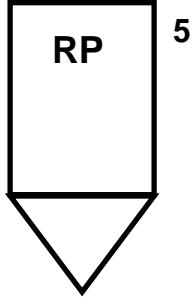
H.5.11 Maneuver Control Measure Symbols. Maneuver is the employment of forces on the battlefield through movement in combination with fire, or fire potential, to achieve a position of advantage in respect to the enemy in order to accomplish the mission.

TABLE H-VII. Maneuver control measure symbols.

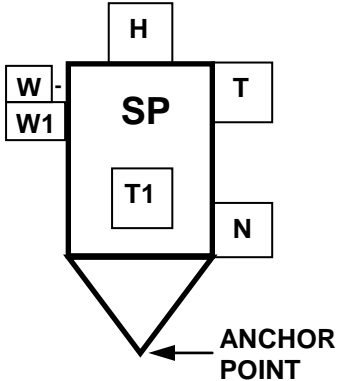
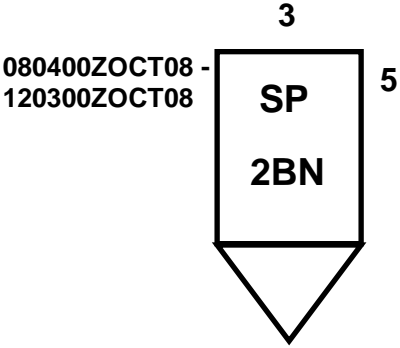
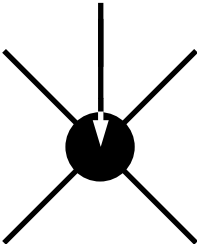
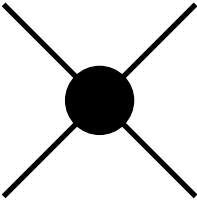
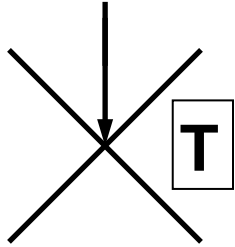
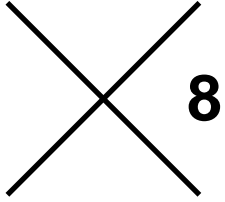
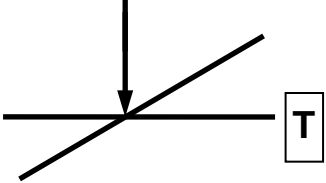
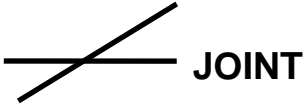
CONTROL MEASURE	TEMPLATE	DRAW RULES	EXAMPLE Note: The symbols that have been colored grey are used to help explain how the control measure is used, but they are not a part of the control measure.
Maneuver Lines Symbol Set Code: 25 Code: 140000	N/A		N/A
Forward Line of Troops A line which indicates the most forward positions of forces in any kind of military operation at a specific time. Symbol Set Code: 25 Code: 140100	N/A		N/A
Friendly Present Symbol Set Code: 25 Code: 140101		<u>Anchor Points</u> . This symbol requires at least two points, points 1 and 2, to define the line. Additional points can be defined to extend the line. <u>Size/Shape</u> . The first and last	

TABLE H-VII. Maneuver control measure symbols - Continued.

CONTROL MEASURE	TEMPLATE	DRAW RULES	EXAMPLE Note: The symbols that have been colored grey are used to help explain how the control measure is used, but they are not a part of the control measure.
<p>Friendly Planned or On Order</p> <p>Symbol Set Code: 25 Code: 140102</p>		<p>anchor points determine the length of the line.</p> <p><u>Orientation.</u> Orientation is determined by the order in which the anchor points are entered.</p> <p>Note: The open side of the arc reflects the reported unit.</p>	
<p>Enemy Known</p> <p>Symbol Set Code: 25 Code: 140103</p>		<p>Static/Dynamic: D</p>	

TABLE H-VII. Maneuver control measure symbols - Continued.

CONTROL MEASURE	TEMPLATE	DRAW RULES	EXAMPLE Note: The symbols that have been colored grey are used to help explain how the control measure is used, but they are not a part of the control measure.
<p>Enemy Suspected or Templated</p> <p>Symbol Set Code: 25 Code: 140104</p>			
<p>Line of Contact</p> <p>A general trace delineating the locations where two opposing forces are engaged.</p> <p>Symbol Set Code: 25 Code: 140200</p>	<p>The line of contact symbol is created when both the friendly and enemy forward line of troops symbols are displayed.</p>		

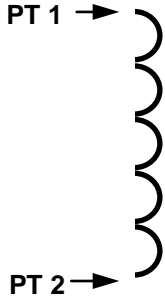
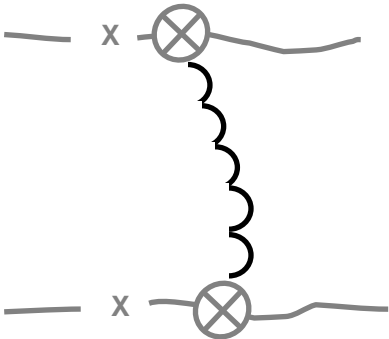
TABLE H-VII. Maneuver control measure symbols - Continued.

CONTROL MEASURE	TEMPLATE	DRAW RULES	EXAMPLE Note: The symbols that have been colored grey are used to help explain how the control measure is used, but they are not a part of the control measure.
<p>Phase Line</p> <p>A line utilized for control and coordination of military operations, usually a terrain feature extending across the zone of action.</p> <p>Symbol Set Code: 25 Code: 140300</p>		<p><u>Anchor Points.</u> This symbol requires at least two points, points 1 and 2, to define the line. Additional points can be defined to extend the line.</p> <p><u>Size/Shape.</u> The first and last anchor points determine the length of the line. The end-of line information will typically be posted at the ends of the line as it is displayed on the screen.</p> <p><u>Orientation.</u> Orientation is determined by the order in which the anchor points are entered.</p> <p>Static/Dynamic: D</p>	
<p>Forward Edge of the Battle Area</p> <p>The foremost limits of a series of areas in which ground combat units are deployed, excluding the areas in which the covering or screening forces are operating, designated to coordinate fire support, the positioning of forces or the maneuver of units.</p> <p>Symbol Set Code: 25 Code: 140400</p>		<p>Static/Dynamic: D</p>	
<p>Proposed or On Order Forward Edge of the Battle Area</p> <p>Symbol Set Code: 25 Code: 140401</p>			

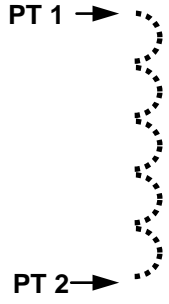
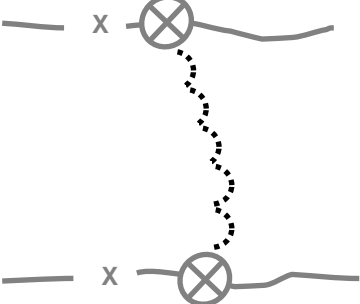
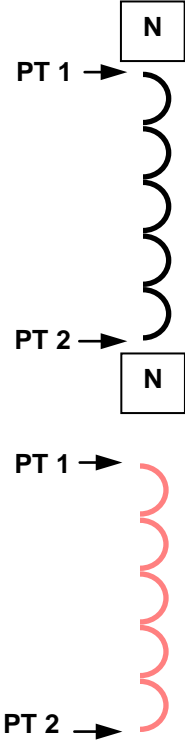
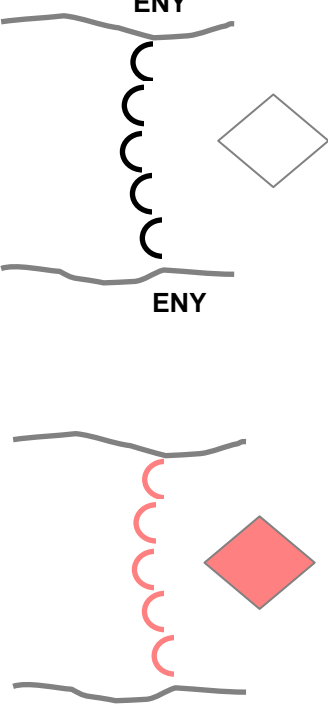
TABLE H-VII. Maneuver control measure symbols - Continued.

CONTROL MEASURE	TEMPLATE	DRAW RULES	EXAMPLE Note: The symbols that have been colored grey are used to help explain how the control measure is used, but they are not a part of the control measure.
<p>Principal Direction of Fire</p> <p>Symbol Set Code: 25 Code: 140500</p>		<p><u>Anchor Points.</u> This symbol requires three anchor points. Point 1 defines the vertex of the symbol. Points 2 and 3 define the tips of the arrowheads.</p> <p><u>Size/Shape.</u> The length and orientation of the arrows can vary independently.</p> <p><u>Orientation.</u> Orientation is determined by the anchor points. The arrowheads may touch other symbols that define the limits of the task. The top of the tactical symbol indicator may touch point 1.</p>	
<i>Areas</i>			
<p>Maneuver Areas</p> <p>Symbol Set Code: 25 Code: 150000</p>	N/A		N/A
<p>Area</p> <p>Symbol Set Code: 25 Code: 150100</p>	N/A		N/A
<p>Friendly Area</p> <p>Symbol Set Code: 25 Code: 150101</p>		<p><u>Anchor Points.</u> This symbol requires at least three anchor points to define the boundary of the area. Add as</p>	

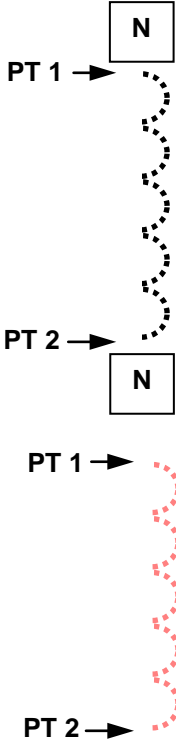
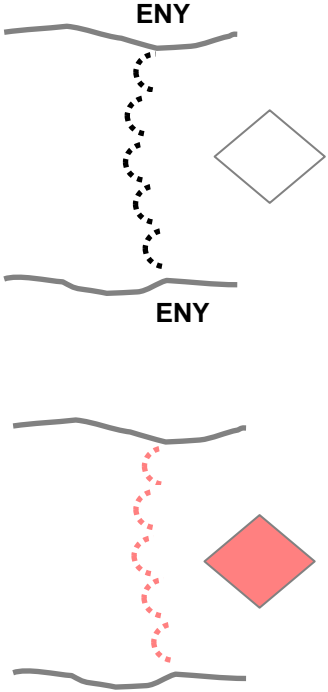
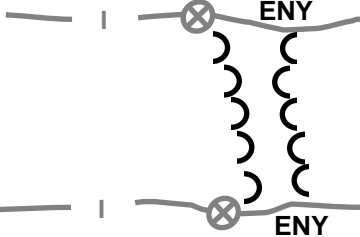
TABLE H-VII. Maneuver control measure symbols - Continued.



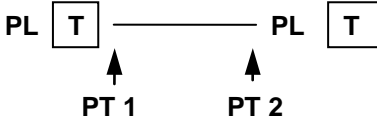
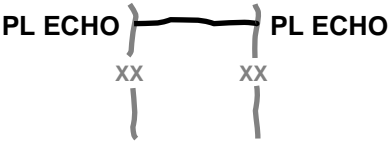
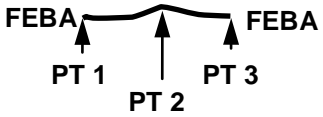
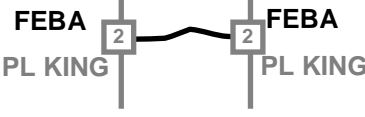
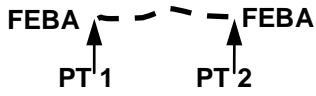
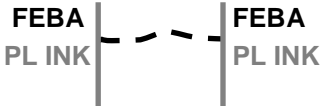

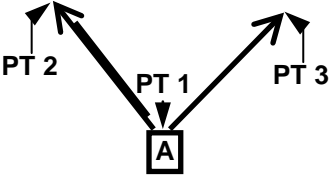
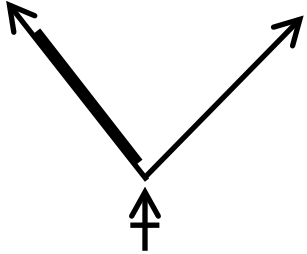
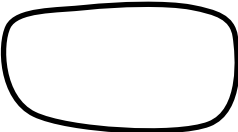
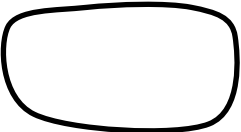

CONTROL MEASURE	TEMPLATE	DRAW RULES	EXAMPLE Note: The symbols that have been colored grey are used to help explain how the control measure is used, but they are not a part of the control measure.
Friendly Planned or On Order Area Symbol Set Code: 25 Code: 150102		many points as necessary to accurately reflect the area's size and shape. <u>Size/Shape</u> . Determined by the anchor points. The information field should be moveable within the area. <u>Orientation</u> . Not applicable.	
Enemy Known or Confirmed Area Symbol Set Code: 25 Code: 150103		Static/Dynamic: D	 
Enemy Suspected Area Symbol Set Code: 25 Code: 150104			 
Assembly Area (AA) An area in which a command is assembled preparatory to further action. Symbol Set Code: 25 Code: 150200			

TABLE H-VII. Maneuver control measure symbols - Continued.

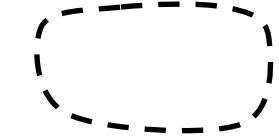
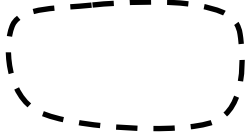
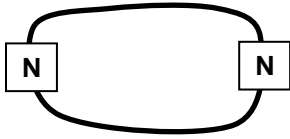
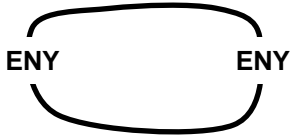
CONTROL MEASURE	TEMPLATE	DRAW RULES	EXAMPLE Note: The symbols that have been colored grey are used to help explain how the control measure is used, but they are not a part of the control measure.
Occupied Assembly Area Symbol Set Code: 25 Code: 150300		<u>Anchor Points.</u> This symbol requires at least three anchor points to define the boundary of the area. Add as many points as necessary to accurately reflect the area's size and shape.	
Occupied Assembly Area with Offset Unit Symbol Set Code: 25 Code: 150301		accurately reflect the area's size and shape.	
Occupied Assembly Area with Offset Units Symbol Set Code: 25 Code: 150302		The information field should be moveable within the area.	
Proposed or On Order Assembly Area Symbol Set Code: 25 Code: 150400		Note: Although unit symbols are not part of this control measure symbol area, numerous unit symbols can be included in the area for presentation. Static/Dynamic: D	
Action Area Symbol Set Code: 25 Code: 150500	N/A		N/A

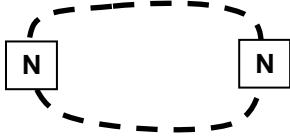
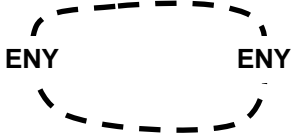
TABLE H-VII. Maneuver control measure symbols - Continued.

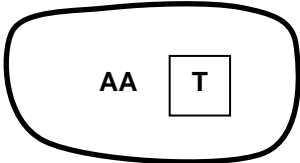



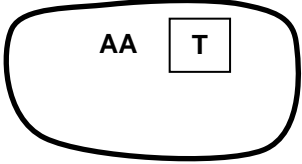
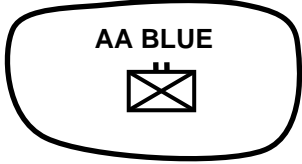
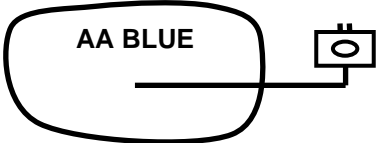
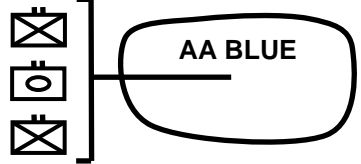
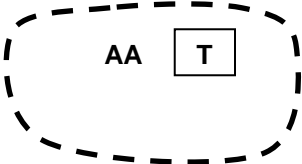
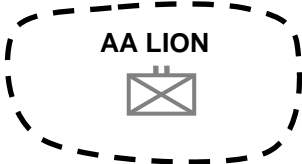

CONTROL MEASURE	TEMPLATE	DRAW RULES	EXAMPLE Note: The symbols that have been colored grey are used to help explain how the control measure is used, but they are not a part of the control measure.
<p>Joint Tactical Action Area (JTAA)</p> <p>Symbol Set Code: 25 Code: 150501</p>		<p><u>Anchor Points.</u> This symbol requires at least three anchor points to define the boundary of the area. Add as many points as necessary to accurately reflect the area's size and shape.</p> <p><u>Size/Shape.</u> Determined by the anchor points. The information field should be moveable within the area.</p> <p><u>Orientation.</u> Not applicable.</p>	
<p>Submarine Action Area (SAA)</p> <p>Symbol Set Code: 25 Code: 150502</p>			
<p>Submarine-Generated Action Area (SGAA)</p> <p>Symbol Set Code: 25 Code: 150503</p>			
<p>Drop Zone (DZ)</p> <p>A specified area upon which airborne troops, equipment, or supplies are airdropped.</p> <p>Symbol Set Code: 25 Code: 150600</p>		<p>Static/Dynamic: D</p>	

TABLE H-VII. Maneuver control measure symbols - Continued.

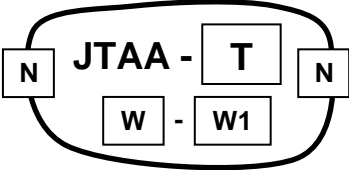
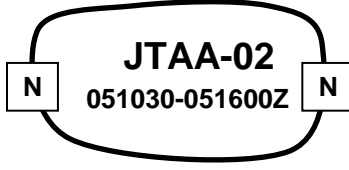
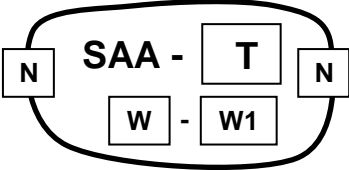

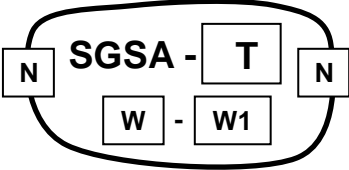

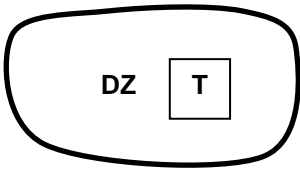

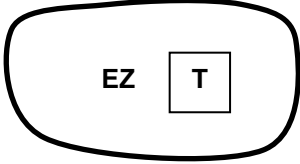

CONTROL MEASURE	TEMPLATE	DRAW RULES	EXAMPLE Note: The symbols that have been colored grey are used to help explain how the control measure is used, but they are not a part of the control measure.
<p>Extraction Zone (EZ)</p> <p>A specified drop zone used for the delivery of supplies and/or equipment by means of an extraction technique from an aircraft flying very close to the ground.</p> <p>Symbol Set Code: 25 Code: 150700</p>			
<p>Landing Zone (LZ)</p> <p>A specified zone used for the landing of aircraft on land, water or deck.</p> <p>Symbol Set Code: 25 Code: 150800</p>			
<p>Pickup Zone (PZ)</p> <p>A geographic area used to pick up troops or equipment by helicopter.</p> <p>Symbol Set Code: 25 Code: 150900</p>			

TABLE H-VII. Maneuver control measure symbols - Continued.

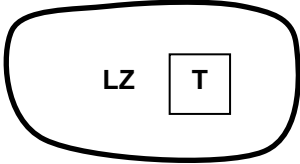
CONTROL MEASURE	TEMPLATE	DRAW RULES	EXAMPLE Note: The symbols that have been colored grey are used to help explain how the control measure is used, but they are not a part of the control measure.
<p>Fortified Area.</p> <p>Symbol Set Code: 25 Code: 151000</p>			
<p>Limited Access Area</p> <p>Symbol Set Code: 25 Code: 151100</p> <p>Static/Dynamic: D</p>		<p><u>Anchor Points.</u> The area symbol requires at least three anchor points to define the boundary of the area. Add as many points as necessary to accurately reflect the area's size and shape. The LAA point symbol requires one anchor point and is connected to the area symbol with a straight line.</p> <p><u>Size/Shape.</u> Determined by the anchor points. The information field should be moveable within the area.</p> <p><u>Orientation.</u> The LAA point symbol will be oriented upright, as shown in the example to the right.</p>	

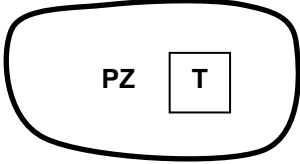
H.5.12 Defensive maneuver. Defensive operations defeat an enemy attack, buy time, economize forces, or develop conditions favorable for offensive operations.

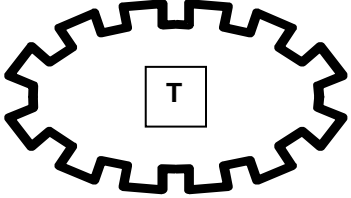
H.5.12.1 Areas.

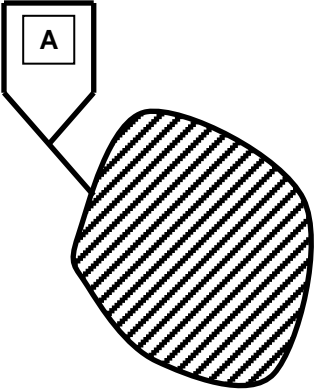
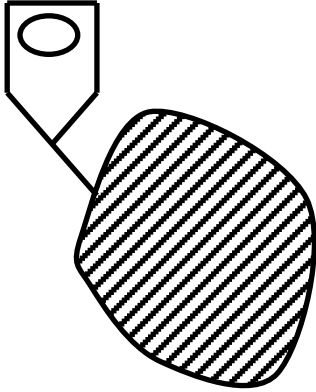
TABLE H-VIII. Defensive control measure symbols.

CONTROL MEASURE	TEMPLATE	DRAW RULES	EXAMPLE Note: The symbols that have been colored grey are used to help explain how the control measure is used, but they are not a part of the control measure.
<p>Battle Position</p> <p>A defensive location oriented on a likely enemy avenue of approach.</p> <p>Symbol Set Code: 25 Code: 151200</p>		<p><u>Anchor Points</u>. This symbol requires at least three anchor points to define the boundary of the area. Add as many points as necessary to accurately reflect the area's size and shape.</p>	
<p>Battle Position Planned</p> <p>Symbol Set Code: 25 Code: 151201</p>		<p><u>Size/Shape</u>. Determined by the anchor points. The information field should be moveable and scalable within the area.</p> <p><u>Orientation</u>. The side opposite Field B (Echelon) faces toward the hostile force.</p>	
<p>Battle Position Prepared (P) but not Occupied</p> <p>Symbol Set Code: 25 Code: 151202</p>		<p>Static/Dynamic: D</p>	

TABLE H-VIII. Defensive control measure symbols – Continued.

CONTROL MEASURE	TEMPLATE	DRAW RULES	EXAMPLE Note: The symbols that have been colored grey are used to help explain how the control measure is used, but they are not a part of the control measure.
<p>Strong Point</p> <p>A key point in a defensive position usually strongly fortified and heavily armed with automatic weapons, around which other positions are grouped for its protection.</p> <p>Symbol Set Code: 25 Code: 151203</p> <p>Static/Dynamic: D</p>		<p><u>Anchor Points.</u> This symbol requires at least three anchor points to define the boundary of the area. Add as many points as necessary to accurately reflect the area's size and shape.</p> <p><u>Size/Shape.</u> Determined by the anchor points. The information field should be moveable within the area. The default tic length should be the same as the text height of the echelon field (B). Spacing between the tics should also be the height of B. Users should be provided a facility to allow them to manually alter the height of B, which in turn should affect the tic length and spacing accordingly.</p> <p><u>Orientation.</u> Not applicable.</p>	

TABLE H-VIII. Defensive control measure symbols – Continued.

CONTROL MEASURE	TEMPLATE	DRAW RULES	EXAMPLE Note: The symbols that have been colored grey are used to help explain how the control measure is used, but they are not a part of the control measure.
<p>Contain</p> <p>Symbol Set Code: 25 Code: 151204</p> <p>Static/Dynamic: D</p>		<p><u>Anchor Points.</u> This symbol requires three anchor points. Points 1 and 2 define the endpoints of the semicircle's opening. Point 3 defines the end of the arrow.</p> <p><u>Size/Shape.</u> Points 1 and 2 determine the diameter of the semicircle and point 3 determines the length of the arrow. The tip of the arrowhead will be at the center point of the semicircle's diameter and will project perpendicularly from the line between points 1 and 2. The default tic length should be the same as the text height of the echelon field (B). Spacing between the tics should also be the height of B. Users should be provided a facility to allow them to manually alter the height of B, which in turn should affect the tic length and spacing accordingly.</p> <p><u>Orientation.</u> The opening typically faces enemy forces.</p>	

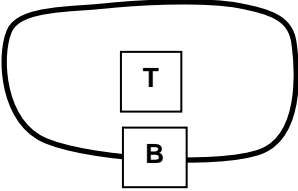
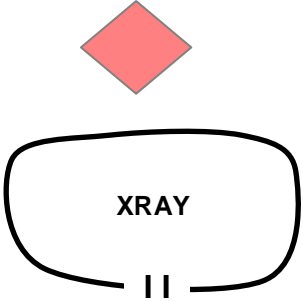
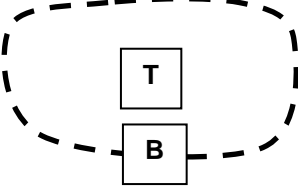
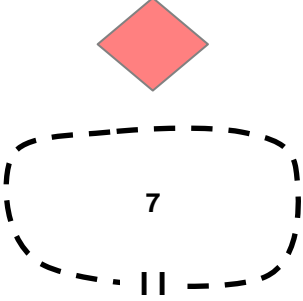
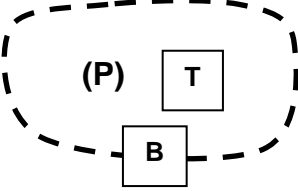
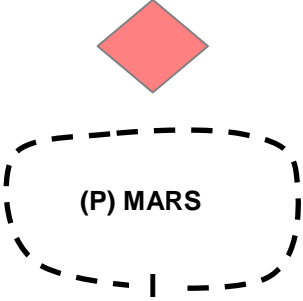
TABLE H-VIII. Defensive control measure symbols – Continued.

CONTROL MEASURE	TEMPLATE	DRAW RULES	EXAMPLE Note: The symbols that have been colored grey are used to help explain how the control measure is used, but they are not a part of the control measure.
<p>Retain</p> <p>Symbol Set Code: 25 Code: 151205</p> <p>Static/Dynamic: D</p>		<p><u>Anchor Points.</u> This symbol requires two anchor points. Point 1 defines the center point of the graphic and point 2 defines the graphic's start point and radius. <u>Size/Shape.</u> Points 1 and 2 will determine a radius that is long enough for the graphic to encompass the feature(s) being retained. The opening will be a 30-degree arc of the circle. The default tic length should be the same as the text height of the echelon field (R). Spacing between the tics should also be the height of R. Users should be provided a facility to allow them to manually alter the height of R, which in turn should affect the tic length and spacing accordingly. <u>Orientation.</u> The opening will be on the friendly side of the symbol.</p>	

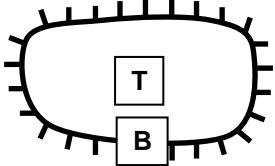
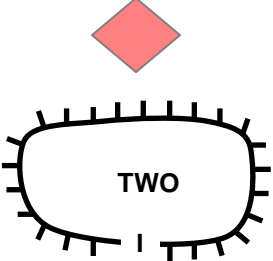
TABLE H-VIII. Defensive control measure symbols – Continued.

CONTROL MEASURE	TEMPLATE	DRAW RULES	EXAMPLE Note: The symbols that have been colored grey are used to help explain how the control measure is used, but they are not a part of the control measure.
<p>Engagement Area (EA)</p> <p>An area where the commander intends to contain and destroy an enemy force with the massed effects of all available weapons and supporting systems.</p> <p>Symbol Set Code: 25 Code: 151300</p> <p>Static/Dynamic: D</p>		<p><u>Anchor Points.</u> This symbol requires at least three anchor points to define the boundary of the area. Add as many points as necessary to accurately reflect the area's size and shape.</p> <p><u>Size/Shape.</u> Determined by the anchor points. The information field should be moveable as a block within the area.</p> <p><u>Orientation.</u> Not applicable.</p>	

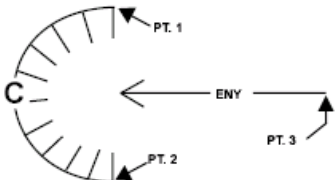
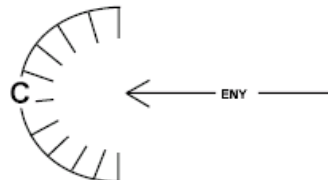
H.5.12.2 Observation post. A position from which military observations are made, or fire directed and adjusted and which possesses appropriate communications; may be airborne.

TABLE H-IX. Observation post.

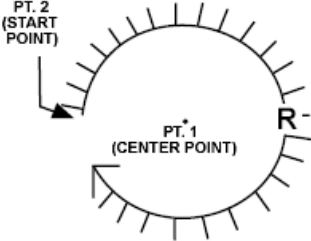
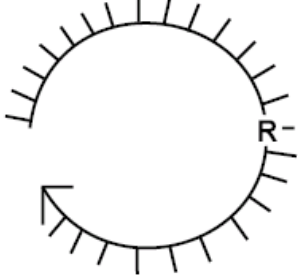
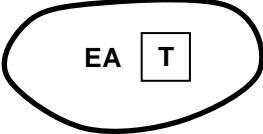
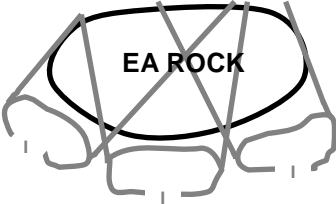
CONTROL MEASURE	TEMPLATE	DRAW RULES	EXAMPLE Note: The symbols that have been colored grey are used to help explain how the control measure is used, but they are not a part of the control measure.
Maneuver Points Symbol Set Code: 25 Code: 160000	N/A		N/A
Observation Post /Outpost (Unspecified) Symbol Set Code: 25 Code: 160100		<u>Anchor Points</u> . This symbol requires one anchor point. The center point defines the center of the symbol.	
Observation Post /Outpost (Specified) Symbol Set Code: 25 Code: 160200		<u>Size/Shape</u> . Static. <u>Orientation</u> . The symbol is typically centered over the desired location.	Examples follow.
Reconnaissance Outpost Symbol Set Code: 25 Code: 160201		Static/ Dynamic: S	
Forward Observer Outpost/Position Symbol Set Code: 25 Code: 160202			
CBRN Observation Outpost Symbol Set Code: 25 Code: 160203			

TABLE H-IX. Observation post - Continued.



CONTROL MEASURE	TEMPLATE	DRAW RULES	EXAMPLE Note: The symbols that have been colored grey are used to help explain how the control measure is used, but they are not a part of the control measure.
Sensor Outpost/Listening Post Symbol Set Code: 25 Code: 160204			
Combat Outpost Symbol Set Code: 25 Code: 160205			

TABLE H-IX. Observation post - Continued.

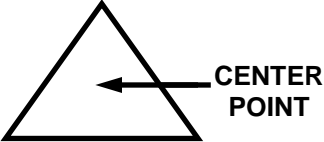
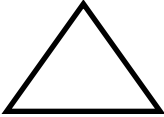
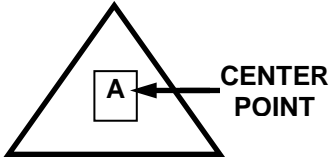
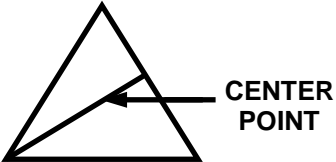
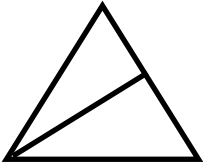
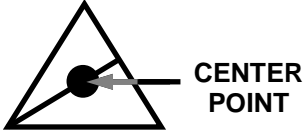
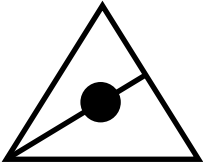
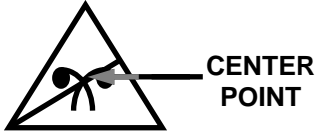
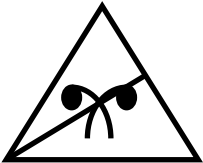
CONTROL MEASURE	TEMPLATE	DRAW RULES	EXAMPLE Note: The symbols that have been colored grey are used to help explain how the control measure is used, but they are not a part of the control measure.
<p>Target Reference Point</p> <p>An easily recognizable point on the ground (either natural or manmade) used to initiate, distribute and control fires. Target reference points (TRPs) can also designate the center of an area where the commander plans to distribute or converge the fires of all his weapons rapidly. They are used by task force and below and can further delineate sectors of fire within an engagement area. TRPs are designated using the standard target symbol and numbers issued by the fire support officer. Once designated, TRPs also constitute indirect fire targets.</p> <p>Symbol Set Code: 25 Code: 160300</p>			

H.5.13 Offensive maneuver. Offensive operations aim at destroying or defeating an enemy.

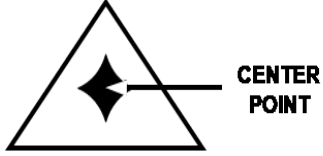
H.5.13.1 Axis of advance. A line of advance assigned for purposes of control; often a road or a group of roads, or a designated series of locations, extending in the direction of the enemy.

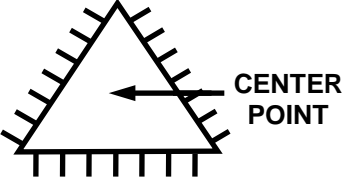
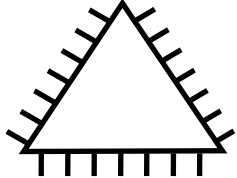
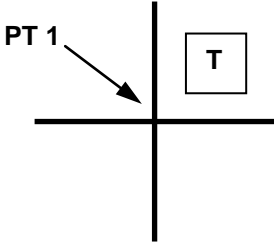
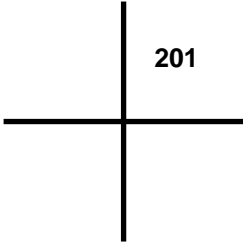
TABLE H-X. Offensive Control Measure Symbols.

CONTROL MEASURE	TEMPLATE	DRAW RULES	EXAMPLE Note: The symbols that have been colored grey are used to help explain how the control measure is used, but they are not a part of the control measure.
<p>Axis of Advance</p> <p>Symbol Set Code: 25 Code: 151400</p>	<p>N/A</p>		<p>N/A</p>
<p>Friendly Airborne/Aviation</p> <p>Symbol Set Code: 25 Code: 151401</p>		<p><u>Anchor Points.</u> The symbol requires N anchor points, where N is between 3 and 50. Point 1 defines the tip of the arrowhead. Point N-1 defines the rear of the symbol. Point N defines the back of the arrowhead. Anchor points are numbered sequentially beginning with point number one (1), in increments of one (1).</p> <p><u>Size/Shape.</u> Points 1 through N-1 and 2 determine the graphic's centerline and</p>	<p>Airborne</p>  <p>Aviation</p> 

TABLE H-X. Offensive Control Measure Symbols - Continued.

CONTROL MEASURE	TEMPLATE	DRAW RULES	EXAMPLE Note: The symbols that have been colored grey are used to help explain how the control measure is used, but they are not a part of the control measure.
<p>Attack Helicopter</p> <p>Symbol Set Code: 25 Code: 151402</p>		<p>Point N determines the width. The crossover point on the symbol shall occur between Points 1 and 2.</p> <p><u>Orientation.</u> The arrowhead typically points toward enemy forces.</p> <p>Static/Dynamic: D</p>	
<p>Main Attack</p> <p>The principal attack or effort into which the commander throws the full weight of the offensive power at his disposal.</p> <p>Symbol Set Code: 25 Code: 151403</p>		<p><u>Anchor Points.</u> The symbol requires N anchor points, where N is between 3 and 50. Point 1 defines the tip of the arrowhead. Point N-1 defines the rear of the symbol. Point N defines the back of the</p>	

TABLE H-X. Offensive Control Measure Symbols - Continued.

CONTROL MEASURE	TEMPLATE	DRAW RULES	EXAMPLE Note: The symbols that have been colored grey are used to help explain how the control measure is used, but they are not a part of the control measure.
<p>Supporting Attack</p> <p>An offensive operation carried out in conjunction with a main attack and designed to achieve one or more of the following:</p> <ol style="list-style-type: none"> deceive the enemy; destroy or pin down enemy forces which could interfere with the main attack; control ground whose occupation by the enemy will hinder the main attack; or force the enemy to commit reserves prematurely or in an indecisive area. <p>Symbol Set Code: 25 Code: 151404</p>		<p>arrowhead. Anchor points are numbered sequentially beginning with point number one (1), in increments of one (1). <u>Size/Shape.</u> Points 1 through N-1 and 2 determine the symbol's centerline and Point N determines the width. <u>Orientation.</u> The arrowhead typically points toward enemy forces.</p> <p>Static/Dynamic: D</p>	

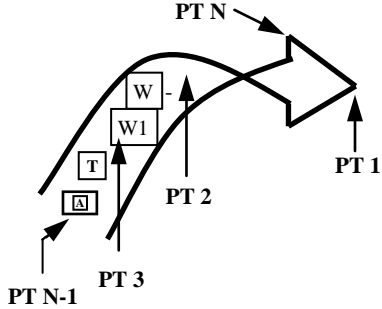
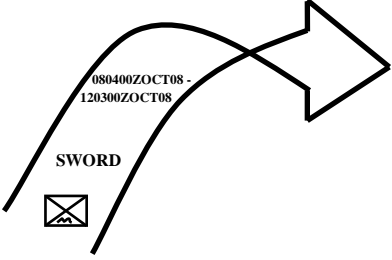
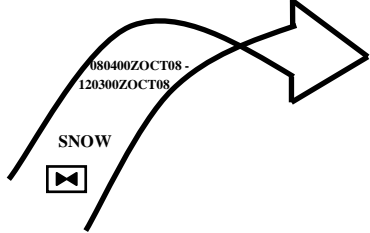
TABLE H-X. Offensive Control Measure Symbols - Continued.

CONTROL MEASURE	TEMPLATE	DRAW RULES	EXAMPLE Note: The symbols that have been colored grey are used to help explain how the control measure is used, but they are not a part of the control measure.
<p>Supporting Attack Planned or On Order</p> <p>Symbol Set Code: 25 Code: 151405</p>			
<p>Axis of Advance for a Feint</p> <p>Symbol Set Code: 25 Code: 151406</p>			
<p>Enemy Confirmed</p> <p>Symbol Set Code: 25 Code: 151407</p>			

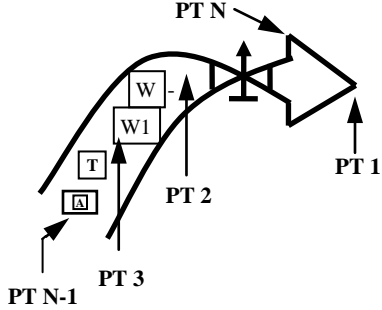
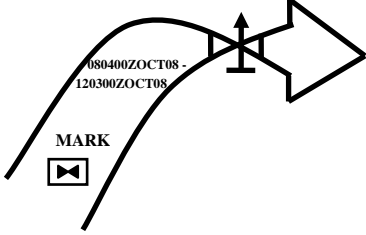
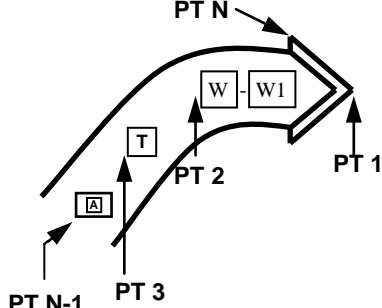
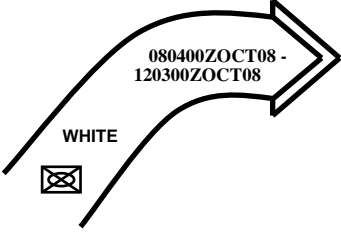
TABLE H-X. Offensive Control Measure Symbols - Continued.

CONTROL MEASURE	TEMPLATE	DRAW RULES	EXAMPLE Note: The symbols that have been colored grey are used to help explain how the control measure is used, but they are not a part of the control measure.
<p>Enemy Templated or Suspected</p> <p>Symbol Set Code: 25 Code: 151408</p>			

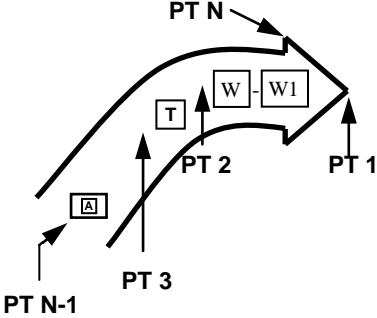
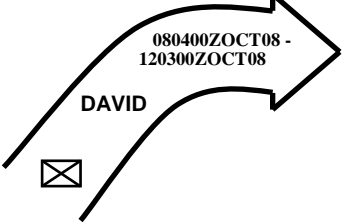
H.5.13.2 Direction of attack. A specific direction or route that the main attack or center of mass of the unit will follow.

TABLE H-XI. Direction of attack.

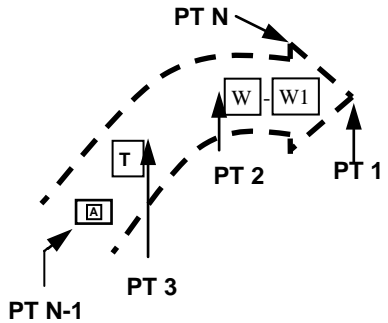
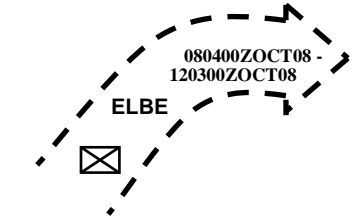
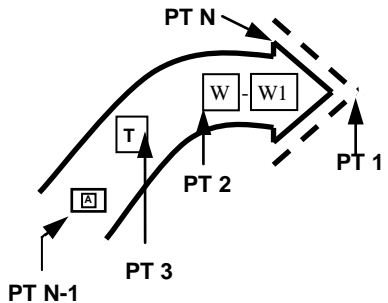
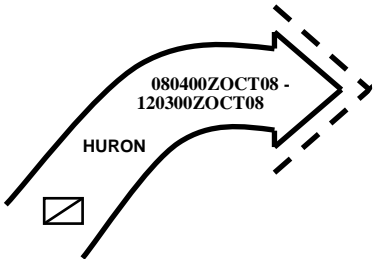
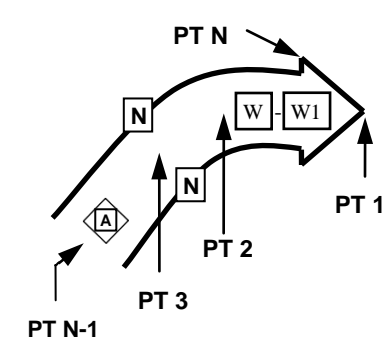
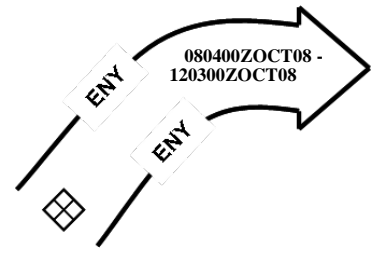
CONTROL MEASURE	TEMPLATE	DRAW RULES	EXAMPLE Note: The symbols that have been colored grey are used to help explain how the control measure is used, but they are not a part of the control measure.
<p>Direction of Attack</p> <p>Symbol Set Code: 25 Code: 140600</p>	<p>N/A</p>		<p>N/A</p>
<p>Friendly Aviation</p> <p>Symbol Set Code: 25 Code: 140601</p>		<p><u>Anchor Points.</u> This symbol requires at least two points, points 1 and 2, to define the line. Additional points can be defined to extend the line. <u>Size/Shape.</u> The first and last anchor points</p>	

TABLE H-XI. Direction of attack - Continued.

CONTROL MEASURE	TEMPLATE	DRAW RULES	EXAMPLE Note: The symbols that have been colored grey are used to help explain how the control measure is used, but they are not a part of the control measure.
<p>Friendly Direction of Main Attack</p> <p>Symbol Set Code: 25 Code: 140602</p>		<p>determine the length of the line. <u>Orientation.</u> Orientation is determined by the anchor points.</p>	
<p>Friendly Direction of Supporting Attack</p> <p>Symbol Set Code: 25 Code: 140603</p>		<p>Static/Dynamic: D</p>	
<p>Friendly Ground Axis Planned or On Order with Effective Date and Time (if known)</p> <p>Symbol Set Code: 25 Code: 140604</p>			
<p>Direction of Attack for a Feint</p> <p>Symbol Set Code: 25 Code: 140605</p>			
<p>Enemy Confirmed</p> <p>Symbol Set Code: 25 Code: 140606</p>			
<p>Enemy Templated or Suspected</p> <p>Symbol Set Code: 25 Code: 140607</p>			

TABLE H-XI. Direction of attack - Continued.

CONTROL MEASURE	TEMPLATE	DRAW RULES	EXAMPLE Note: The symbols that have been colored grey are used to help explain how the control measure is used, but they are not a part of the control measure.
<i>Lines</i>			
<p>Final Coordination Line</p> <p>A line close to the enemy position used to coordinate the lifting or shifting of supporting fires with the final deployment of maneuver elements.</p> <p>Symbol Set Code: 25 Code: 140700</p> <p>Static/Dynamic: D</p>		<p><u>Anchor Points.</u> This symbol requires at least two points, points 1 and 2, to define the line. Additional points can be defined to extend the line.</p> <p><u>Size/Shape.</u> The first and last anchor points determine the length of the line. The end-of line information will typically be posted at the ends of the line as it is displayed on the screen.</p> <p><u>Orientation.</u> Orientation is determined by the order in which the anchor points are entered.</p>	

TABLE H-XI. Direction of attack - Continued.

CONTROL MEASURE	TEMPLATE	DRAW RULES	EXAMPLE Note: The symbols that have been colored grey are used to help explain how the control measure is used, but they are not a part of the control measure.
<p>Infiltration Lane</p> <p>A control measure that coordinates forward and lateral movement of infiltrating units and fixes fire planning responsibilities.</p> <p>Symbol Set Code: 25 Code: 140800</p> <p>Static/Dynamic: D</p>		<p><u>Anchor Points.</u> This symbol requires three anchor points. Points 1 and 2 define the endpoints of the infiltration lane and point 3 defines one side of the lane.</p> <p><u>Size/Shape.</u> Points 1 and 2 determine the centerline of the symbol and point 3 determines the width of the infiltration lane. The rest of the symbol stays proportional to the length of the centerline.</p> <p><u>Orientation.</u> Orientation is determined by points 1 and 2.</p>	
<p>Limit of Advance</p> <p>An easily recognized terrain feature beyond which attacking elements will not advance.</p> <p>Symbol Set Code: 25 Code: 140900</p>		<p><u>Anchor Points.</u> This symbol requires at least two points, points 1 and 2, to define the line. Additional points can be defined to extend the line.</p> <p><u>Size/Shape.</u> The first and last anchor points determine the length of the line. The end-of</p>	

TABLE H-XI. Direction of attack - Continued.

CONTROL MEASURE	TEMPLATE	DRAW RULES	EXAMPLE Note: The symbols that have been colored grey are used to help explain how the control measure is used, but they are not a part of the control measure.
<p>Line of Departure</p> <p>In land warfare, a line designated to coordinate the departure of attack elements. In amphibious warfare, a suitably marked offshore coordinating line to assist assault craft to land on designated beaches at scheduled times.</p> <p>Symbol Set Code: 25 Code: 141000</p>		<p>line information will typically be posted at the ends of the line as it is displayed on the screen.</p> <p><u>Orientation.</u> Orientation is determined by the order in which the anchor points are entered.</p> <p>Static/Dynamic: D</p>	
<p>Line of Departure / Line of Contact</p> <p>The designation of forward friendly positions as the line of departure when opposing forces are in contact.</p> <p>Symbol Set Code: 25 Code: 141100</p>			

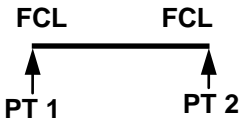
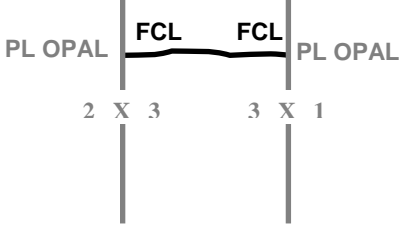
TABLE H-XI. Direction of attack - Continued.

CONTROL MEASURE	TEMPLATE	DRAW RULES	EXAMPLE Note: The symbols that have been colored grey are used to help explain how the control measure is used, but they are not a part of the control measure.
<p>Probable Line of Deployment.</p> <p>A line selected on the ground, usually the last covered and concealed position prior to the objective and forward of the line of departure, where attacking units deploy prior to beginning an assault; it is generally used under conditions of limited visibility.</p> <p>Note: The dashed lines in this graphic shall be displayed in present and anticipated status.</p> <p>Symbol Set Code: 25 Code: 141200</p>			

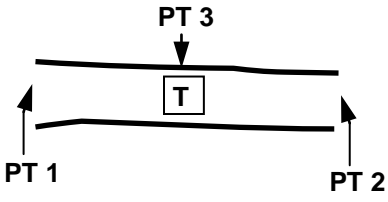
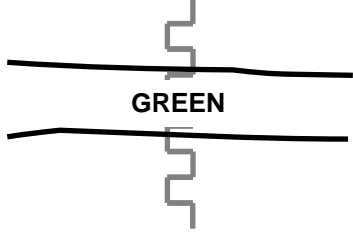
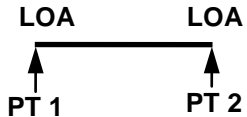
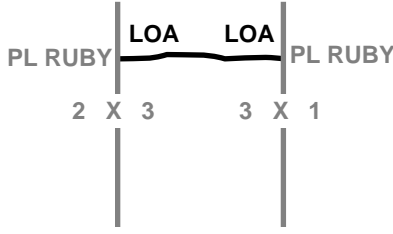
TABLE H-XI. Direction of attack - Continued.



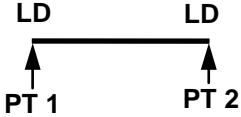
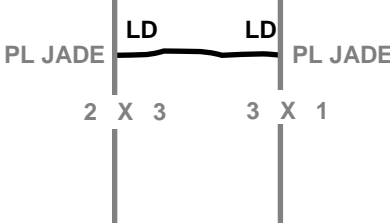
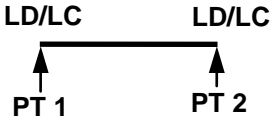
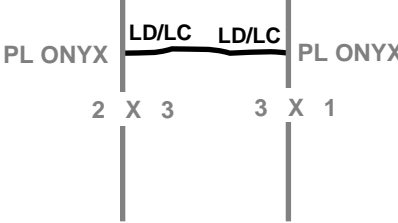

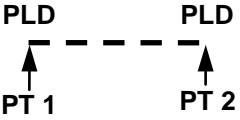
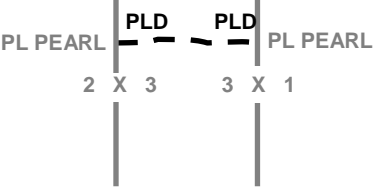

CONTROL MEASURE	TEMPLATE	DRAW RULES	EXAMPLE Note: The symbols that have been colored grey are used to help explain how the control measure is used, but they are not a part of the control measure.
<i>Areas</i>			
<p>Assault Position.</p> <p>That position between the line of departure and the objective in an attack from which forces assault the objective. Ideally, it is the last covered and concealed position before reaching the objective.</p> <p>Symbol Set Code: 25 Code: 151500</p>		<p><u>Anchor Points.</u> This symbol requires at least three anchor points to define the boundary of the area. Add as many points as necessary to accurately reflect the area's size and shape.</p> <p><u>Size/Shape.</u> Determined by the anchor points. The information field should be moveable and scalable as a block within the area.</p>	
<p>Attack Position</p> <p>The last position occupied by the assault echelon before crossing the start line/line of departure.</p> <p>Note: The 'A' modifier is used only if a unit must stop in the attack position. Offset indicator may also be used.</p> <p>Symbol Set Code: 25 Code: 151600</p>	 	<p><u>Orientation.</u> Not applicable.</p> <p>Static/Dynamic: D</p>	 

TABLE H-XI. Direction of attack - Continued.

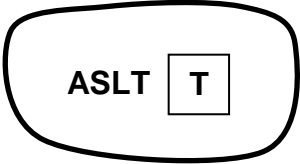
CONTROL MEASURE	TEMPLATE	DRAW RULES	EXAMPLE Note: The symbols that have been colored grey are used to help explain how the control measure is used, but they are not a part of the control measure.
<p>Objective Area</p> <p>A defined geographical area within which is located an objective to be captured or reached by the military forces. This area is defined by competent authority for purposes of command and control.</p> <p>Symbol Set Code: 25 Code: 151700</p>			
Points			
<p>Point of Departure</p> <p>A specific place where a unit will cross the line of departure.</p> <p>Symbol Set Code: 25 Code: 160400</p> <p>Static/Dynamic: S</p>		<p><u>Anchor Points.</u> This symbol requires one anchor point. The point defines the tip of the inverted cone. <u>Size/Shape.</u> Static. <u>Orientation.</u> The symbol will typically be oriented upright.</p>	 <p>Note: The offset indicator is used in the example to allow the viewer to better see the LD. It is not required</p>

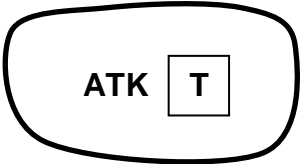
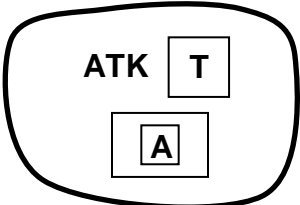
H.5.14 Maneuver control measure symbols.

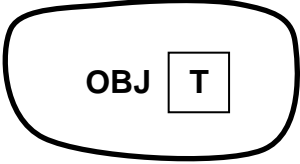
H.5.14.1 Maneuver control measure symbols. The employment of forces on the battlefield through movement in combination with fire, or fire potential, to achieve a position of advantage in respect to the enemy in order to accomplish the mission.

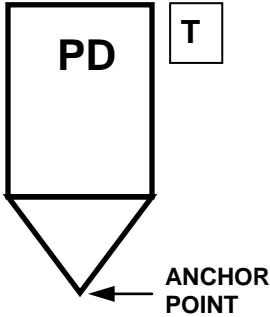
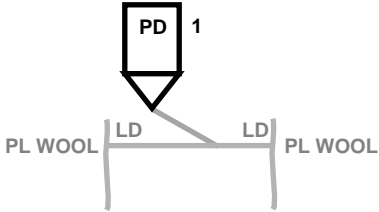
TABLE H-XII. Maneuver control measure symbols.

CONTROL MEASURE	TEMPLATE	DRAW RULES	EXAMPLE Note: The symbols that have been colored grey are used to help explain how the control measure is used, but they are not a part of the control measure.
<i>Areas</i>			
<p>Encirclement</p> <p>The loss of freedom of maneuver resulting from enemy control of all ground routes of evacuation and reinforcement.</p> <p>Symbol Set Code: 25 Code: 151800</p>	N/A		N/A
<p>Friendly</p> <p>Symbol Set Code: 25 Code: 151801</p>		<p><u>Anchor Points.</u> This symbol requires at least three anchor points to define the boundary of the area. Add as many points as necessary to accurately</p>	

TABLE H-XII. Maneuver control measure symbols - Continued.

CONTROL MEASURE	TEMPLATE	DRAW RULES	EXAMPLE Note: The symbols that have been colored grey are used to help explain how the control measure is used, but they are not a part of the control measure.
<p>Enemy</p> <p>Symbol Set Code: 25 Code: 151802</p>		<p>reflect the area's size and shape. <u>Size/Shape.</u> Determined by the anchor points. <u>Orientation.</u> Not applicable.</p> <p>Note: Although unit symbols are not part of a control measure symbol area, numerous unit symbols can be included in the area for presentation.</p> <p>Static/Dynamic: D</p>	
<p>Penetration Box</p> <p>Symbol Set Code: 25 Code: 151900</p> <p>Static/Dynamic: D</p>		<p><u>Anchor Points.</u> This graphic requires at least three anchor points to define the boundary of the area. Add as many points as necessary to accurately reflect the area's size and shape. <u>Size/Shape.</u> Determined by the anchor points. <u>Orientation.</u> Not applicable.</p>	

TABLE H-XII. Maneuver control measure symbols - Continued.

CONTROL MEASURE	TEMPLATE	DRAW RULES	EXAMPLE Note: The symbols that have been colored grey are used to help explain how the control measure is used, but they are not a part of the control measure.
<p>Attack By Fire Position</p> <p>Symbol Set Code: 25 Code: 152000</p> <p>Static/Dynamic: D</p>		<p><u>Anchor Points.</u> This symbol requires three anchor points. Point 1 is the tip of the arrowhead. Points 2 and 3 define the endpoints of the straight line on the back side of the symbol.</p> <p><u>Size/Shape.</u> Points 2 and 3 determine the length of the straight line on the back side of the symbol. The rear of the arrow should connect to the midpoint of the line between points 2 and 3.</p> <p><u>Orientation.</u> Orientation is determined by the anchor points. The back side of the symbol encompasses the firing position, while the arrowhead typically points at the target.</p>	

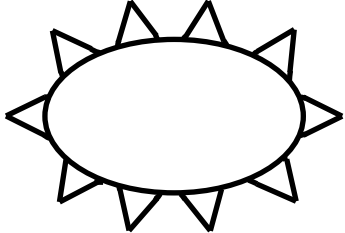
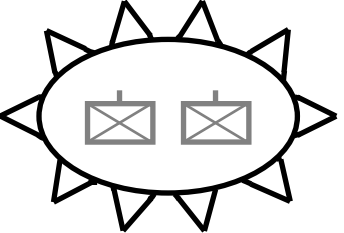
TABLE H-XII. Maneuver control measure symbols - Continued.

CONTROL MEASURE	TEMPLATE	DRAW RULES	EXAMPLE Note: The symbols that have been colored grey are used to help explain how the control measure is used, but they are not a part of the control measure.
<p>Support by Fire Position</p> <p>Symbol Set Code: 25 Code: 152100</p> <p>Static/Dynamic: D</p>		<p><u>Anchor Points.</u> This symbol requires four anchor points. Points 1 and 2 define the endpoints of the straight line on the back side of the symbol. Points 3 and 4 define the tips of the arrowheads.</p> <p><u>Size/Shape.</u> Points 1 and 2 determine the length of the straight line on the back side of the symbol. The rear of the arrows should connect to points 1 and 2.</p> <p><u>Orientation.</u> Orientation is determined by the anchor points. The back side of the symbol encompasses the firing position, while the arrowheads typically indicate the left and right limits of coverage that the firing position is meant to support.</p>	

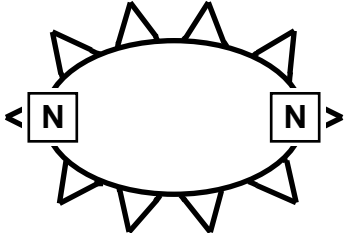
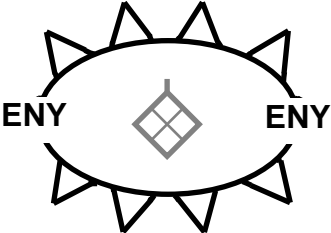
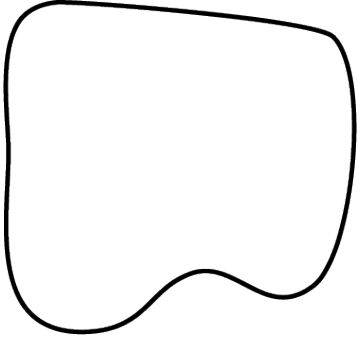
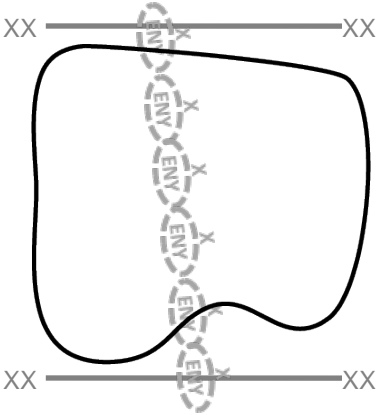
TABLE H-XII. Maneuver control measure symbols - Continued.

CONTROL MEASURE	TEMPLATE	DRAW RULES	EXAMPLE Note: The symbols that have been colored grey are used to help explain how the control measure is used, but they are not a part of the control measure.
<p>Search Area/Reconnaissance Area</p> <p>Symbol Set Code: 25 Code: 152200</p> <p>Static/Dynamic: D</p>		<p><u>Anchor Points.</u> This symbol requires three anchor points. Point 1 defines the vertex of the graphic. Points 2 and 3 define the tips of the arrowheads. <u>Size/Shape.</u> Points 1 and 2 and points 1 and 3 determine the length of the arrows. The length and orientation of the arrows can vary independently. <u>Orientation.</u> Orientation is determined by the anchor points. The arrowheads may touch other graphics that define the limits of the task. The tactical symbol indicator is centered over point 1.</p>	
<i>Lines</i>			

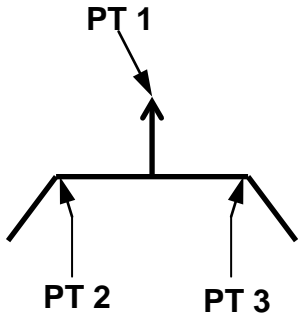
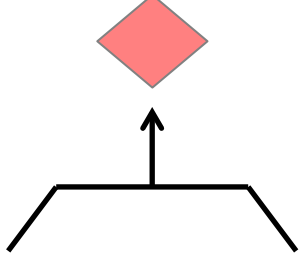
TABLE H-XII. Maneuver control measure symbols - Continued.

CONTROL MEASURE	TEMPLATE	DRAW RULES	EXAMPLE Note: The symbols that have been colored grey are used to help explain how the control measure is used, but they are not a part of the control measure.
<p>Airhead Line</p> <p>A line denoting the limits of the objective area for an airborne assault.</p> <p>Airhead: A designated area in a hostile or threatened territory which, when seized and held, ensures the continuous air landing of troops and materiel and provides the maneuver space necessary for projected operations. Normally it is the area seized in the assault phase of an airborne operation.</p> <p>Symbol Set Code: 25 Code: 141300</p>	 <p style="text-align: center;">AIRHEAD LINE</p>	<p><u>Anchor Points.</u> This symbol requires at least three anchor points to define the boundary of the area. Add as many points as necessary to accurately reflect the area's size and shape.</p> <p><u>Size/Shape.</u> Determined by the anchor points.</p> <p><u>Orientation.</u> Not applicable.</p> <p>Static/Dynamic: D</p>	 <p style="text-align: center;">AIRHEAD LINE</p>
<p>Bridgehead Line (BL)</p> <p>The limit of the objective area in the development of the bridgehead.</p> <p>Symbol Set Code: 25 Code: 141400</p>		<p><u>Anchor Points.</u> This symbol requires at least two points, points 1 and 2, to define the line. Additional points can be defined to extend the line.</p> <p><u>Size/Shape.</u> The first and last anchor points</p>	

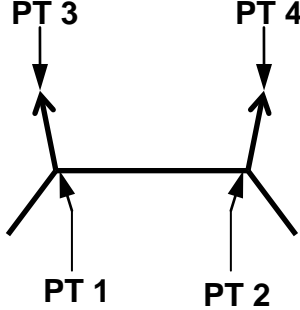
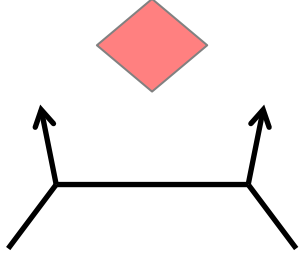
TABLE H-XII. Maneuver control measure symbols - Continued.

CONTROL MEASURE	TEMPLATE	DRAW RULES	EXAMPLE Note: The symbols that have been colored grey are used to help explain how the control measure is used, but they are not a part of the control measure.
<p>Holding Line (HL)</p> <p>In retrograde river crossing operations, the outer limit of the area established between the enemy and the water obstacle to preclude direct and observed indirect fires into the crossings.</p> <p>Symbol Set Code: 25 Code: 141500</p>		<p>determine the length of the line. The end-of line information will typically be posted as it is displayed on the screen.</p> <p><u>Orientation.</u> Orientation is determined by the order in which the anchor points are entered.</p> <p>Static/Dynamic: D</p>	
<p>Release Line</p> <p>Phase line used in river crossing operations that delineates a change in the headquarters controlling movement.</p> <p>Symbol Set Code: 25 Code: 141600</p>			

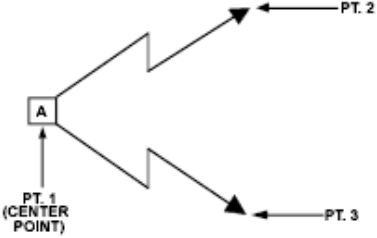
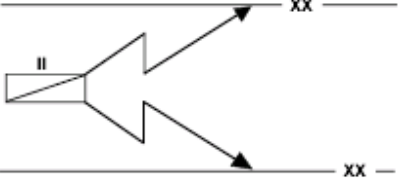
TABLE H-XII. Maneuver control measure symbols - Continued.

CONTROL MEASURE	TEMPLATE	DRAW RULES	EXAMPLE Note: The symbols that have been colored grey are used to help explain how the control measure is used, but they are not a part of the control measure.
<p>Ambush</p> <p>A surprise attack by fire from concealed positions on a moving or temporarily halted enemy.</p> <p>Symbol Set Code: 25 Code: 141700</p> <p>Static/Dynamic: D</p>	 <p>The template diagram shows a horizontal arrow pointing to the right. On the left side of the arrow, there is a curved line with several short horizontal bars extending from it. Three anchor points are labeled: PT 2 is at the top of the curved line, PT 3 is at the bottom of the curved line, and PT 1 is at the tip of the arrowhead.</p>	<p><u>Anchor Points.</u> This symbol requires three anchor points. Point 1 is the tip of the arrowhead. Points 2 and 3 define the endpoints of the curved line on the back side of the symbol.</p> <p><u>Size/Shape.</u> Points 2 and 3 determine the length of the curved line on the back side of the symbol. The rear of the arrow should connect to the midpoint of the line between points 2 and 3.</p> <p><u>Orientation.</u> Orientation is determined by the anchor points. The back side of the symbol encompasses the ambush position with the airhead shaft positioned at the center of mass, while the arrowhead points in the direction of fire.</p>	 <p>The example diagram shows the final symbol: a horizontal arrow pointing right with a curved line and horizontal bars on its back side.</p>

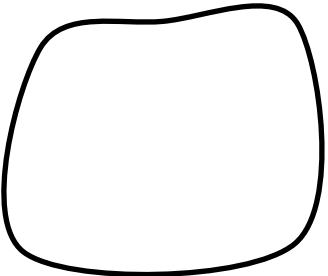
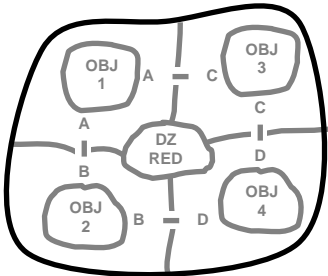
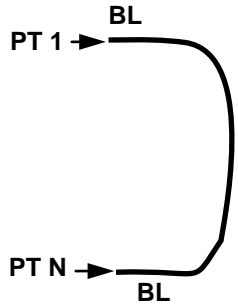
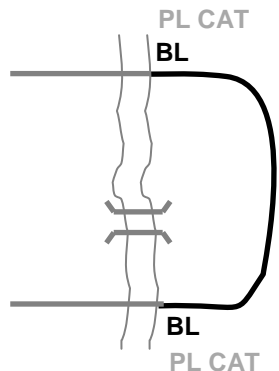
H.5.15 Airspace Control Measures (Means).

H.5.15.1 Airspace control measures (means). Are control measures used by NATO to segregate, control and/or reserve airspace for allied operations. Airspace control means are used to enhance the effectiveness of accomplishing the joint force commander’s objectives; to prevent mutual interference; to facilitate air defense identification; to prevent fratricide; and to help in safely accommodating the flow of all air traffic in the area of operations. In general terms, airspace control means can be broken down into the following groups: points, lines, air corridors and routes and areas.

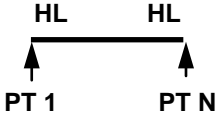
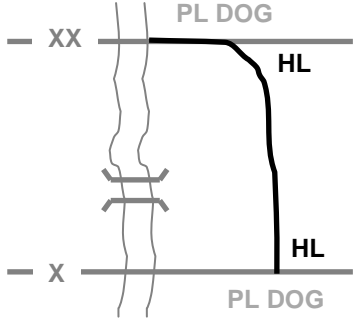
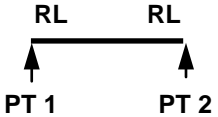
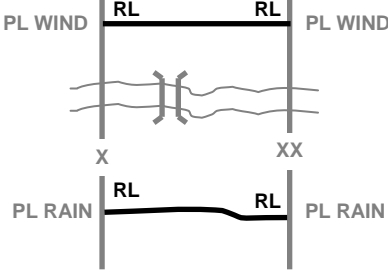
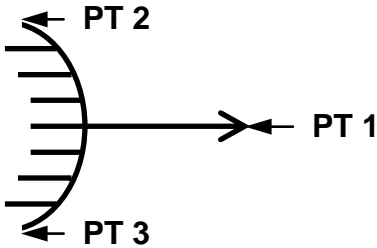
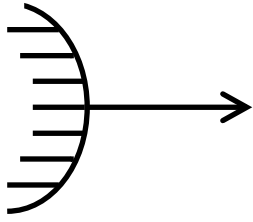
TABLE H-XIII. Airspace control means.



CONTROL MEASURE	TEMPLATE	DRAW RULES	EXAMPLE Note: The symbols that have been colored grey are used to help explain how the control measure is used, but they are not a part of the control measure.
<i>Corridors (Areas)</i>			
<p>Airspace Control (Corridors) Areas</p> <p>Symbol Set Code: 25 Code: 170000</p>	N/A		N/A
<p>Air Corridor</p> <p>A restricted air route of travel specified for use by friendly aircraft and established for the purpose of preventing friendly aircraft from being fired on by friendly forces.</p> <p>Symbol Set Code: 25 Code: 170100</p> <p>Static/Dynamic: D</p>	<p>NAME: T WIDTH: AM MIN ALT: X MAX ALT: X1 DTG START: W DTG END: W1</p> 	<p><u>Anchor Points.</u> This symbol may contain multiple segments. Each segment requires 2 anchor points. Point numbers that define the trace of the segment are sequential beginning with point 1, in increments of 1, up to a max of 99 points. Each anchor point defines the endpoint of a segment’s centerline. The anchor points are Air Control Points (ACP), Communications Checkpoints</p>	<p>NAME: GOLD WIDTH: 1200FT MIN ALT: 1500FT AGL MAX ALT: 20000FT AGL DTG START: 270600ZMAY08 DTG END: 271845ZMAY08</p> 

TABLE H-XIII. Airspace control means - Continued.

CONTROL MEASURE	TEMPLATE	DRAW RULES	EXAMPLE Note: The symbols that have been colored grey are used to help explain how the control measure is used, but they are not a part of the control measure.
		<p>(CCP) or both. <u>Size/Shape.</u> Points 1 and 2 determine the length of a segment. The information field inside each segment should be moveable and scalable within each segment. The information box outside the symbol should be placed between points 1 and 2 in such a way it does not obscure the symbol. <u>Orientation.</u> The anchor points determine orientation.</p>	
<p>Air Corridor with Multiple Segments</p>			<p>NAME: GOLD WIDTH: 1200FT MIN ALT: 1500FT AGL MAX ALT: 16000FT AGL DTG START: 240700ZSEP08 DTG END: 280700ZSEP08</p> 

TABLE H-XIII. Airspace control means - Continued.

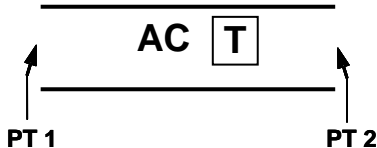

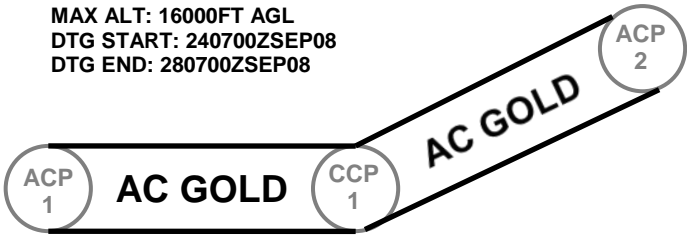

CONTROL MEASURE	TEMPLATE	DRAW RULES	EXAMPLE Note: The symbols that have been colored grey are used to help explain how the control measure is used, but they are not a part of the control measure.
<p>Low-Level Transit Route</p> <p>A temporary corridor of defined dimensions established in the forward area to minimize the risk to friendly aircraft from friendly air defenses or surface forces.</p> <p>Symbol Set Code: 25 Code: 170200</p>	<p>NAME: T WIDTH: AM MIN ALT: X MAX ALT: X1 DTG START: W DTG END: W1</p> 	<p><u>Anchor Points.</u> This symbol may contain multiple segments. Each segment requires 2 anchor points. Point numbers that define the trace of the segment are sequential beginning with point 1, in increments of 1, up to a max of 99 points. Each anchor point defines the endpoint of a segment's centerline. The anchor points are Air Control Points (ACP), Communication s Checkpoints (CCP) or both.</p> <p><u>Size/Shape.</u> Points 1 and 2 determine the length of a segment. The information field inside each segment should be moveable</p>	<p>NAME: COBRA WIDTH: 300FT MIN ALT: 150FT AGL MAX ALT: 3000FT AGL DTG START: 240500Z0CT08 DTG END: 241845Z0CT08</p> 
<p>Minimum-Risk Route</p> <p>A temporary route of defined dimensions recommended for use by fixed-wing platforms to route them between transit routes and the rear of the forward area and their operations areas. (AJP-3.3.5)</p> <p>Symbol Set Code: 25 Code: 170300</p>	<p>NAME: T WIDTH: AM MIN ALT: X MAX ALT: X1 DTG START: W DTG END: W1</p> 	<p><u>Anchor Points.</u> This symbol may contain multiple segments. Each segment requires 2 anchor points. Point numbers that define the trace of the segment are sequential beginning with point 1, in increments of 1, up to a max of 99 points. Each anchor point defines the endpoint of a segment's centerline. The anchor points are Air Control Points (ACP), Communication s Checkpoints (CCP) or both.</p> <p><u>Size/Shape.</u> Points 1 and 2 determine the length of a segment. The information field inside each segment should be moveable</p>	<p>NAME: RED WIDTH: 1500FT MIN ALT: 3000FT AGL MAX ALT: 21000FT AGL DTG START: 110200ZSEP08 DTG END: 140300ZSEP08</p> 

TABLE H-XIII. Airspace control means - Continued.





CONTROL MEASURE	TEMPLATE	DRAW RULES	EXAMPLE
<p>Safe Lane</p> <p>A bi-directional lane connecting an airbase, landing site and/or base defense zone to adjacent routes/corridors. Safe lanes may also be used to connect adjacent activated routes/corridors. (AJP-3.3.5)</p> <p>Symbol Set Code: 25 Code: 170400</p>	<p>NAME: T WIDTH: AM MIN ALT: X MAX ALT: X1 DTG START: W DTG END: W1</p> 	<p>and scalable within each segment. The information box outside the symbol should be placed between points 1 and 2 in such a way it does not obscure the symbol.</p> <p><u>Orientation.</u> The anchor points determine orientation.</p> <p>Static/Dynamic: D</p>	<p>Note: The symbols that have been colored grey are used to help explain how the control measure is used, but they are not a part of the control measure.</p> <p>NAME: LION WIDTH: 600FT MIN ALT: 600FT AGL MAX ALT: 3000FT AGL DTG START: 240730ZFEB08 DTG END: 280900ZFEB08</p> 
<p>Standard Use Army Aircraft Flight Route (SAAFR)</p> <p>Route established below the coordination level to facilitate movement of army aviation assets in the forward area in direct support of ground operations. (AJP-3.3.5)</p> <p>Symbol Set Code: 25 Code: 170500</p>	<p>NAME: T WIDTH: AM MIN ALT: X MAX ALT: X1 DTG START: W DTG END: W1</p> 		<p>NAME: BLUE WIDTH: 600FT MIN ALT: 150FT AGL MAX ALT: 3000FT AGL DTG START: 260930ZMAY08 DTG END: 280700ZMAY08</p> 

TABLE H-XIII. Airspace control means - Continued.



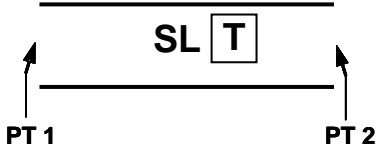

CONTROL MEASURE	TEMPLATE	DRAW RULES	EXAMPLE Note: The symbols that have been colored grey are used to help explain how the control measure is used, but they are not a part of the control measure.
<p>Transit Corridors</p> <p>Bi-directional and established to route aircraft through air defenses, in the rear area where appropriate, with minimum risk.</p> <p>Symbol Set Code: 25 Code: 170600</p>	<p>NAME: T WIDTH: AM MIN ALT: X MAX ALT: X1 DTG START: W DTG END: W1</p> 		<p>NAME: KING WIDTH: 900FT MIN ALT: 2100FT AGL MAX ALT: 6000FT AGL DTG START: 260700ZMAR08 DTG END: 280700ZMAR08</p> 
<p>Unmanned Aircraft (UA) Route</p> <p>Airspace created specifically for unmanned aerial vehicle operations. (AJP-3.3.5)</p> <p>Symbol Set Code: 25 Code: 170700</p>	<p>NAME: T WIDTH: AM MIN ALT: X MAX ALT: X1 DTG START: W DTG END: W1</p> 		<p>NAME: DRAGON WIDTH: 1200FT MIN ALT: 1500FT AGL MAX ALT: 12000FT AGL DTG START: 200700ZMAY08 DTG END: 210700ZMAY08</p> 
Areas (Zones)			
<p>Base Defense Zone.</p> <p>A zone established around airbases to enhance the effectiveness of local ground based air defense systems. (AJP 3.3.5)</p> <p>Symbol Set Code: 25 Code: 170800</p>		<p><u>Anchor Points.</u> This symbol requires one anchor point. The center point defines the center of the symbol. <u>Size/Shape.</u> Static. <u>Orientation.</u> The symbol is typically centered over the desired location.</p>	

TABLE H-XIII. Airspace control means - Continued.

CONTROL MEASURE	TEMPLATE	DRAW RULES	EXAMPLE Note: The symbols that have been colored grey are used to help explain how the control measure is used, but they are not a part of the control measure.
<p>High-Density Airspace Control Zone</p> <p>Airspace of defined dimensions, designated by the airspace control authority, in which there is a concentrated employment of numerous and varied weapons/airspace users.</p> <p>Symbol Set Code: 25 Code: 170900</p>	 <p>HIDACZ T MIN ALT: X MAX ALT: X1 TIME FROM: W TIME TO: W1</p>	<p><u>Anchor Points.</u> This symbol requires at least three anchor points to define the boundary of the area. Add as many points as necessary to accurately reflect the area's size and shape.</p> <p><u>Size/Shape.</u> Determined by the anchor points. The information fields should be moveable and scalable as a block within the area.</p> <p><u>Orientation.</u> Not applicable.</p> <p>Static/Dynamic: D</p>	 <p>HIDACZ 32AADC MIN ALT: 450000FT AGL MAX ALT: 1110000FT AGL TIME FROM: 120700ZMAY08 TIME TO: 140630ZMAY08</p>

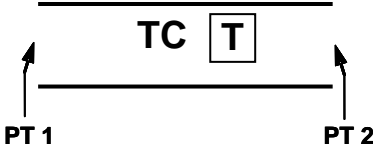
TABLE H-XIII. Airspace control means - Continued.

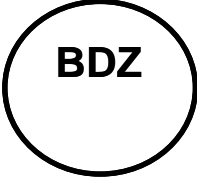
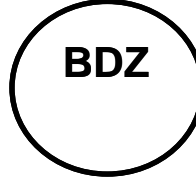

CONTROL MEASURE	TEMPLATE	DRAW RULES	EXAMPLE Note: The symbols that have been colored grey are used to help explain how the control measure is used, but they are not a part of the control measure.
Restricted Operations Zones			
<p>Restricted Operations Zone (ROZ)</p> <p>Airspace of defined dimensions, designated by the airspace control authority, in response to specific operational situations/requirements within which the operation of one or more airspace users is restricted.</p> <p><i>Note:</i> This is the definition for restricted operations area.</p> <p>Symbol Set Code: 25 Code: 171000</p>	 <p>ROZ T MIN ALT: X MAX ALT: X1 TIME FROM: W TIME TO: W1</p>	<p><u>Anchor Points.</u> This symbol requires at least three anchor points to define the boundary of the area. Add as many points as necessary to accurately reflect the area's size and shape.</p> <p><u>Size/Shape.</u> Determined by the anchor points. The information fields should be moveable and scalable as a block within the area.</p> <p><u>Orientation.</u> Not applicable.</p> <p>Static/Dynamic: D</p>	 <p>ROZ 11 ADA BDE MIN ALT: 2700FT AGL MAX ALT: 21000FT AGL TIME FROM: 030001ZJUL08 TIME TO: 032400ZJUL08</p>
<p>Air-to-Air Restricted Operations Zone (AARROZ)</p> <p>Symbol Set Code: 25 Code: 171100</p>	 <p>AARROZ T MIN ALT: X MAX ALT: X1 TIME FROM: W TIME TO: W1</p>		 <p>AARROZ 2ID MIN ALT: 750FT AGL MAX ALT: 21000FT AGL TIME FROM: 201200ZAPR08 TIME TO: 232100ZAPR08</p>

TABLE H-XIII. Airspace control means - Continued.

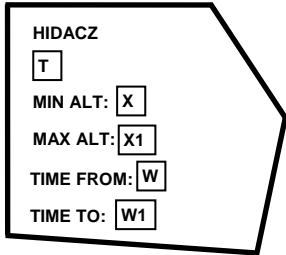
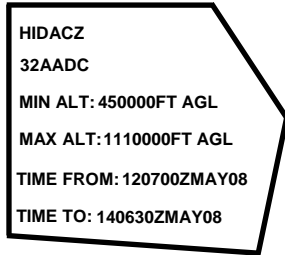
CONTROL MEASURE	TEMPLATE	DRAW RULES	EXAMPLE Note: The symbols that have been colored grey are used to help explain how the control measure is used, but they are not a part of the control measure.
<p>Unmanned Aircraft Restricted Operations Zone (UA-ROZ)</p> <p>Symbol Set Code: 25 Code: 171200</p>	 <p>UAROZ T MIN ALT: X MAX ALT: X1 TIME FROM: W TIME TO: W1</p>		 <p>UAVROZ MND(N) MIN ALT: 75FT AGL MAX ALT: 6000FT AGL TIME FROM: 190500ZDEC07 TIME TO: 262400ZDEC07</p>
Weapons Engagement Zones			
<p>Weapon Engagement Zone</p> <p>In air defense, airspace of defined dimensions within which the responsibility for engagement normally rests with a particular weapon system. <i>Note:</i> Includes FEZ, JEZ, MEZ (LOMEZ and HIMEZ), SHORADEZ.</p> <p>Symbol Set Code: 25 Code: 171300</p>	 <p>WEZ T MIN ALT: X MAX ALT: X1 TIME FROM: W TIME TO: W1</p>	<p><u>Anchor Points.</u> This symbol requires at least three anchor points to define the boundary of the area. Add as many points as necessary to accurately reflect the area's size and shape.</p> <p><u>Size/Shape.</u> Determined by the anchor points. The information fields should be moveable and scalable as a block within the area.</p>	 <p>WEZ 21 ADA BN MIN ALT: 300FT AGL MAX ALT: 102000FT AGL TIME FROM: 040030ZJAN08 TIME TO: 040029ZJAN08</p>

TABLE H-XIII. Airspace control means - Continued.

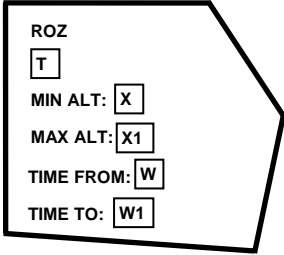
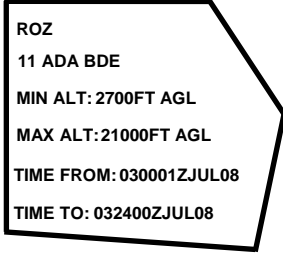
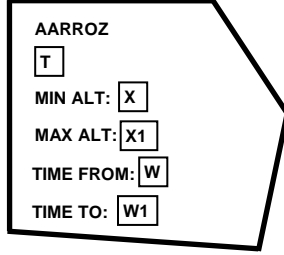
CONTROL MEASURE	TEMPLATE	DRAW RULES	EXAMPLE Note: The symbols that have been colored grey are used to help explain how the control measure is used, but they are not a part of the control measure.
<p>Fighter Engagement Zone (FEZ)</p> <p>In air defense, airspace of defined dimensions within which the responsibility for engagement normally rests with a particular weapon system.</p> <p>Symbol Set Code: 25 Code: 171400</p>	 <p>FEZ T MIN ALT: X MAX ALT: X1 TIME FROM: W TIME TO: W1</p>	<p><u>Orientation.</u> Not applicable.</p> <p>Static/Dynamic: D</p>	 <p>FEZ ATF MIN ALT: 750FT AGL MAX ALT: 150000FT AGL TIME FROM: 030100Z0CT08 TIME TO: 210100ZDEC08</p>
<p>Joint Engagement Zone (JEZ)</p> <p>Symbol Set Code: 25 Code: 171500</p> <p>In air defense, that airspace of Defined dimensions within which multiple air defense systems (surface-to-air missiles and aircraft) are simultaneously employed to engage air threats.</p>	 <p>JEZ T MIN ALT: X MAX ALT: X1 TIME FROM: W TIME TO: W1</p>		 <p>JEZ ATF MIN ALT: 300FT AGL MAX ALT: 120000FT AGL TIME FROM: 310100Z0CT08 TIME TO: 010100ZNOV08</p>

TABLE H-XIII. Airspace control means - Continued.

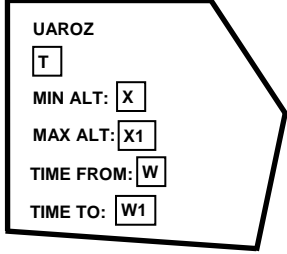
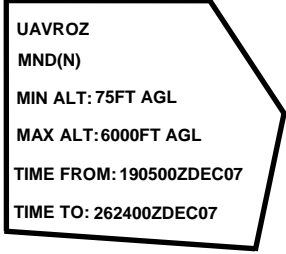
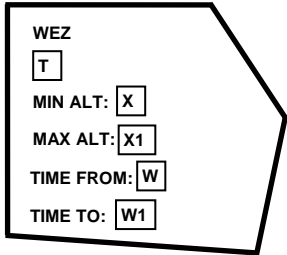
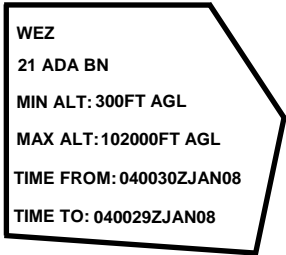

CONTROL MEASURE	TEMPLATE	DRAW RULES	EXAMPLE Note: The symbols that have been colored grey are used to help explain how the control measure is used, but they are not a part of the control measure.
<p>Missile Engagement Zone (MEZ)</p> <p>In air defense, airspace of defined dimensions within which the responsibility for engagement normally rests with a particular weapon system.</p> <p>Symbol Set Code: 25 Code: 171600</p>	 <p>MEZ T MIN ALT: X MAX ALT: X1 TIME FROM: W TIME TO: W1</p>		 <p>MEZ 2-4 ADA BN MIN ALT: 6000FT AGL MAX ALT: 45000FT AGL TIME FROM: 160100ZFEB08 TIME TO: 150100ZMAR08</p>
<p>Low (Altitude) Missile Engagement Zone (LOMEZ)</p> <p>Symbol Set Code: 25 Code: 171700</p>	 <p>LOMEZ T MIN ALT: X MAX ALT: X1 TIME FROM: W TIME TO: W1</p>		 <p>LOMEZ AACC MIN ALT: 300FT AGL MAX ALT: 6000FT AGL TIME FROM: 070600ZAUG08 TIME TO: 071600ZAUG08</p>
<p>High (Altitude) Missile Engagement Zone (HIMEZ)</p> <p>Symbol Set Code: 25 Code: 171800</p>	 <p>HIMEZ T MIN ALT: X MAX ALT: X1 TIME FROM: W TIME TO: W1</p>		 <p>HIMEZ AACC MIN ALT: 6000FT AGL MAX ALT: 150000FT AGL TIME FROM: 070600ZAUG08 TIME TO: 071600ZAUG08</p>

TABLE H-XIII. Airspace control means - Continued.

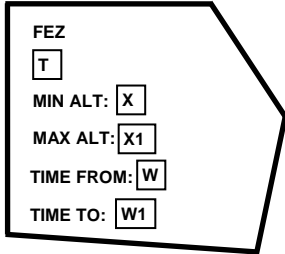
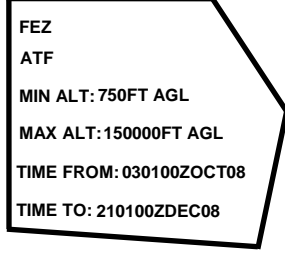
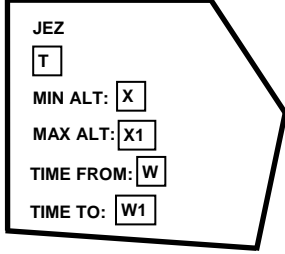
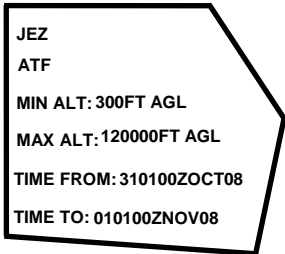
CONTROL MEASURE	TEMPLATE	DRAW RULES	EXAMPLE Note: The symbols that have been colored grey are used to help explain how the control measure is used, but they are not a part of the control measure.
<p>Short Range Air Defense Engagement Zone (SHORADEZ)</p> <p>In air defense, airspace of defined dimensions within which the responsibility for engagement normally rests with a particular weapon system.</p> <p>Note: Replaces Forward Area Air Defense Engagement Zone (FAADEZ)</p> <p>Symbol Set Code: 25 Code: 171900</p>	 <p>SHORADEZ</p> <p>T</p> <p>MIN ALT: X</p> <p>MAX ALT: X1</p> <p>TIME FROM: W</p> <p>TIME TO: W1</p>		 <p>SHORADEZ</p> <p>ATF</p> <p>MIN ALT: 300FT AGL</p> <p>MAX ALT: 24000FT AGL</p> <p>TIME FROM: 240600ZAUG08</p> <p>TIME TO: 242300ZAUG08</p>

TABLE H-XIII. Airspace control means - Continued.

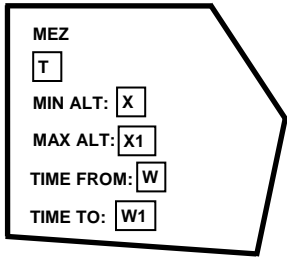
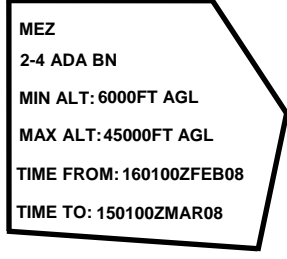
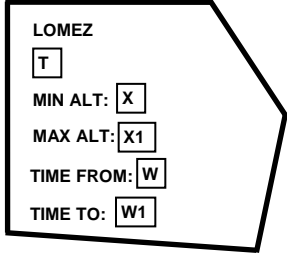

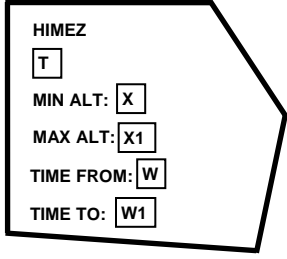
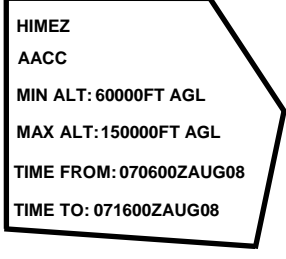
CONTROL MEASURE	TEMPLATE	DRAW RULES	EXAMPLE Note: The symbols that have been colored grey are used to help explain how the control measure is used, but they are not a part of the control measure.
<p>Weapons Free Zone</p> <p>An air defense zone established around key assets or facilities other than airbases which merit special protection by ground based air defense assets where weapons may be fired at any target not positively identified as friendly. (AJP-3.3.5)</p> <p>Note: Upward diagonal lines are part of the fill.</p> <p>Symbol Set Code: 25 Code: 172000</p>			
<i>Points</i>			
<p>Airspace Control Points</p> <p>Symbol Set Code: 25 Code: 180000</p>	<p style="text-align: center;">Center Point</p> 	<p><u>Anchor Points.</u> This graphic requires one anchor point. The center point defines the center of the graphic. <u>Size/Shape.</u> Static.</p>	

TABLE H-XIII. Airspace control means - Continued.

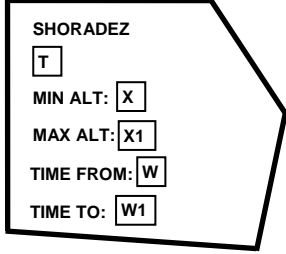
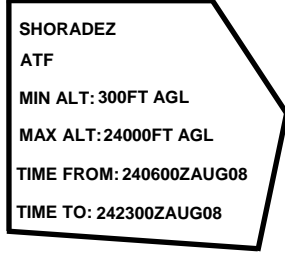

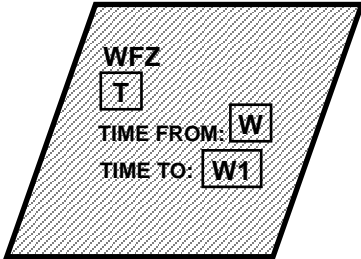

CONTROL MEASURE	TEMPLATE	DRAW RULES	EXAMPLE Note: The symbols that have been colored grey are used to help explain how the control measure is used, but they are not a part of the control measure.
<p>Air Control Point</p> <p>Symbol Set Code: 25 Code: 180100</p>		<p><u>Orientation.</u> The graphic is typically centered over the desired location.</p> <p>Static/Dynamic: S</p>	
<p>Communications Check Point</p> <p>Symbol Set Code: 25 Code: 180200</p>			
<p>Downed Aircrew Pick-Up Point</p> <p>Symbol Set Code: 25 Code: 180300</p> <p>Static/Dynamic: S</p>		<p><u>Anchor Points.</u> This symbol requires one anchor point. The point defines the tip of the inverted cone.</p> <p><u>Size/Shape.</u> Static.</p> <p><u>Orientation.</u> The symbol will typically be oriented upright.</p>	
<p>Pop-Up Point (PUP)</p> <p>The location at which aircraft quickly gain altitude for target acquisition and engagement.</p> <p>Symbol Set Code: 25 Code: 180400</p>		<p><u>Anchor Points.</u> This symbol requires one anchor point. The center point defines the center of the symbol.</p> <p><u>Size/Shape.</u> Static.</p> <p><u>Orientation.</u> The symbol is typically centered over</p>	

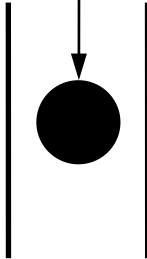
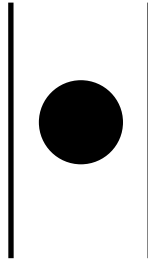
TABLE H-XIII. Airspace control means - Continued.



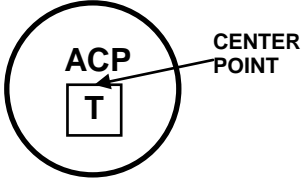

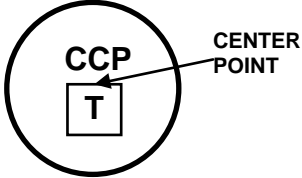
CONTROL MEASURE	TEMPLATE	DRAW RULES	EXAMPLE Note: The symbols that have been colored grey are used to help explain how the control measure is used, but they are not a part of the control measure.
Air Control Rendezvous Symbol Set Code: 25 Code: 180500	Center Point 	the desired location. Static/Dynamic: S	
TACAN Symbol Set Code: 25 Code: 180600	Center Point 		
CAP Station Symbol Set Code: 25 Code: 180700	Center Point 		
AEW Station Symbol Set Code: 25 Code: 180800	Center Point 		
ASW (Helo and F/W) Station Symbol Set Code: 25 Code: 180900	Center Point 		
Strike Initial Point Symbol Set Code: 25 Code: 181000	Center Point 		

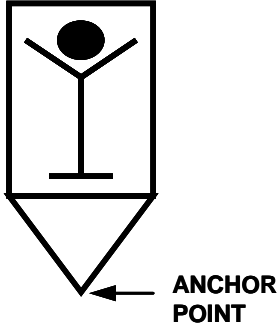
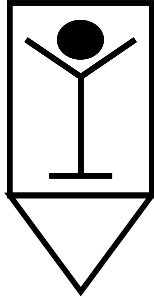
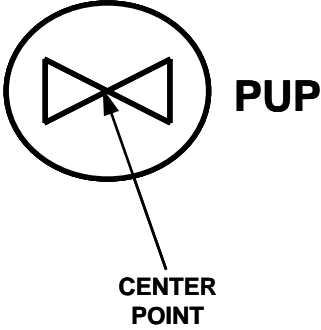
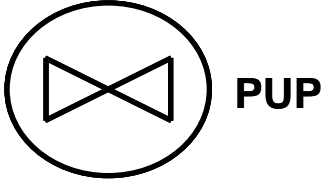
TABLE H-XIII. Airspace control means - Continued.



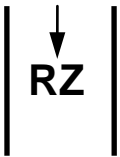

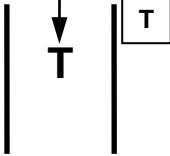

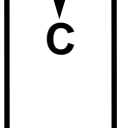
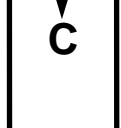
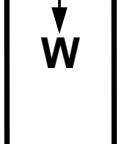
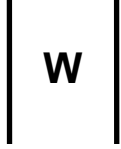
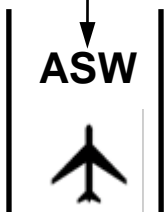
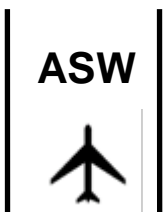
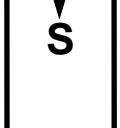
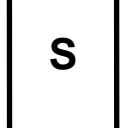

CONTROL MEASURE	TEMPLATE	DRAW RULES	EXAMPLE Note: The symbols that have been colored grey are used to help explain how the control measure is used, but they are not a part of the control measure.
Replenishment Station Symbol Set Code: 25 Code: 181100	Center Point 		
Tanking Symbol Set Code: 25 Code: 181200	Center Point 		
Antisubmarine Warfare, Rotary Wing Symbol Set Code: 25 Code: 181300	CENTER POINT 		
SUCAP – Fixed Wing Symbol Set Code: 25 Code: 181400	CENTER POINT 		
SUCAP – Rotary Wing Symbol Set Code: 25 Code: 181500	CENTER POINT 		

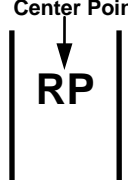
TABLE H-XIII. Airspace control means - Continued.

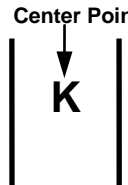
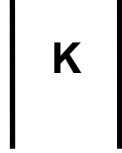









CONTROL MEASURE	TEMPLATE	DRAW RULES	EXAMPLE Note: The symbols that have been colored grey are used to help explain how the control measure is used, but they are not a part of the control measure.
<p>MIW – Fixed Wing</p> <p>Symbol Set Code: 25 Code: 181600</p>			
<p>MIW – Rotary Wing</p> <p>Symbol Set Code: 25 Code: 181700</p>			
<p>Tomcat</p> <p>Symbol Set Code: 25 Code: 181800</p>			
<p>Rescue</p> <p>Symbol Set Code: 25 Code: 181900</p>			
<p>Unmanned Aerial System (UAS/UA)</p> <p>Symbol Set Code: 25 Code: 182000</p>			

TABLE H-XIII. Airspace control means - Continued.

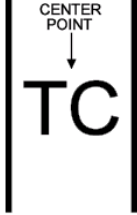

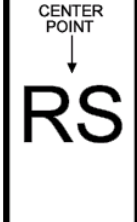









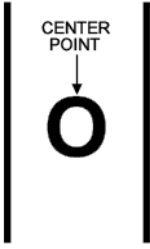

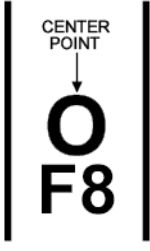
CONTROL MEASURE	TEMPLATE	DRAW RULES	EXAMPLE Note: The symbols that have been colored grey are used to help explain how the control measure is used, but they are not a part of the control measure.
VTUA Symbol Set Code: 25 Code: 182100			
Orbit Symbol Set Code: 25 Code: 182200			
Orbit – Figure Eight Symbol Set Code: 25 Code: 182300			
Orbit – Race Track Symbol Set Code: 25 Code: 182400			
Orbit – Random Closed Symbol Set Code: 25 Code: 182500			

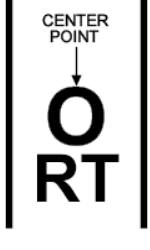
TABLE H-XIII. Airspace control means - Continued.

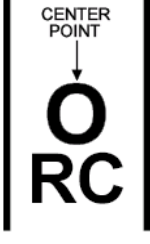
CONTROL MEASURE	TEMPLATE	DRAW RULES	EXAMPLE Note: The symbols that have been colored grey are used to help explain how the control measure is used, but they are not a part of the control measure.
<i>Lines</i>			
Airspace Control Lines Symbol Set Code: 25 Code: 190000	N/A		N/A
Identification, Friend-or-Foe (IFF) Off Line Line demarking where friendly aircraft en-route to targets stop emitting an IFF signal. (AJP-3.5.5) Symbol Set Code: 25 Code: 190100		<u>Anchor Points.</u> This symbol requires at least two points, points 1 and 2, to define the line. Additional points can be defined to extend the line. <u>Size/Shape.</u> The first and last anchor points determine the length of the line. The end-of line information will typically be posted at the ends of the line as it is displayed on the screen. <u>Orientation.</u> Orientation is determined by the order in which the anchor points are entered. Static/Dynamic: D	IFF OFF IFF OFF 
Identification, Friend-or-Foe (IFF) On Line Line demarking where friendly aircraft returning to friendly territory start emitting an IFF signal. (AJP-3.5.5) Symbol Set Code: 25 Code: 190200		Static/Dynamic: D	IFF ON IFF ON 

H.5.16 Maritime control measures.

H.5.16.1 Maritime control measures. Are used by NATO to help the maritime component commander and his subordinate commanders to direct action by establishing responsibilities and to prevent ships, units, or aircraft from impeding one another and to impose necessary coordination. They aide the cooperation among forces without imposing needless restrictions on their freedom of action. In general terms, maritime control measures can be broken down into the following groups: points, lines and areas.

TABLE H-XIV. Maritime control measures.

CONTROL MEASURE	TEMPLATE	DRAW RULES	EXAMPLE Note: The symbols that have been colored grey are used to help explain how the control measure is used, but they are not a part of the control measure.
Maritime Control Area Symbol Set Code: 25 Code: 200000	N/A		N/A
Launch Area Symbol Set Code: 25 Code: 200100	N/A		N/A

TABLE H-XIV. Maritime control measures - Continued.



CONTROL MEASURE	TEMPLATE	DRAW RULES	EXAMPLE Note: The symbols that have been colored grey are used to help explain how the control measure is used, but they are not a part of the control measure.
<p>Launch Area, Ellipse/Circle (AEGIS only)</p> <p>Symbol Set Code: 25 Code: 200101</p> <p>Static/Dynamic: D</p> <p>Note: Launch Area may be depicted as orange (RGB: 255,155,0) where, the area fill is 75% transparent.</p>		<p><u>Anchor Points.</u> This symbol requires one anchor point. This anchor point represents the center of an ellipse and, therefore, the geographic location of that ellipse.</p> <p><u>Size/Shape.</u> The size and shape of this symbol is determined by three additional numeric values; A major axis radius, a minor axis radius, and a rotation angle. The radii should be expressed in the appropriate map distance units.</p> <p><u>Orientation.</u> The orientation of this symbol is determined by the rotation angle provided, where 0 degrees is east/west and a positive rotation angle rotates the ellipse in a counter-clockwise direction.</p>	 
<p>Defended Area</p> <p>Symbol Set Code: 25 Code: 200200</p>	<p>N/A</p>	<p>N/A</p>	<p>N/A</p>

TABLE H-XIV. Maritime control measures - Continued.

CONTROL MEASURE	TEMPLATE	DRAW RULES	EXAMPLE Note: The symbols that have been colored grey are used to help explain how the control measure is used, but they are not a part of the control measure.
<p>Defended Area, Ellipse/Circle (AEGIS only)</p> <p>Symbol Set Code: 25 Code: 200201</p> <p>Static/Dynamic: D</p> <p>Note: Defended Area may be depicted as grey (RGB:85,119,136) where the grey area fill is 75% transparent.</p>		<p><u>Anchor Points.</u> This symbol requires one anchor point. This anchor point represents the center of an ellipse and, therefore, the geographic location of that ellipse.</p> <p><u>Size/Shape.</u> The size and shape of this symbol is determined by three additional numeric values; A major axis radius, a minor axis radius, and a rotation angle. The radii should be expressed in the appropriate map distance units.</p> <p><u>Orientation.</u> The orientation of this symbol is determined by the rotation angle provided, where 0 degrees is east/west and a positive rotation angle rotates the ellipse in a counter-clockwise direction.</p>	

TABLE H-XIV. Maritime control measures - Continued.

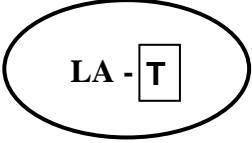
CONTROL MEASURE	TEMPLATE	DRAW RULES	EXAMPLE Note: The symbols that have been colored grey are used to help explain how the control measure is used, but they are not a part of the control measure.
<p>Defended Area, Rectangle (AEGIS only)</p> <p>Symbol Set Code: 25 Code: 200202</p> <p>Static/Dynamic: D</p> <p>Note: Defended Area may be depicted as grey (RGB:85,119,136) where the grey area fill is 75% transparent.</p>		<p><u>Anchor Points.</u> This symbol requires two anchor points and a width, defined in meters, to define the boundary of the area. Points 1 and 2 will be located in the center of two opposing sides of the rectangle.</p> <p><u>Size/Shape.</u> Size: As determined by the anchor points. The anchor points determine the length of the rectangle. The width, defined in meters, will determine the width of the rectangle.</p> <p>Shape: Rectangle. The information fields should be moveable and scalable.</p> <p><u>Orientation.</u> As determined by the anchor points.</p>	

TABLE H-XIV. Maritime control measures - Continued.

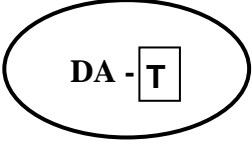
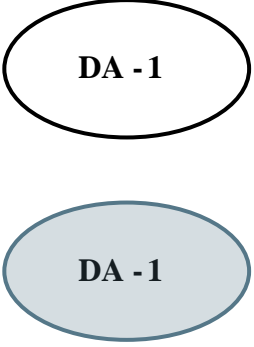

CONTROL MEASURE	TEMPLATE	DRAW RULES	EXAMPLE Note: The symbols that have been colored grey are used to help explain how the control measure is used, but they are not a part of the control measure.
<p>No Attack (NOTACK) Zone (AEGIS only)</p> <p>Symbol Set Code: 25 Code: 200300</p> <p>Static/Dynamic: D</p>		<p><u>Anchor Points.</u> This symbol requires one anchor point and a radius. Point 1 defines the center point of the symbol.</p> <p><u>Size/Shape.</u> Size: The radius defines the size. Shape: Circle. The information fields should be scalable within the circle.</p> <p><u>Orientation.</u> Not applicable</p>	
<p>Ship Area of Interest (AEGIS only)</p> <p>Symbol Set Code: 25 Code: 200400</p> <p>Static/Dynamic: S</p> <p>Note: Maneuver areas can only occur within a Ship AOI graphic.</p>		<p><u>Anchor Points.</u> This symbol requires one anchor point. The center point defines the center of the symbol.</p> <p><u>Size/Shape.</u> Static. Maneuver area graphic shall be drawn with a black border. Maneuver areas may be either unfilled or filled with performance-contoured color options.</p> <p><u>Orientation.</u> The symbol is typically centered over the desired location.</p>	

TABLE H-XIV. Maritime control measures - Continued.

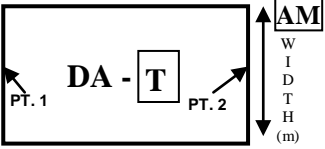
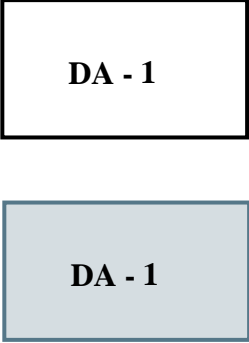
CONTROL MEASURE	TEMPLATE	DRAW RULES	EXAMPLE Note: The symbols that have been colored grey are used to help explain how the control measure is used, but they are not a part of the control measure.
<p>Ship Area of Interest, Eclipse/Circle (AEGIS only)</p> <p>Symbol Set Code: 25 Code: 200401</p> <p>Static/Dynamic: D</p>	 <p style="text-align: center;">AOI</p>	<p><u>Anchor Points.</u> This symbol requires at least three anchor points to define the boundary of the area. Add as many points as necessary to accurately reflect the area's size and shape.</p> <p><u>Size/Shape.</u> Determined by the anchor points. The information fields should be moveable and scalable as a block within the area.</p> <p><u>Orientation.</u> Not applicable.</p>	 <p style="text-align: center;">AOI</p> <p style="text-align: center;">White-Colored Option</p>  <p style="text-align: center;">AOI</p>

TABLE H-XIV. Maritime control measures - Continued.

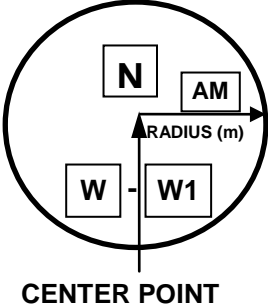
CONTROL MEASURE	TEMPLATE	DRAW RULES	EXAMPLE Note: The symbols that have been colored grey are used to help explain how the control measure is used, but they are not a part of the control measure.
<p>Ship Area of Interest, Rectangle (AEGIS only)</p> <p>Symbol Set Code: 25 Code: 200402</p> <p>Static/Dynamic: D</p>	 <p style="text-align: center;">AOI</p>	<p><u>Anchor Points.</u> This symbol requires two anchor points and a width, defined in meters, to define the boundary of the area. Points 1 and 2 will be located in the center of two opposing sides of the rectangle.</p> <p><u>Size/Shape.</u> Size: As determined by the anchor points. The anchor points determine the length of the rectangle. The width, defined in meters, will determine the width of the rectangle.</p> <p>Shape: Rectangle. The information fields should be moveable and scalable.</p> <p><u>Orientation.</u> As determined by the anchor points.</p>	

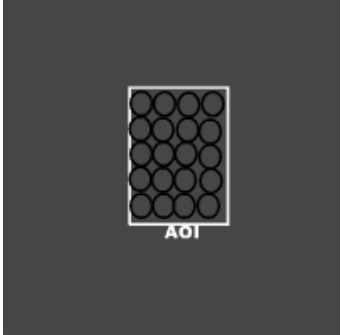
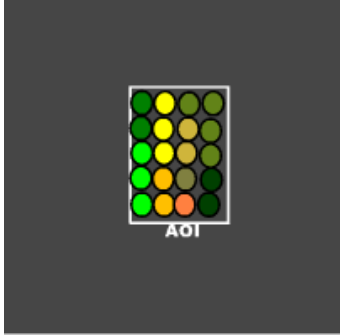
TABLE H-XIV. Maritime control measures - Continued.

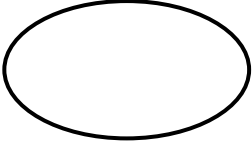
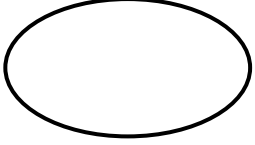
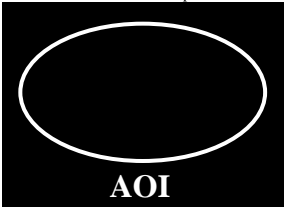

CONTROL MEASURE	TEMPLATE	DRAW RULES	EXAMPLE Note: The symbols that have been colored grey are used to help explain how the control measure is used, but they are not a part of the control measure.
<p>Active Maneuver Area (AEGIS only)</p> <p>Symbol Set Code: 25 Code: 200500</p>	 <p>CENTER POINT</p>	<p><u>Anchor Points:</u> This symbol requires one anchor point. The center point defines/is the center of the symbol.</p> <p><u>Size/Shape:</u> Static.</p> <p><u>Orientation:</u> The symbol is typically centered over the desired location.</p>	
<p>Cued Acquisition Doctrine (AEGIS only)</p> <p>Symbol Set Code: 25 Code: 200600</p> <p>Note: Cued Acquisition Doctrine symbol has a white border (RGB: 255,255,255) with a 75% transparent Grey fill (RGB: 85.119,136)</p>	 <p>Center Point</p>	<p>Static/Dynamic: S</p>	
<p>Radar Search Doctrine (AEGIS only)</p> <p>Symbol Set Code: 25 Code: 200700</p> <p>Note: RSD Graphic has a dark cyan border (RGB: 51,136,136) with a 75% transparent dark cyan fill (RGB: 51,136,136)</p>	 <p>Center Point</p>		

TABLE H-XIV. Maritime control measures - Continued.

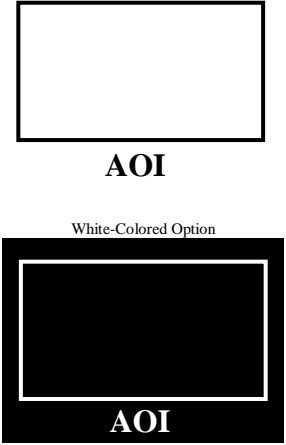

CONTROL MEASURE	TEMPLATE	DRAW RULES	EXAMPLE Note: The symbols that have been colored grey are used to help explain how the control measure is used, but they are not a part of the control measure.
Maritime Control Points Symbol Set Code: 25 Code: 210000	N/A		N/A
Plan Ship Symbol Set Code: 25 Code: 210100		<u>Anchor Points:</u> This symbol requires one anchor point. The center point defines/is the center of the symbol.	
Aim Point Symbol Set Code: 25 Code: 210200		<u>Size/Shape:</u> Static. <u>Orientation:</u> The symbol is typically centered over the desired location.	
Defended Asset Symbol Set Code: 25 Code: 210300		Static/Dynamic: S	3FLT 

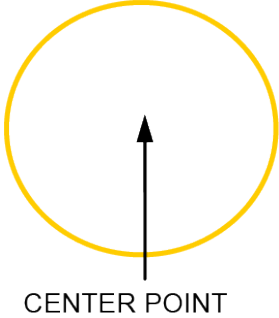
TABLE H-XIV. Maritime control measures - Continued.

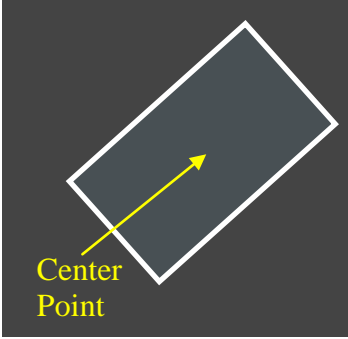
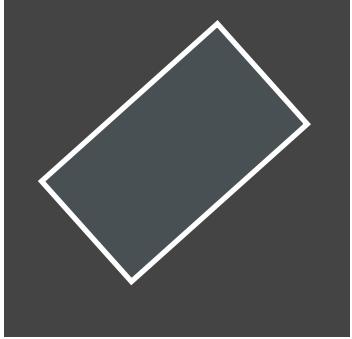
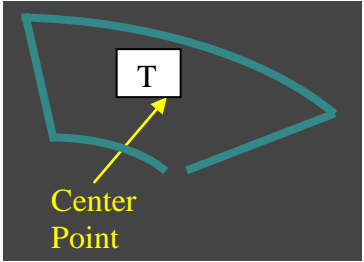
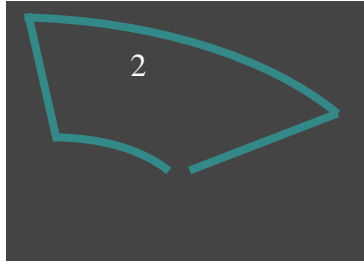
CONTROL MEASURE	TEMPLATE	DRAW RULES	EXAMPLE Note: The symbols that have been colored grey are used to help explain how the control measure is used, but they are not a part of the control measure.
<p>Drop Point</p> <p>Symbol Set Code: 25 Code: 210400</p> <p>Static/Dynamic: S</p>		<p><u>Anchor Points.</u> This symbol requires one anchor point. The point defines the bottom of the central vertical line in the symbol where the curved and vertical lines meet.</p> <p><u>Size/Shape.</u> Static.</p> <p><u>Orientation.</u> The symbol will typically be oriented upright.</p>	
<p>Entry Point</p> <p>Symbol Set Code: 25 Code: 210500</p> <p>Static/Dynamic: S</p>		<p><u>Anchor Points.</u> This symbol requires one anchor point. The point defines the point where all the lines meet.</p> <p><u>Size/Shape.</u> Static.</p> <p><u>Orientation.</u> The symbol will typically be oriented upright.</p>	

TABLE H-XIV. Maritime control measures - Continued.

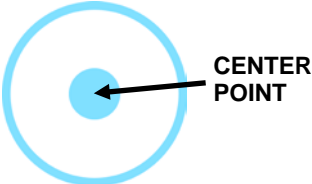

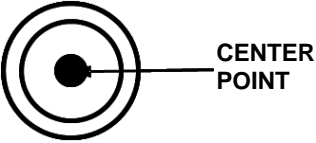
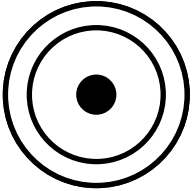
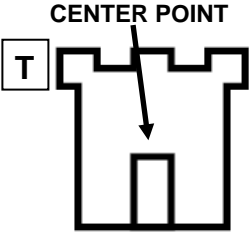
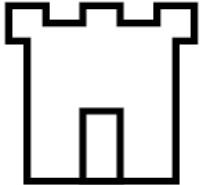

CONTROL MEASURE	TEMPLATE	DRAW RULES	EXAMPLE Note: The symbols that have been colored grey are used to help explain how the control measure is used, but they are not a part of the control measure.
<p>Air Detonation</p> <p>Symbol Set Code: 25 Code: 210600</p> <p>Static/Dynamic: S</p>		<p><u>Anchor Points:</u> This symbol requires one anchor point. The center point defines/is the center of the symbol.</p> <p><u>Size/Shape:</u> Static.</p> <p><u>Orientation:</u> The symbol is typically centered over the desired location.</p>	
<p>Ground Zero</p> <p>Symbol Set Code: 25 Code: 210700</p> <p>Static/Dynamic: S</p>		<p><u>Anchor Points:</u> This symbol requires one anchor point. The anchor point defines/is the center of the bottom of the control measure symbol.</p> <p><u>Size/Shape:</u> Static.</p> <p><u>Orientation:</u> The symbol will typically be oriented upright.</p>	
<p>Impact Point</p> <p>Symbol Set Code: 25 Code: 210800</p>		<p><u>Anchor Points:</u> This symbol requires one anchor point. The center point defines/is the center of the symbol.</p> <p><u>Size/Shape:</u></p>	

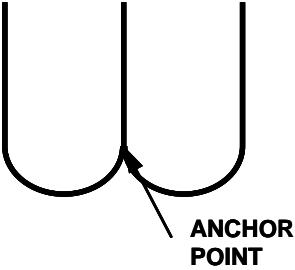
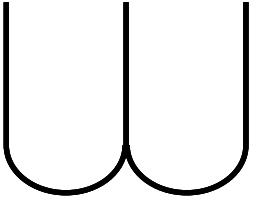
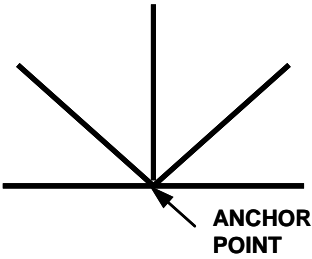
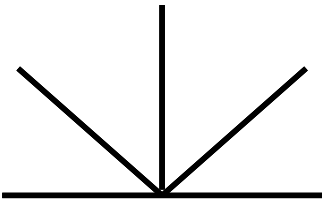
TABLE H-XIV. Maritime control measures - Continued.



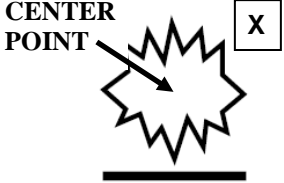

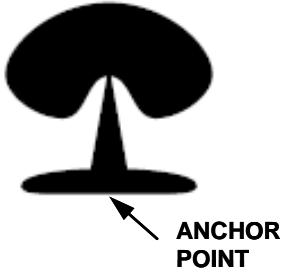
CONTROL MEASURE	TEMPLATE	DRAW RULES	EXAMPLE Note: The symbols that have been colored grey are used to help explain how the control measure is used, but they are not a part of the control measure.
<p>Predicted Impact Point</p> <p>Symbol Set Code: 25 Code: 210900</p>		<p>Static.</p> <p><u>Orientation:</u> The symbol is typically centered over the desired location.</p> <p>Static/Dynamic: S</p>	
<p>Launched Torpedo (AEGIS only)</p> <p>Symbol Set Code: 25 Code: 211000</p>		<p><u>Anchor Points.</u> This symbol requires one anchor point. The anchor point defines the midpoint of the symbol's base.</p>	
<p>Missile Detection Point</p> <p>Symbol Set Code: 25 Code: 211100</p>		<p><u>Size/Shape.</u> Static.</p> <p><u>Orientation.</u> The symbol will typically be oriented upright.</p> <p>Static/Dynamic: S</p>	
<i>Sub-Surface Warfare</i>			
<p>Acoustic Countermeasure (Decoy) (AEGIS only)</p> <p>Symbol Set Code: 25 Code: 211200</p> <p>Static/Dynamic: S</p>		<p><u>Anchor Points.</u> This symbol requires one anchor point. The anchor point defines the midpoint of the symbol's base.</p> <p><u>Size/Shape.</u> Static.</p> <p><u>Orientation.</u> The symbol will typically be oriented upright.</p>	

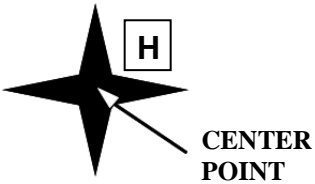
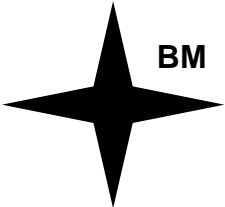
TABLE H-XIV. Maritime control measures - Continued.

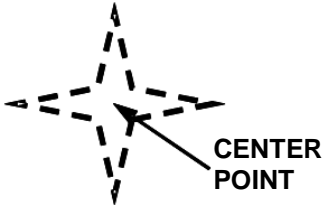
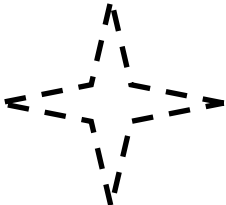
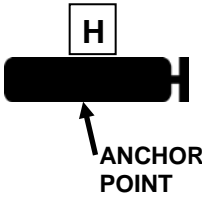

CONTROL MEASURE	TEMPLATE	DRAW RULES	EXAMPLE Note: The symbols that have been colored grey are used to help explain how the control measure is used, but they are not a part of the control measure.
<p>Electronic Countermeasures (ECM) Decoy (AEGIS only)</p> <p>Symbol Set Code: 25 Code: 211300</p> <p>Static/Dynamic: S</p>		<p><u>Anchor Points:</u> This symbol requires one anchor point. The center point defines/is the center of the symbol.</p> <p><u>Size/Shape:</u> Static.</p> <p><u>Orientation:</u> The symbol is typically centered over the desired location.</p>	
<p>Brief Contact</p> <p>Symbol Set Code: 25 Code: 211400</p> <p>Static/Dynamic: S</p>		<p><u>Anchor Points:</u> This symbol requires one anchor point. The anchor point defines the midpoint of the symbol's base.</p> <p><u>Size/Shape:</u> Static.</p> <p><u>Orientation:</u> The symbol will typically be oriented upright.</p>	
<p>Datum Lost Contact</p> <p>Symbol Set Code: 25 Code: 211500</p> <p>Note: The symbol will be oriented as shown in the example to the right and will be centered over the datum.</p> <p>Static/Dynamic: S</p>		<p><u>Anchor Points:</u> This symbol requires one anchor point. The center point defines/is the center of the symbol.</p> <p><u>Size/Shape:</u> Static.</p> <p><u>Orientation:</u> The symbol is typically centered over the desired location.</p>	

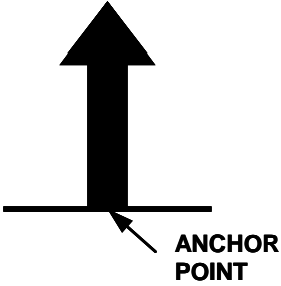
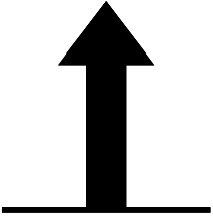
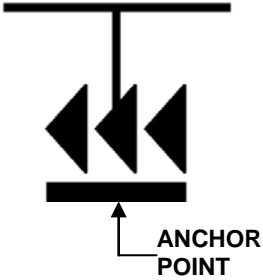
TABLE H-XIV. Maritime control measures - Continued.

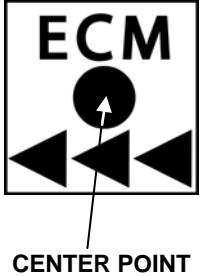

CONTROL MEASURE	TEMPLATE	DRAW RULES	EXAMPLE Note: The symbols that have been colored grey are used to help explain how the control measure is used, but they are not a part of the control measure.
<p>BT Buoy Drop</p> <p>Symbol Set Code: 25 Code: 211600</p> <p>Static/Dynamic: S</p>		<p><u>Anchor Points.</u> This symbol requires one anchor (center) point. The point defines the center of the symbol.</p> <p><u>Size/Shape.</u> Static. The symbol's height should be 2x the symbol's width.</p> <p><u>Orientation.</u> The symbol's center point is typically centered over the desired location. The symbol shall be oriented upright.</p>	
<p>Reported Bottomed Sub</p> <p>Symbol Set Code: 25 Code: 211700</p>		<p><u>Anchor Points:</u> This symbol requires one anchor point. The center point defines/is the center of the symbol.</p> <p><u>Size/Shape:</u> Static.</p> <p><u>Orientation:</u></p>	
<p>Moving Haven</p> <p>Symbol Set Code: 25 Code: 211800</p>		<p>The symbol is typically centered over the desired location.</p> <p>Static/Dynamic: S</p>	

TABLE H-XIV. Maritime control measures - Continued.

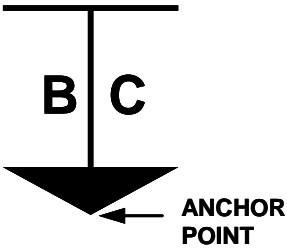
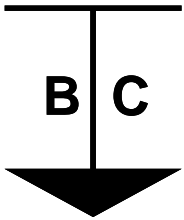
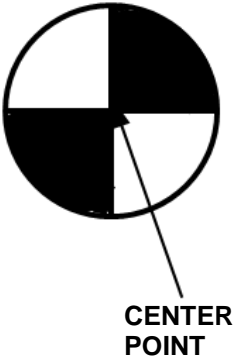
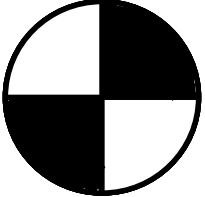



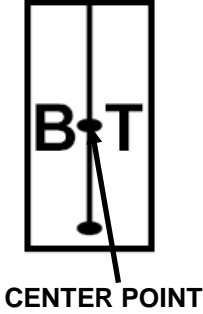

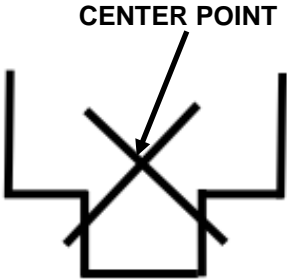
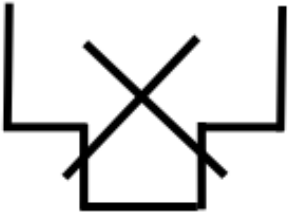
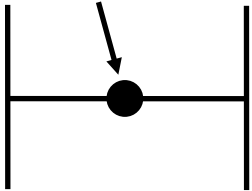
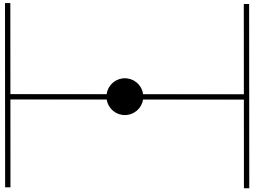
CONTROL MEASURE	TEMPLATE	DRAW RULES	EXAMPLE Note: The symbols that have been colored grey are used to help explain how the control measure is used, but they are not a part of the control measure.
Screen Center Symbol Set Code: 25 Code: 211900			
Lost Contact Symbol Set Code: 25 Code: 212000		<u>Anchor Points.</u> This symbol requires one anchor point. The anchor point defines the midpoint of the symbol's base.	
Sinker Symbol Set Code: 25 Code: 212100		<u>Size/Shape.</u> Static. <u>Orientation.</u> The symbol will typically be oriented upright.	
Trial Track Symbol Set Code: 25 Code: 212200		Static/Dynamic: S	

TABLE H-XIV. Maritime control measures - Continued.

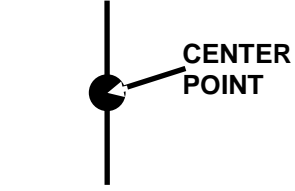

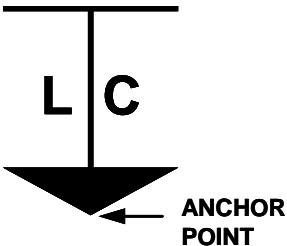
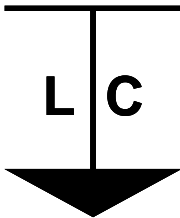
CONTROL MEASURE	TEMPLATE	DRAW RULES	EXAMPLE Note: The symbols that have been colored grey are used to help explain how the control measure is used, but they are not a part of the control measure.
<i>Fix</i>			
Acoustic Fix Symbol Set Code: 25 Code: 212300		<u>Anchor Points:</u> This symbol requires one anchor point. The center point defines/is the center of the symbol. <u>Size/Shape:</u> Static. <u>Orientation:</u> The symbol is typically centered over the desired location.	
Electromagnetic Fix Symbol Set Code: 25 Code: 212400		Static/Dynamic: S	
Electromagnetic - Magnetic Anomaly Detection (MAD) Symbol Set Code: 25 Code: 212500			

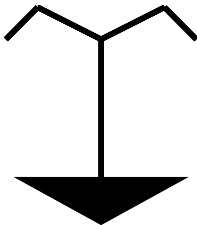
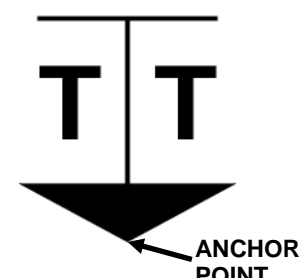
TABLE H-XIV. Maritime control measures - Continued.

CONTROL MEASURE	TEMPLATE		DRAW RULES	EXAMPLE Note: The symbols that have been colored grey are used to help explain how the control measure is used, but they are not a part of the control measure.
Optical Fix Symbol Set Code: 25 Code: 212600				
Formation Symbol Set Code: 25 Code: 212700				
Harbor Symbol Set Code: 25 Code: 212800	 <p data-bbox="412 1423 805 1633">Note: Normally, the H field has four possible entries as shown in the harbor entrance point entry below. However, a user can use this symbol to define a new type of point if the preceding selections are not sufficient.</p>		<p data-bbox="829 1157 1008 1388"><u>Anchor Points.</u> This symbol requires one anchor point. The center point defines the center of the symbol.</p> <p data-bbox="829 1398 992 1577"><u>Size/Shape.</u> Static. The symbol's corners form a 70-degree angle.</p> <p data-bbox="829 1587 984 1755"><u>Orientation.</u> The symbol is typically centered over the desired location.</p>	
Harbor Entrance Point Symbol Set Code: 25 Code: 212900	<p data-bbox="492 1703 516 1724">A</p> <p data-bbox="412 1766 565 1787">Code: 212901</p>	<p data-bbox="703 1703 727 1724">Q</p> <p data-bbox="621 1766 774 1787">Code: 212902</p>	<p data-bbox="829 1797 1003 1850">Static/Dynamic: S</p>	<p data-bbox="1032 1671 1414 1724">Must be used in conjunction with the harbor control measure symbol.</p>

TABLE H-XIV. Maritime control measures - Continued.

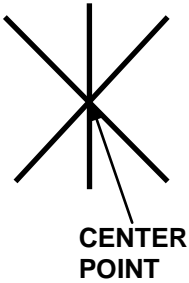
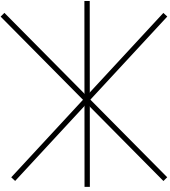
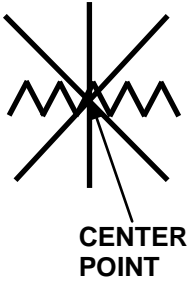
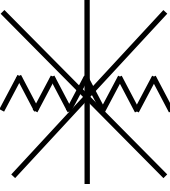
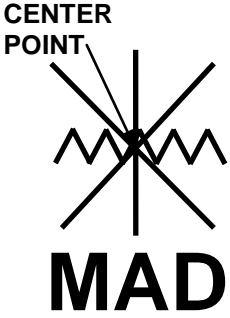
CONTROL MEASURE	TEMPLATE		DRAW RULES	EXAMPLE <i>Note:</i> The symbols that have been colored grey are used to help explain how the control measure is used, but they are not a part of the control measure.
	X Code: 212903	Y Code: 212904		
<i>Search</i>				
Dip Position Symbol Set Code: 25 Code: 213000			<u>Anchor Points.</u> This symbol requires one anchor point. The center point defines/is the center of the symbol. <u>Size/Shape.</u> Static.	
Search Symbol Set Code: 25 Code: 213100			<u>Orientation.</u> The symbol is typically centered over the desired location. Static/Dynamic: S	
Search Area Symbol Set Code: 25 Code: 213200				
Search Center Symbol Set Code: 25 Code: 213300				

TABLE H-XIV. Maritime control measures - Continued.

CONTROL MEASURE	TEMPLATE	DRAW RULES	EXAMPLE Note: The symbols that have been colored grey are used to help explain how the control measure is used, but they are not a part of the control measure.
Navigational Reference Point Symbol Set Code: 25 Code: 213400			
<i>Sonobuoys</i>			
Sonobuoy Symbol Set Code: 25 Code: 213500		<u>Anchor Points.</u> This symbol requires one anchor point. The point defines the center of the circle.	
Ambient Noise Sonobuoy Symbol Set Code: 25 Code: 213501		<u>Size/Shape.</u> Static. The diameter of the circle should be 1/2 the height of the symbol. <u>Orientation.</u> The symbol's center point is typically centered over the desired location. The symbol shall be oriented upright.	
Air Transportable Communication (ATAC) Symbol Set Code: 25 Code: 213502		Static/Dynamic: S	
Barra Symbol Set Code: 25 Code: 213503			

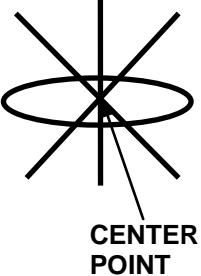
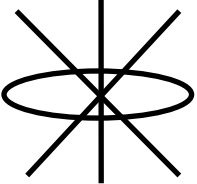
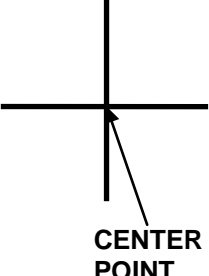
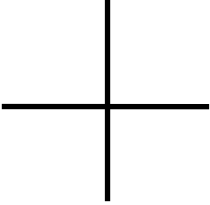
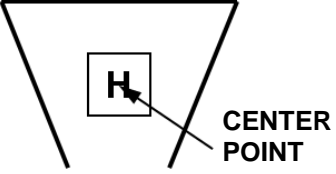
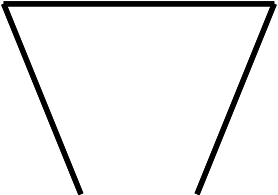
TABLE H-XIV. Maritime control measures - Continued.

CONTROL MEASURE	TEMPLATE	DRAW RULES	EXAMPLE Note: The symbols that have been colored grey are used to help explain how the control measure is used, but they are not a part of the control measure.
<p>Bathythermograph Transmitting Sonobuoy (BT)</p> <p>Symbol Set Code: 25 Code: 213504</p>			
<p>Command Active Multi-Beam Sonobuoy (CAMBS)</p> <p>Symbol Set Code: 25 Code: 213505</p>			
<p>Command Active Sonobuoy Directional Command Active Sonobuoy System (CASS)</p> <p>Symbol Set Code: 25 Code: 213506</p>			
<p>Directional Frequency Analyzing and Recording (DIFAR)</p> <p>Symbol Set Code: 25 Code: 213507</p>			
<p>Directional Command Active Sonobuoy System (DICASS)</p> <p>Symbol Set Code: 25 Code: 213508</p>			

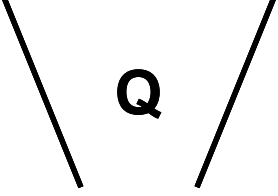
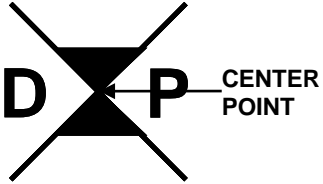
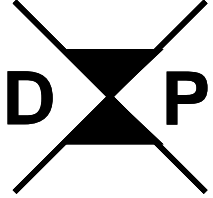
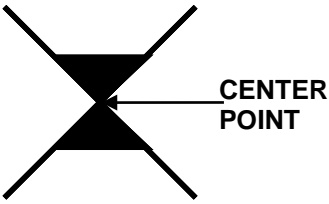
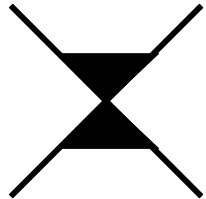
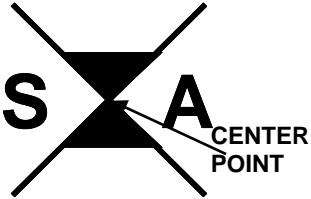
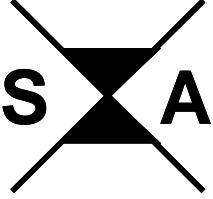
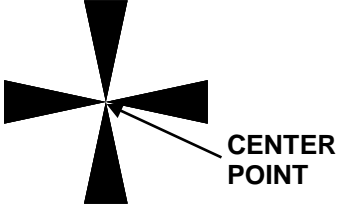
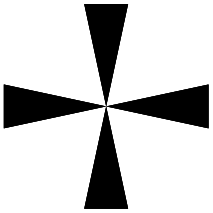
TABLE H-XIV. Maritime control measures - Continued.

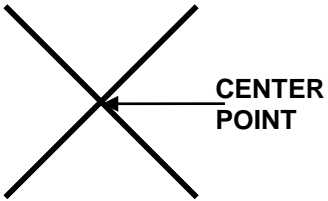
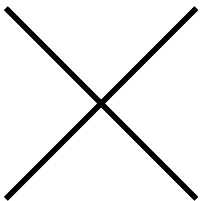
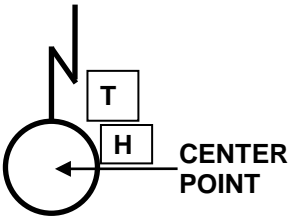
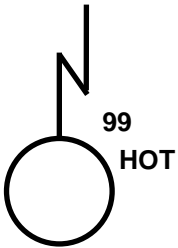
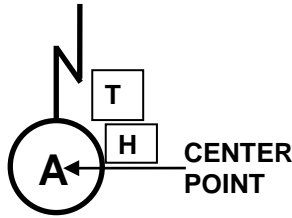
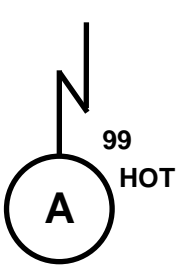
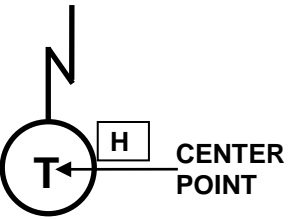
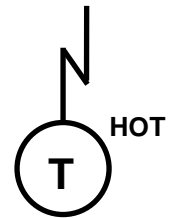
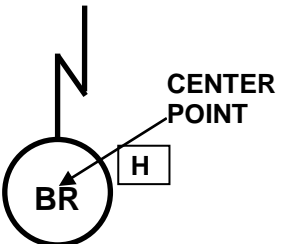
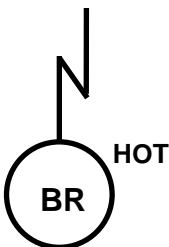

CONTROL MEASURE	TEMPLATE	DRAW RULES	EXAMPLE Note: The symbols that have been colored grey are used to help explain how the control measure is used, but they are not a part of the control measure.
<p>Expendable Reliable Acoustic Path Sonobuoy (ERAPS)</p> <p>Symbol Set Code: 25 Code: 213509</p>			
<p>Expired Sonobuoy</p> <p>Symbol Set Code: 25 Code: 213510</p>			
<p>Kingpin Sonobuoy</p> <p>Symbol Set Code: 25 Code: 213511</p>			
<p>Low Frequency Analyzing and Recording Sonobuoy (LOFAR)</p> <p>Symbol Set Code: 25 Code: 213512</p>			
<p>Pattern Center Sonobuoy</p> <p>Symbol Set Code: 25 Code: 213513</p>			

TABLE H-XIV. Maritime control measures - Continued.

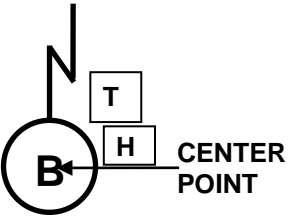
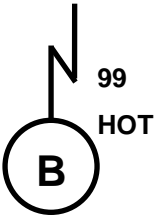
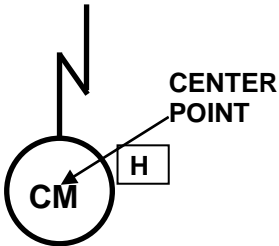
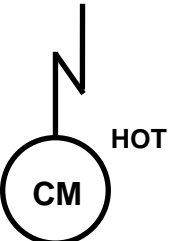
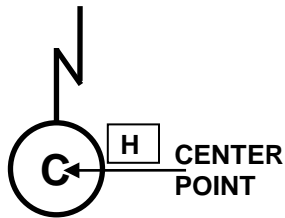
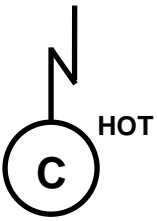
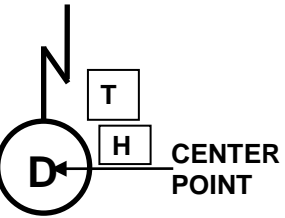
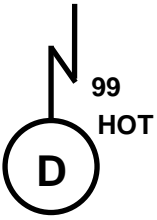
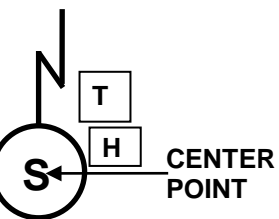
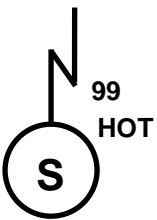
CONTROL MEASURE	TEMPLATE	DRAW RULES	EXAMPLE Note: The symbols that have been colored grey are used to help explain how the control measure is used, but they are not a part of the control measure.
Range Only Sonobuoy Symbol Set Code: 25 Code: 213514			
Vertical Line Array Directional Frequency Analysis and Recording (DIFAR) Sonobuoy Symbol Set Code: 25 Code: 213515			
<i>Reference Points</i>			
Reference Point Symbol Set Code: 25 Code: 213600		<u>Anchor Points.</u> This symbol requires one anchor point. The center point defines/is the center of the symbol.	
Special Point Symbol Set Code: 25 Code: 213700		<u>Size/Shape.</u> Static. <u>Orientation.</u> The symbol is typically centered over the desired location.	

TABLE H-XIV. Maritime control measures - Continued.

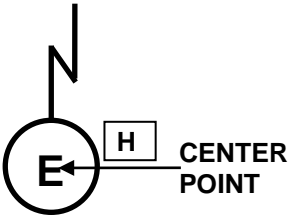
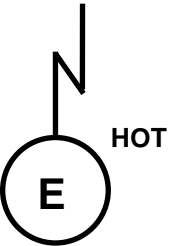
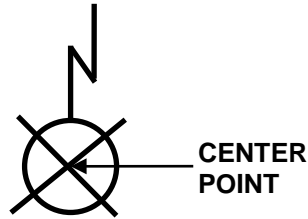
CONTROL MEASURE	TEMPLATE	DRAW RULES	EXAMPLE <i>Note:</i> The symbols that have been colored grey are used to help explain how the control measure is used, but they are not a part of the control measure.
Navigational Reference Point Symbol Set Code: 25 Code: 213800		Static/Dynamic: S	
Data Link Reference Point Symbol Set Code: 25 Code: 213900			
Forward Observer / Spotter Position Symbol Set Code: 25 Code: 214000			
Vital Area Center Symbol Set Code: 25 Code: 214100			
Corridor Tab Point Symbol Set Code: 25 Code: 214200			

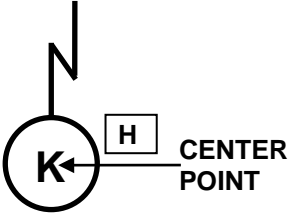
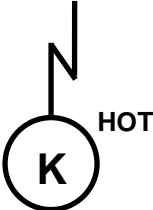
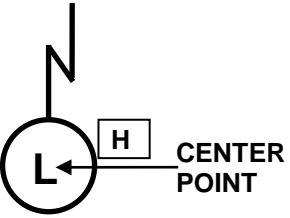
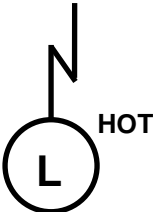
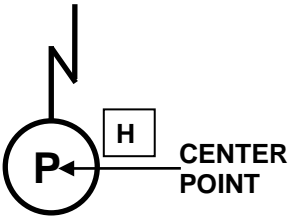
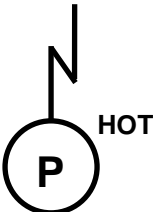
TABLE H-XIV. Maritime control measures - Continued.

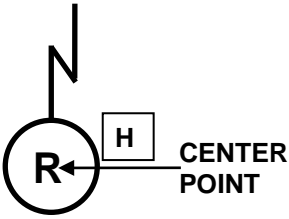
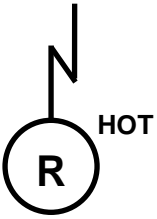
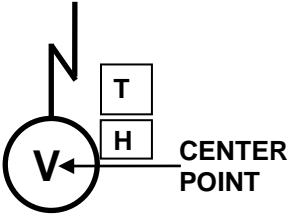
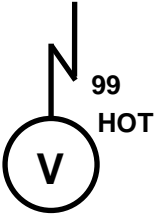
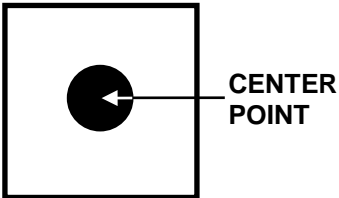
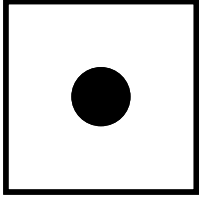
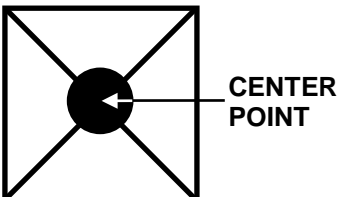
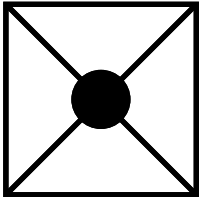

CONTROL MEASURE	TEMPLATE	DRAW RULES	EXAMPLE Note: The symbols that have been colored grey are used to help explain how the control measure is used, but they are not a part of the control measure.
Enemy Point Symbol Set Code: 25 Code: 214300			
Marshall Point Symbol Set Code: 25 Code: 214400			
Position and Intended Movement (PIM) Symbol Set Code: 25 Code: 214500			
Pre-Landfall Waypoint Symbol Set Code: 25 Code: 214600			
Estimated Position (EP) Symbol Set Code: 25 Code: 214700			

TABLE H-XIV. Maritime control measures - Continued.

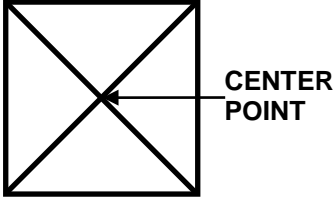
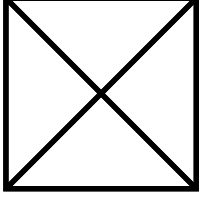
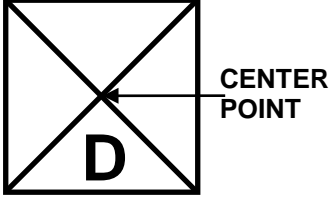
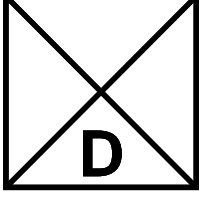
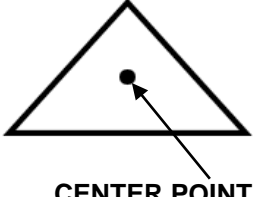
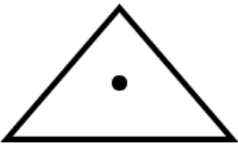
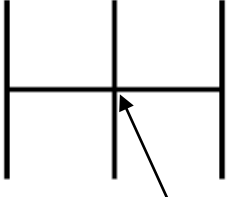
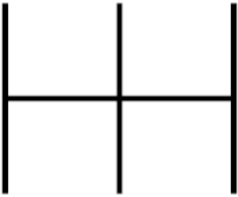
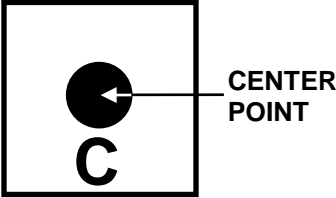
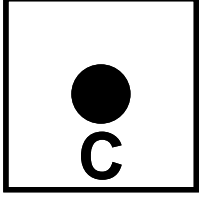
CONTROL MEASURE	TEMPLATE	DRAW RULES	EXAMPLE Note: The symbols that have been colored grey are used to help explain how the control measure is used, but they are not a part of the control measure.
Waypoint Symbol Set Code: 25 Code: 214800			
<i>Subsurface Stations</i>			
General Subsurface Station Symbol Set Code: 25 Code: 214900		<u>Anchor Points.</u> This symbol requires one anchor point. The center point defines/is the center of the symbol. <u>Size/Shape.</u> Static.	
Submarine Subsurface Station Symbol Set Code: 25 Code: 215000		<u>Orientation.</u> The symbol is typically centered over the desired location. Static/Dynamic: S	
Submarine Antisubmarine Warfare Subsurface Station Symbol Set Code: 25 Code: 215100			

TABLE H-XIV. Maritime control measures - Continued.

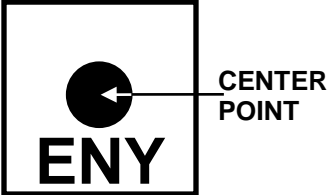

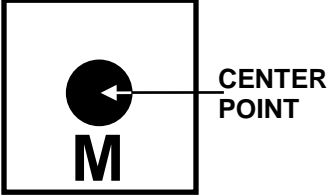
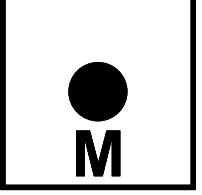
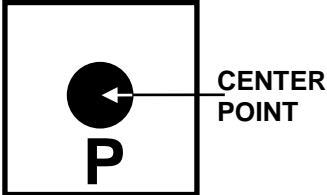
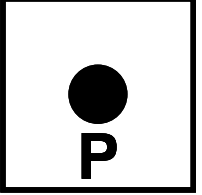
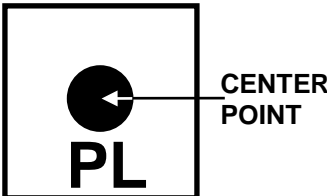
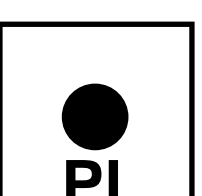
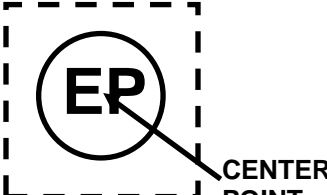
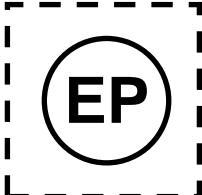

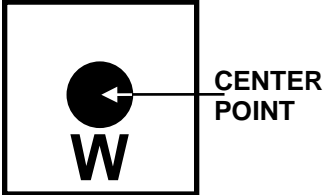
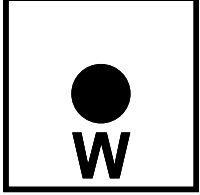
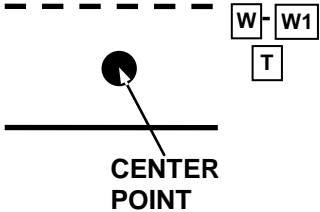
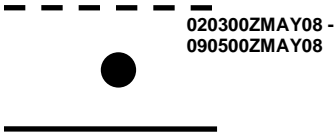
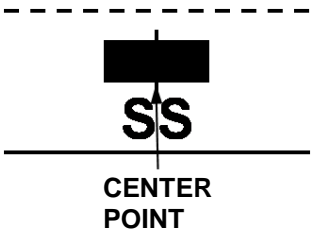
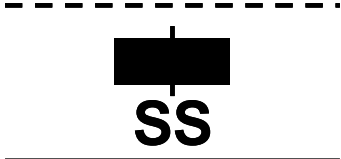
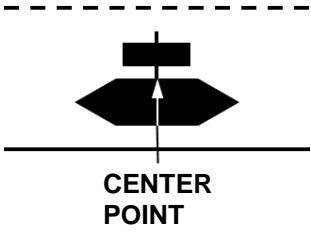
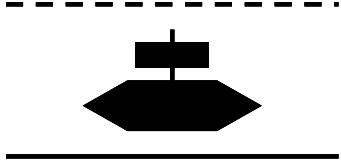

CONTROL MEASURE	TEMPLATE	DRAW RULES	EXAMPLE Note: The symbols that have been colored grey are used to help explain how the control measure is used, but they are not a part of the control measure.
Unmanned Underwater Vehicle Subsurface Station Symbol Set Code: 25 Code: 215200			
Antisubmarine Warfare (ASW) Unmanned Underwater Vehicle Subsurface Station Symbol Set Code: 25 Code: 215300			
Mine Warfare Unmanned Underwater Vehicle Subsurface Station Symbol Set Code: 25 Code: 215400			
Surface Warfare Unmanned Underwater Vehicle Subsurface Station Symbol Set Code: 25 Code: 215500			

TABLE H-XIV. Maritime control measures - Continued.

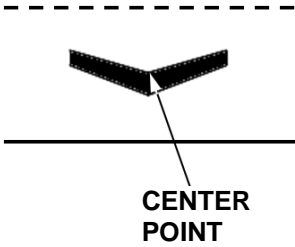
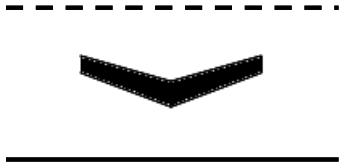
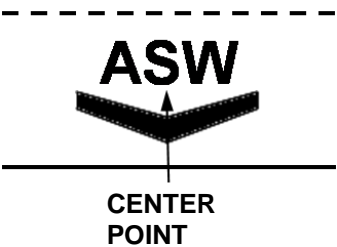

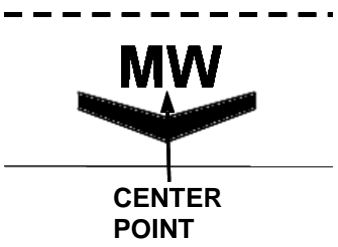

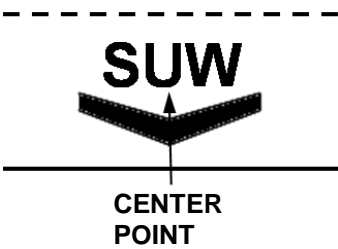



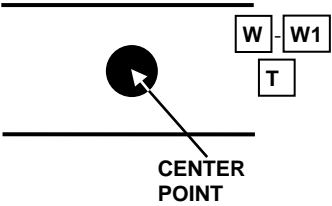
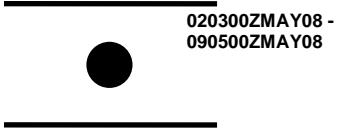
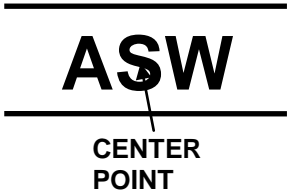

CONTROL MEASURE	TEMPLATE	DRAW RULES	EXAMPLE Note: The symbols that have been colored grey are used to help explain how the control measure is used, but they are not a part of the control measure.
<i>Surface Stations</i>			
General Surface Station Symbol Set Code: 25 Code: 215600		<u>Anchor Points.</u> This symbol requires one anchor point. The center point defines/is the center of the symbol. <u>Size/Shape.</u> Static.	
Antisubmarine Warfare (ASW) Surface Station Symbol Set Code: 25 Code: 215700		<u>Orientation.</u> The symbol is typically centered over the desired location.	
Mine Warfare Surface Station Symbol Set Code: 25 Code: 215800		Static/Dynamic: S	
Non-Combatant Surface Station Symbol Set Code: 25 Code: 215900			
Picket Surface Station Symbol Set Code: 25 Code: 216000			
Rendezvous Surface Station Symbol Set Code: 25 Code: 216100			

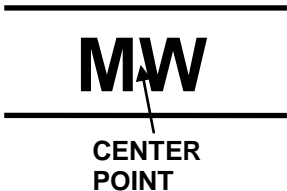
TABLE H-XIV. Maritime control measures - Continued.

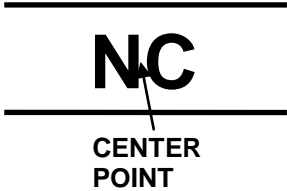

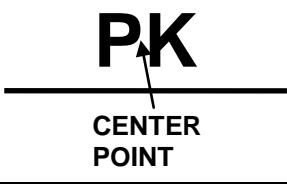





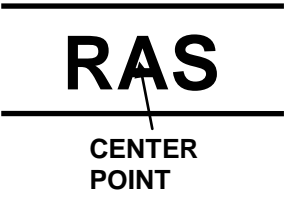

CONTROL MEASURE	TEMPLATE	DRAW RULES	EXAMPLE Note: The symbols that have been colored grey are used to help explain how the control measure is used, but they are not a part of the control measure.
Replenishment at Sea Surface Station Symbol Set Code: 25 Code: 216200			
Rescue Surface Station Symbol Set Code: 25 Code: 216300			
Surface Warfare Surface Station Symbol Set Code: 25 Code: 216400			
Unmanned Underwater Vehicle Surface Station Symbol Set Code: 25 Code: 216500			
Antisubmarine Warfare (ASW) Unmanned Underwater Vehicle Surface Station Symbol Set Code: 25 Code: 216600			

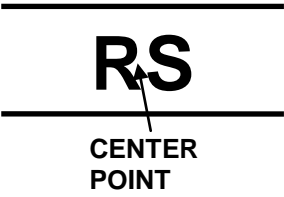
TABLE H-XIV. Maritime control measures - Continued.

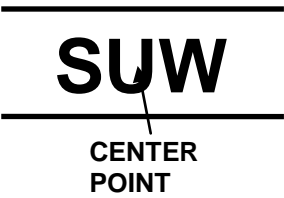

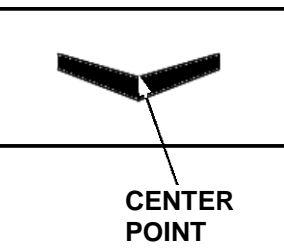

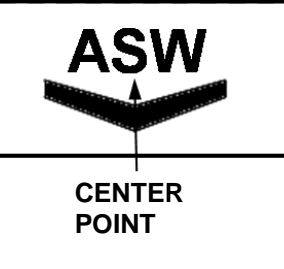

CONTROL MEASURE	TEMPLATE	DRAW RULES	EXAMPLE <i>Note:</i> The symbols that have been colored grey are used to help explain how the control measure is used, but they are not a part of the control measure.
Mine Warfare Unmanned Underwater Vehicle Surface Station Symbol Set Code: 25 Code: 216700			
Remote Multi-Mission Vehicle Unmanned Underwater Vehicle Surface Station Symbol Set Code: 25 Code: 216800			
Surface Warfare Unmanned Underwater Vehicle Surface Station Symbol Set Code: 25 Code: 216900			
Shore Control Station Symbol Set Code: 25 Code: 217000			
<i>Routes</i>			
General Route Symbol Set Code: 25 Code: 217100		<u>Anchor Points.</u> This symbol requires one anchor point. The center point defines/is the center of the symbol.	

TABLE H-XIV. Maritime control measures - Continued.

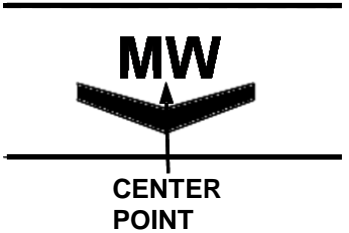
CONTROL MEASURE	TEMPLATE	DRAW RULES	EXAMPLE Note: The symbols that have been colored grey are used to help explain how the control measure is used, but they are not a part of the control measure.
Diversion Route Symbol Set Code: 25 Code: 217200		<u>Size/Shape.</u> Static. <u>Orientation.</u> The symbol is typically centered over the desired location. Static/Dynamic: S	
Position and Intended Movement (PIM) Route Symbol Set Code: 25 Code: 217300			
Picket Route Symbol Set Code: 25 Code: 217400			
Point R Route Symbol Set Code: 25 Code: 217500			

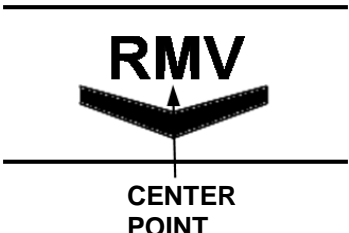
TABLE H-XIV. Maritime control measures - Continued.

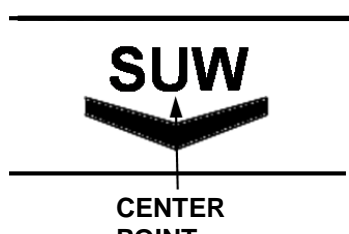
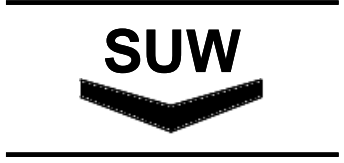
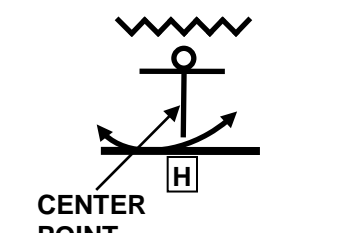
CONTROL MEASURE	TEMPLATE	DRAW RULES	EXAMPLE Note: The symbols that have been colored grey are used to help explain how the control measure is used, but they are not a part of the control measure.
<p>Rendezvous Route</p> <p>Symbol Set Code: 25 Code: 217600</p>	<p>CENTER POINT</p>  <p>RZ</p>		 <p>RZ</p>
<p>Waypoint Route</p> <p>Symbol Set Code: 25 Code: 217700</p>	<p>CENTER POINT</p>  <p>W</p>		 <p>W</p>
<p>Clutter, Stationary or Cease Reporting</p> <p>Symbol Set Code: 25 Code: 217800</p>	<p>CENTER POINT</p> 		
<p>Tentative or Provisional Track</p> <p>Symbol Set Code: 25 Code: 217900</p>	<p>CENTER POINT</p> 		

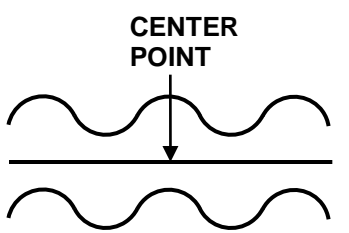
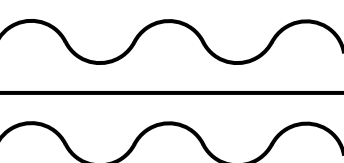
TABLE H-XIV. Maritime control measures - Continued.

CONTROL MEASURE	TEMPLATE	DRAW RULES	EXAMPLE <i>Note:</i> The symbols that have been colored grey are used to help explain how the control measure is used, but they are not a part of the control measure.
<i>Emergency</i>			
<p>Distressed Vessel</p> <p>Symbol Set Code: 25 Code: 218000</p>		<p><u>Anchor Points.</u> This symbol requires one anchor point. The anchor point defines the midpoint of the symbol's base. <u>Size/Shape.</u> Static.</p>	
<p>Ditched Aircraft/Downed Aircraft</p> <p>Symbol Set Code: 25 Code: 218100</p>		<p><u>Orientation.</u> The symbol will typically be oriented upright.</p> <p>Static/Dynamic: S</p>	
<p>Person In Water/Bailout</p> <p>Symbol Set Code: 25 Code: 218200</p>			

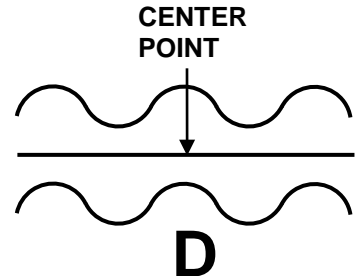
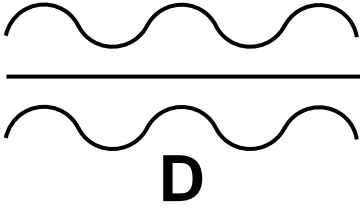
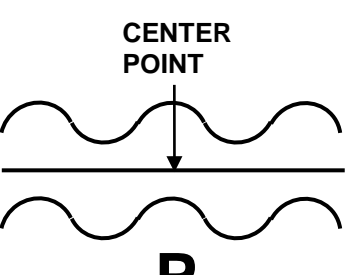
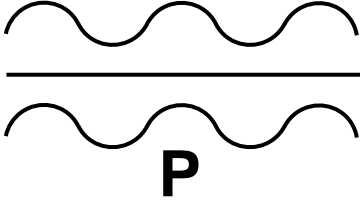
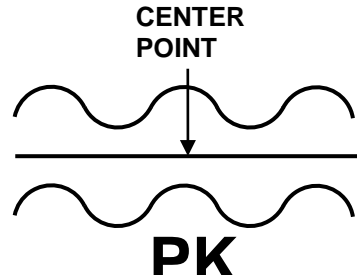
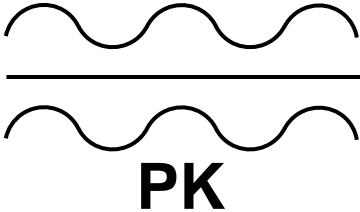
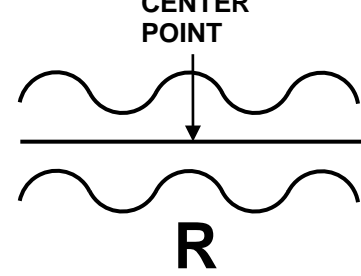
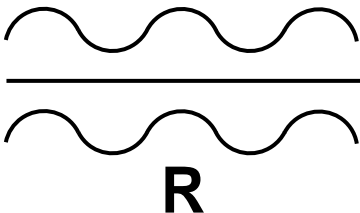
TABLE H-XIV. Maritime control measures - Continued.

CONTROL MEASURE	TEMPLATE	DRAW RULES	EXAMPLE Note: The symbols that have been colored grey are used to help explain how the control measure is used, but they are not a part of the control measure.
<i>Hazard</i>			
<p>Iceberg</p> <p>Symbol Set Code: 25 Code: 218300</p> <p>Static/Dynamic: S</p>		<p><u>Anchor Points.</u> This symbol requires one anchor point. The center point defines/is the center of the symbol.</p> <p><u>Size/Shape.</u> Static.</p> <p><u>Orientation.</u> The symbol is typically centered over the desired location.</p>	
<p>Navigational</p> <p>Symbol Set Code: 25 Code: 218400</p> <p>Static/Dynamic: D</p>		<p><u>Anchor Points.</u> This symbol requires two anchor points. Points 1 and 2 define the corner points of the symbol.</p> <p><u>Size/Shape.</u> The symbol varies only in length.</p> <p><u>Orientation.</u> Orientation is determined by the anchor points.</p>	
<p>Oil Rig</p> <p>Symbol Set Code: 25 Code: 218500</p>		<p><u>Anchor Points.</u> This symbol requires one anchor point. The center point defines/is the center of the symbol.</p> <p><u>Size/Shape.</u> Static.</p> <p><u>Orientation.</u></p>	

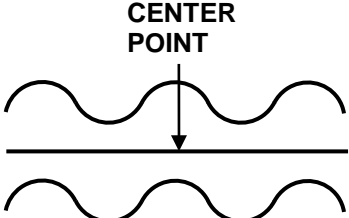
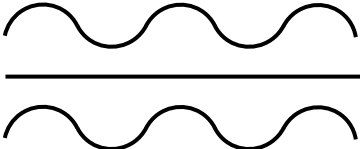
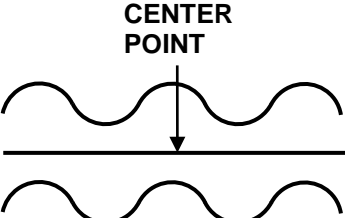
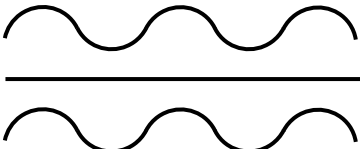
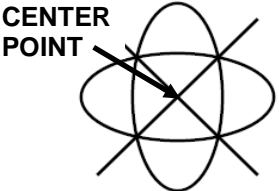
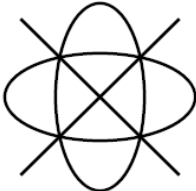
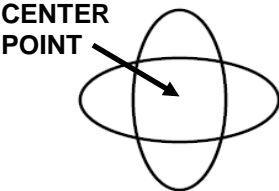
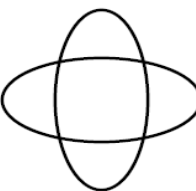
TABLE H-XIV. Maritime control measures - Continued.

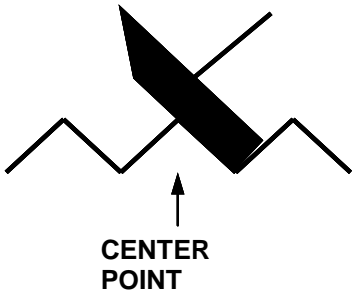
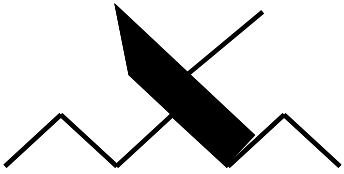
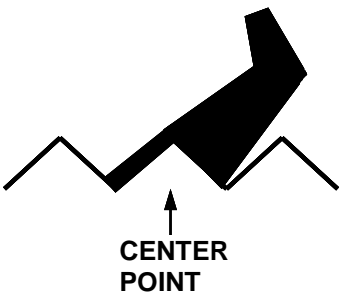
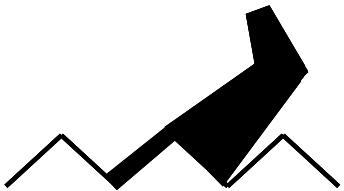
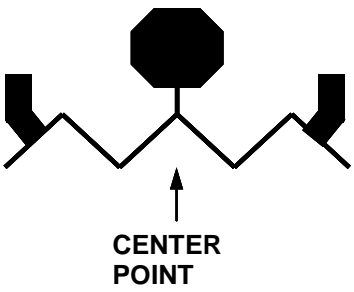
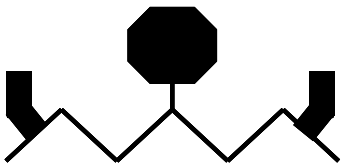

CONTROL MEASURE	TEMPLATE	DRAW RULES	EXAMPLE Note: The symbols that have been colored grey are used to help explain how the control measure is used, but they are not a part of the control measure.
<p>Sea Mine-Like</p> <p>Symbol Set Code: 25 Code: 218600</p> <p>Note: The orientation of symbol can be rotated in 90 degree increments.</p>		<p>The symbol is typically centered over the desired location.</p> <p>Static/Dynamic: S</p>	
<i>Sea Subsurface Returns</i>			
<p>Bottom Return/ Non-Mine, Mine-Like Bottom Object (NOMBO)</p> <p>Symbol Set Code: 25 Code: 218700</p>		<p><u>Anchor Points.</u> This symbol requires one anchor point. The anchor point defines the midpoint of the symbol's base.</p> <p><u>Size/Shape.</u> Static.</p> <p><u>Orientation.</u></p>	
<p>Bottom Return/ Non-Mine, Mine-Like Bottom Object (NOMBO)/ Installation/ Manmade</p> <p>Symbol Set Code: 25 Code: 218800</p>		<p>The symbol will typically be oriented upright.</p> <p>Static/Dynamic: S</p>	

TABLE H-XIV. Maritime control measures - Continued.

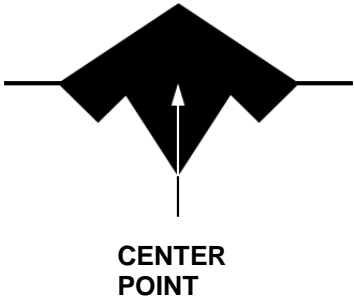
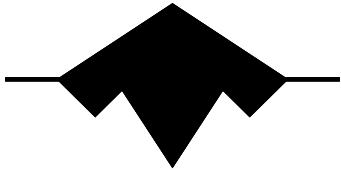
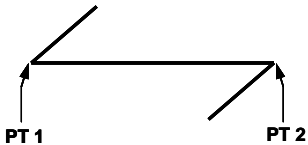
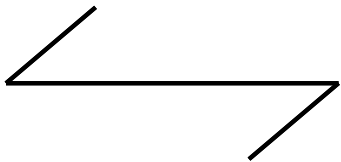
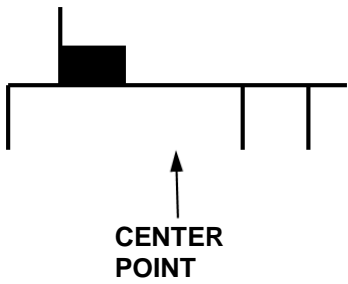
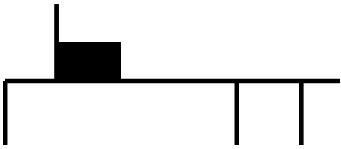

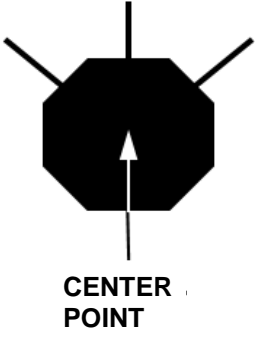
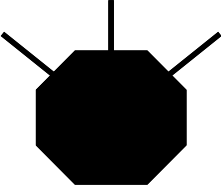
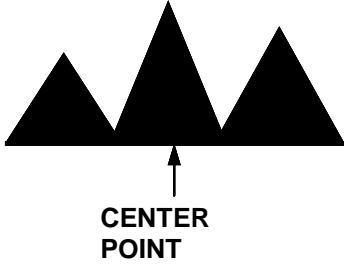

CONTROL MEASURE	TEMPLATE	DRAW RULES	EXAMPLE Note: The symbols that have been colored grey are used to help explain how the control measure is used, but they are not a part of the control measure.
<p>Marine Life</p> <p>Symbol Set Code: 25 Code: 218900</p> <p>Static/Dynamic: S</p>		<p><u>Anchor Points.</u> This graphic requires one anchor point. The anchor point defines “nose” of the graphic. <u>Size/Shape.</u> Static. <u>Orientation.</u> The graphic is typically centered over the desired location</p>	
<p>Sea Anomaly (Wake, Current, Knuckle)</p> <p>Symbol Set Code: 25 Code: 219000</p>		<p><u>Anchor Points.</u> This graphic requires one anchor point. The center point defines/is the center of the graphic. <u>Size/Shape.</u> Static. <u>Orientation.</u> The graphic’s center point is typically centered over the desired location.</p>	
<p>Bottom Return/Non-MILCO, Wreck, Dangerous</p> <p>Symbol Set Code: 25 Code: 219100</p>		<p>Static/Dynamic: S</p>	

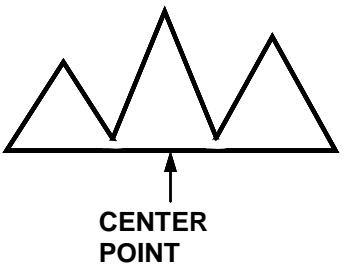
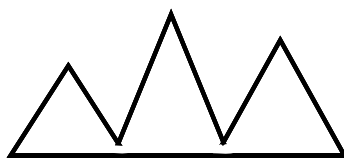
TABLE H-XIV. Maritime control measures - Continued.

CONTROL MEASURE	TEMPLATE	DRAW RULES	EXAMPLE Note: The symbols that have been colored grey are used to help explain how the control measure is used, but they are not a part of the control measure.
<p>Bottom Return/Non-MILCO, Wreck, Non Dangerous</p> <p>Symbol Set Code: 25 Code: 219200</p>			
<p>Maritime Control Lines</p> <p>Symbol Set Code: 25 Code: 220000</p>	<p>N/A</p>		<p>N/A</p>
<p>Bearing Line</p> <p>Symbol Set Code: 25 Code: 220100</p>		<p><u>Anchor Points.</u> This graphic requires two anchor points. Points 1 and 2 define the endpoints of the symbol. <u>Size/Shape.</u> The symbol varies only in length.</p>	
<p>Bearing Line, Electronic</p> <p>Symbol Set Code: 25 Code: 220101</p>		<p><u>Orientation.</u> One point defines the origin from which the bearing is being taken and the other point defines the location or</p>	

TABLE H-XIV. Maritime control measures - Continued.

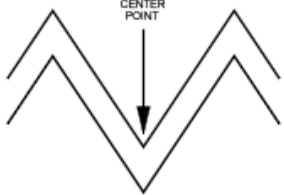
CONTROL MEASURE	TEMPLATE	DRAW RULES	EXAMPLE Note: The symbols that have been colored grey are used to help explain how the control measure is used, but they are not a part of the control measure.
<p>Bearing Line, Electronic Warfare</p> <p>Symbol Set Code: 25 Code: 220102</p>		<p>direction from which a contact is made.</p> <p>Static/Dynamic: D</p>	 <p>Note: "H" field may contain the following identifiers:</p> <ul style="list-style-type: none"> •"MSL" – missile •"MCU" – missile control unit •"TENT" - tentative
<p>Bearing Line, Acoustic</p> <p>Symbol Set Code: 25 Code: 220103</p>			 <p>Note: "H" field may contain the following identifiers:</p> <ul style="list-style-type: none"> •"L3-ACT" – LAMPS, active •"L3-pHELO" – LAMPS, Helicopter, passive •"L3-pSHIP" – LAMPS, Ship, passive •"L3-OSC" – LAMPS, Operator Specified Contact, passive •"L3-ATT" – LAMPS, Acoustic Target Track, passive

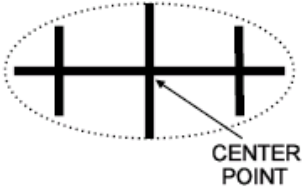
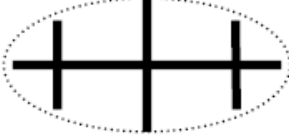
TABLE H-XIV. Maritime control measures - Continued.

CONTROL MEASURE	TEMPLATE	DRAW RULES	EXAMPLE Note: The symbols that have been colored grey are used to help explain how the control measure is used, but they are not a part of the control measure.
<p>Bearing Line, Acoustic (Ambiguous)</p> <p>Symbol Set Code: 25 Code: 220104</p>			 <p>Note: "H" field may contain the following identifiers:</p> <ul style="list-style-type: none"> •"L3-ACT" – LAMPS, active •"L3-pHELO" – LAMPS, Helicopter, passive •"L3-pSHIP" – LAMPS, Ship, passive •"L3-OSC" – LAMPS, Operator Specified Contact, passive •"L3-ATT" – LAMPS, Acoustic Target Track, passive
<p>Bearing Line, Torpedo</p> <p>Symbol Set Code: 25 Code: 220105</p>			
<p>Bearing Line, Electro-Optical Intercept</p> <p>Symbol Set Code: 25 Code: 220106</p>			

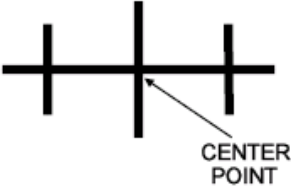
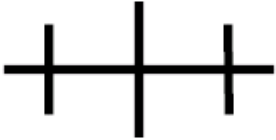
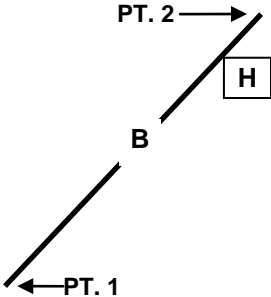
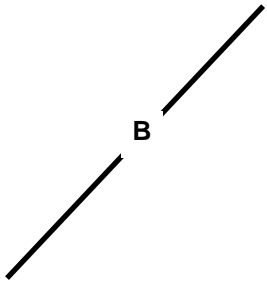
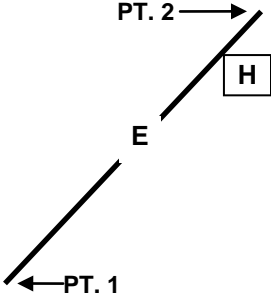
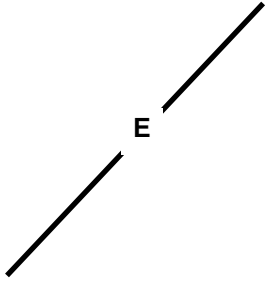
TABLE H-XIV. Maritime control measures - Continued.

CONTROL MEASURE	TEMPLATE	DRAW RULES	EXAMPLE Note: The symbols that have been colored grey are used to help explain how the control measure is used, but they are not a part of the control measure.
<p>Bearing Line, Jammer</p> <p>Symbol Set Code: 25 Code: 220107</p> <p>Note: "H" field may contain the following: •"PAT-1" – PAT-1 Jammer</p>			 <p>Note: "H" field may only contain the "PAT-1" – PAT-1 Jammer</p>
<p>Bearing Line, Radio Detection Finder (RDF)</p> <p>Symbol Set Code: 25 Code: 220108</p> <p>Static/Dynamic: D</p>			

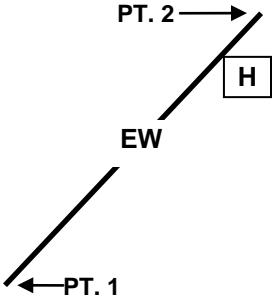
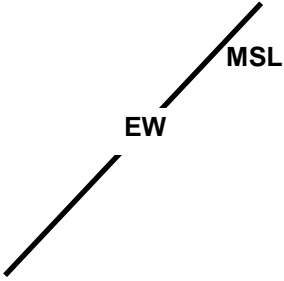
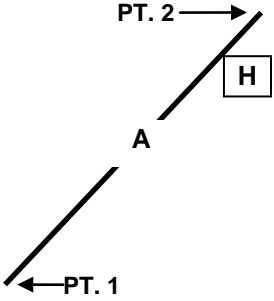
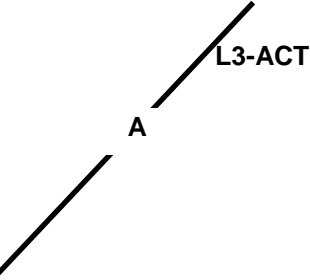
H.5.17 Deception control measures.

H.5.17.1 Deception control measures. Are designed to mislead the enemy by manipulation, distortion, or falsification of evidence to induce him to react in a manner prejudicial to his interests.

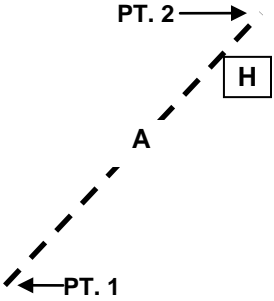
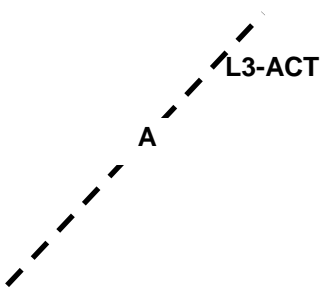
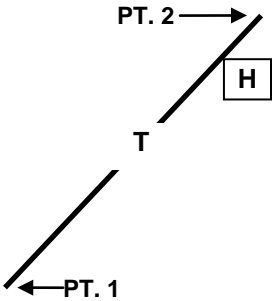
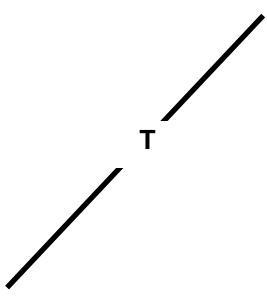
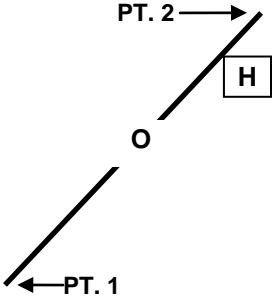
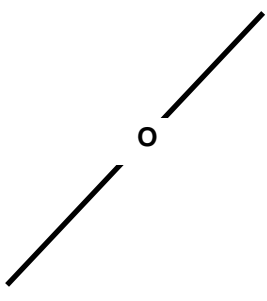
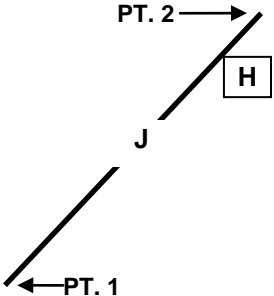
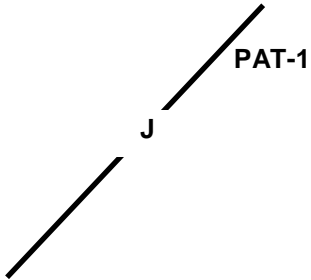
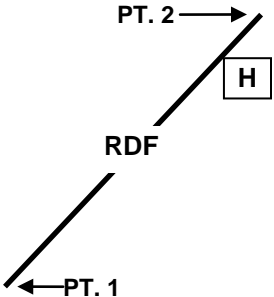
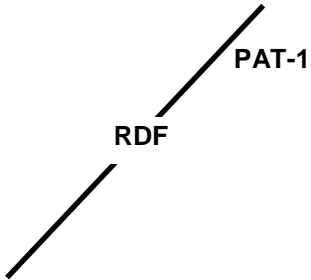
TABLE H-XV. Deception control measure symbols.

CONTROL MEASURE	TEMPLATE	DRAW RULES	EXAMPLE Note: The symbols that have been colored grey are used to help explain how the control measure is used, but they are not a part of the control measure.
<p>Deception</p> <p>Symbol Set Code: 25 Code: 230000</p>	<p>N/A</p>		<p>N/A</p>

TABLE H-XV. Deception control measure symbols - Continued.

CONTROL MEASURE	TEMPLATE	DRAW RULES	EXAMPLE Note: The symbols that have been colored grey are used to help explain how the control measure is used, but they are not a part of the control measure.
<p>Decoy/Dummy</p> <p>An imitation of a person, object or phenomenon, which is intended to deceive hostile surveillance or detection systems or mislead the adversary.</p> <p>Symbol Set Code: 25 Code: 230100</p>		<p><u>Anchor Points.</u> This symbol requires 3 anchor points. Point 1 defines the vertex of the symbol and points 2 and 3 define its endpoints.</p> <p><u>Size/Shape.</u> Points 1, 2 and 3 determine the length of the lines connecting them. The line defined by points 1 and 2 is typically the same length as the line between points 2 and 3.</p> <p><u>Orientation.</u> Orientation is determined by the anchor points.</p>	

TABLE H-XV. Deception control measure symbols - Continued.

CONTROL MEASURE	TEMPLATE	DRAW RULES	EXAMPLE Note: The symbols that have been colored grey are used to help explain how the control measure is used, but they are not a part of the control measure.
<p>Decoy/Dummy and Feint</p> <p>In military deception, an offensive action involving contact with the adversary conducted for the purpose of deceiving the adversary as to the location and/or time of the actual main offensive action.</p> <p>Symbol Set Code: 25 Code: 230200</p>		<p><u>Note:</u> Anchor points are determined by the relationship between the control measure symbol being modified and the decoy/dummy or feint control measure symbol modifying it. See the specific control measure being modified for anchor points.</p> <p>Static/Dynamic: D</p>	
<p>Axis of Advance for a Feint</p>	<p><u>See Axis of Advance under Maneuver Control Measures</u></p>		
<p>Direction of Attack for a Feint</p>	<p><u>See Direction of Attack under Maneuver Control Measures</u></p>		
<p>Decoy Mined Area</p>	<p><u>See Decoy Mined Area under Obstacles</u></p>		
<p>Dummy Minefield</p>	<p><u>See Decoy Mined Area under Obstacles</u></p>		

H.5.18 Fire Support Coordination Measures.

H.5.18.1 Fire Support Coordination Measures. Measures employed by land or amphibious commanders to facilitate the rapid engagement of targets and simultaneously provide safeguards for friendly forces. Fire support control measures should be labeled with the abbreviation of the control measure, the controlling headquarters (Field T) and the effective times (Field W/W1). For lines this labeling should be on both ends of the line and repeated as often as necessary for clarity along any line that passes through many boundaries.

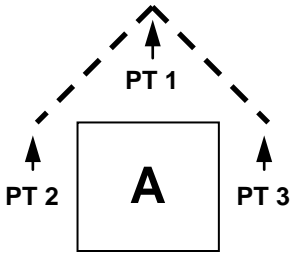
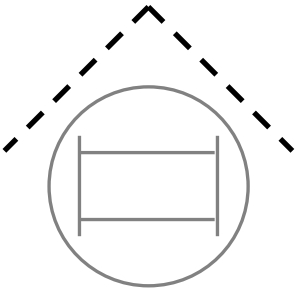
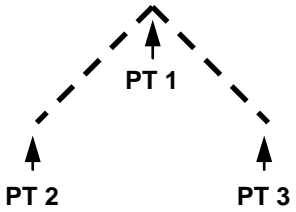
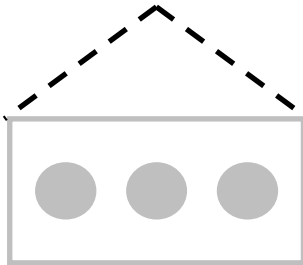
TABLE H-XVI. Fire Support Coordination Measures.

CONTROL MEASURE	TEMPLATE	DRAW RULES	EXAMPLE Note: The symbols that have been colored grey are used to help explain how the control measure is used, but they are not a part of the control measure.
Fire Areas Symbol Set Code: 25 Code: 240000	N/A		N/A
Airspace Coordination Area (ACA) Symbol Set Code: 25 Code: 240100	N/A		N/A

TABLE H-XVI. Fire Support Coordination Measures - Continued.

CONTROL MEASURE	TEMPLATE	DRAW RULES	EXAMPLE Note: The symbols that have been colored grey are used to help explain how the control measure is used, but they are not a part of the control measure.
<p>Airspace Coordination Area (ACA) - Irregular</p> <p>A restricted area or route of travel specified for use by friendly aircraft and established for the purpose of preventing friendly aircraft from being fired on by friendly forces. (AArtyP-5)</p> <p>Symbol Set Code: 25 Code: 240101</p> <p>Static/Dynamic: D</p>		<p><u>Anchor Points.</u> This graphic requires at least three anchor points to define the boundary of the area. Add as many points as necessary to accurately reflect the area's size and shape.</p> <p><u>Size/Shape.</u> Determined by the anchor points. The information fields should be moveable and scalable as a block within the area.</p> <p><u>Orientation.</u> Not applicable.</p>	

TABLE H-XVI. Fire Support Coordination Measures - Continued.

CONTROL MEASURE	TEMPLATE	DRAW RULES	EXAMPLE Note: The symbols that have been colored grey are used to help explain how the control measure is used, but they are not a part of the control measure.
<p>Airspace Coordination Area (ACA) - Rectangle</p> <p>Symbol Set Code: 25 Code: 240102</p> <p>Static/Dynamic: D</p>		<p><u>Anchor Points.</u> This symbol requires two anchor points and a width, defined in meters, to define the boundary of the area. Points 1 and 2 will be located in the center of two opposing sides of the rectangle.</p> <p><u>Size/Shape.</u> Size: As determined by the anchor points. The anchor points determine the length of the rectangle. The width, defined in meters, will determine the width of the rectangle.</p> <p>Shape: Rectangle. The information fields should be moveable and scalable.</p> <p><u>Orientation.</u> As determined by the anchor points.</p>	<div style="border: 1px solid black; padding: 10px;"> <p>ACA 53ID (M) MIN ALT: 500 FT AGL MAX ALT: 3000 FT AGL Grids NK2313 to NK3013</p> <p>EFF: 281400ZAPR08 – 281530ZAPR08</p> </div>

TABLE H-XVI. Fire Support Coordination Measures - Continued.

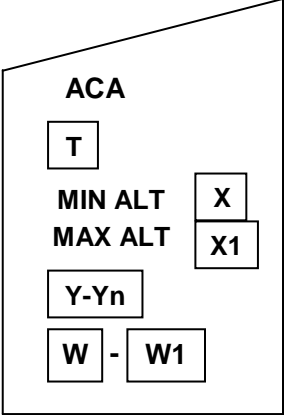
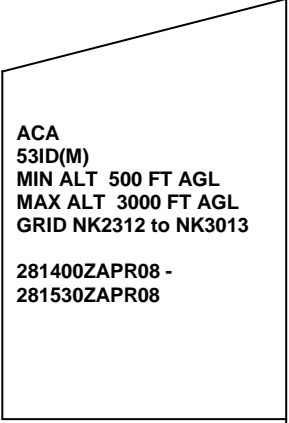

CONTROL MEASURE	TEMPLATE	DRAW RULES	EXAMPLE Note: The symbols that have been colored grey are used to help explain how the control measure is used, but they are not a part of the control measure.
<p>Airspace Coordination Area (ACA) – Circular</p> <p>Symbol Set Code: 25 Code: 240103</p> <p>Static/Dynamic: D</p>		<p><u>Anchor Points.</u> This symbol requires one (1) anchor point and a radius. Point 1 defines the center point of the symbol.</p> <p><u>Size/Shape.</u> Size: The radius defines the size. Shape: Circle.</p> <p>The information fields should be scalable within the circle.</p> <p><u>Orientation.</u> Not applicable.</p>	
<p>Free Fire Area (FFA)</p> <p>Symbol Set Code: 25 Code: 240200</p>	<p>N/A</p>	<p>N/A</p>	<p>N/A</p>

TABLE H-XVI. Fire Support Coordination Measures - Continued.

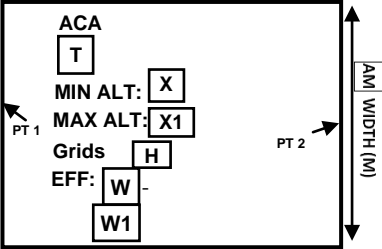

CONTROL MEASURE	TEMPLATE	DRAW RULES	EXAMPLE Note: The symbols that have been colored grey are used to help explain how the control measure is used, but they are not a part of the control measure.
<p>Free Fire Area (FFA) - Irregular</p> <p>A specific designated area into which any weapon system may fire without additional coordination with the establishing headquarters.</p> <p>Symbol Set Code: 25 Code: 240201</p> <p>Static/Dynamic: D</p>		<p><u>Anchor Points.</u> This graphic requires at least three anchor points to define the boundary of the area. Add as many points as necessary to accurately reflect the area's size and shape.</p> <p><u>Size/Shape.</u> Determined by the anchor points. The information fields should be moveable and scalable as a block within the area.</p> <p><u>Orientation.</u> Not applicable.</p>	

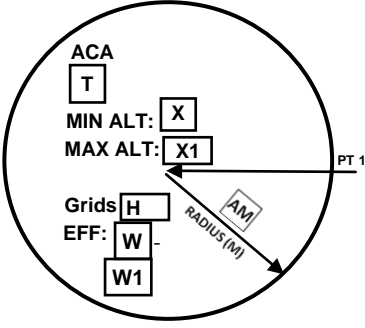
TABLE H-XVI. Fire Support Coordination Measures - Continued.

CONTROL MEASURE	TEMPLATE	DRAW RULES	EXAMPLE Note: The symbols that have been colored grey are used to help explain how the control measure is used, but they are not a part of the control measure.
<p>Free Fire Area (FFA) – Rectangle</p> <p>Symbol Set Code: 25 Code: 240202</p> <p>Static/Dynamic: D</p>		<p><u>Anchor Points.</u> This symbol requires two anchor points and a width, defined in meters, to define the boundary of the area. Points 1 and 2 will be located in the center of two opposing sides of the rectangle.</p> <p><u>Size/Shape.</u> Size: As determined by the anchor points. The anchor points determine the length of the rectangle. The width, defined in meters, will determine the width of the rectangle.</p> <p>Shape: Rectangle. The information fields should be moveable and scalable.</p> <p><u>Orientation.</u> As determined by the anchor points.</p>	<div style="border: 1px solid black; padding: 10px; text-align: center;"> <p>FFA</p> <p>X CORPS</p> <p>051030ZAPR08 – 051600ZAPR08</p> </div>

TABLE H-XVI. Fire Support Coordination Measures - Continued.

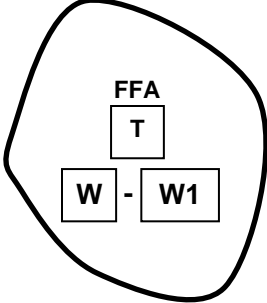
CONTROL MEASURE	TEMPLATE	DRAW RULES	EXAMPLE Note: The symbols that have been colored grey are used to help explain how the control measure is used, but they are not a part of the control measure.
<p>Free Fire Area (FFA) – Circular</p> <p>Symbol Set Code: 25 Code: 240203</p> <p>Static/Dynamic: D</p>		<p><u>Anchor Points.</u> This symbol requires one (1) anchor point and a radius. Point 1 defines the center point of the symbol.</p> <p><u>Size/Shape.</u> Size: The radius defines the size. Shape: Circle. The information fields should be scalable within the circle.</p> <p><u>Orientation.</u> Not applicable.</p>	
<p>No Fire Area (NFA)</p> <p>Symbol Set Code: 25 Code: 240300</p>	<p>N/A</p>		<p>N/A</p>

TABLE H-XVI. Fire Support Coordination Measures - Continued.

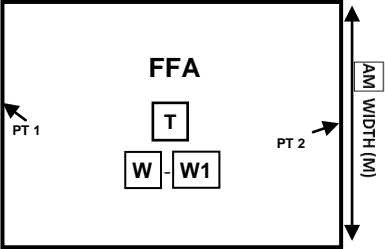

CONTROL MEASURE	TEMPLATE	DRAW RULES	EXAMPLE Note: The symbols that have been colored grey are used to help explain how the control measure is used, but they are not a part of the control measure.
<p>No Fire Area (NFA) - Irregular</p> <p>A area into which no fires or the effects of fires are allowed.</p> <p>Symbol Set Code: 25 Code: 240301</p> <p>Static/Dynamic: D</p>		<p><u>Anchor Points.</u> This graphic requires at least three anchor points to define the boundary of the area. Add as many points as necessary to accurately reflect the area's size and shape.</p> <p><u>Size/Shape.</u> Determined by the anchor points. The information fields should be moveable and scalable as a block within the area.</p> <p><u>Orientation.</u> Not applicable.</p>	

TABLE H-XVI. Fire Support Coordination Measures - Continued.

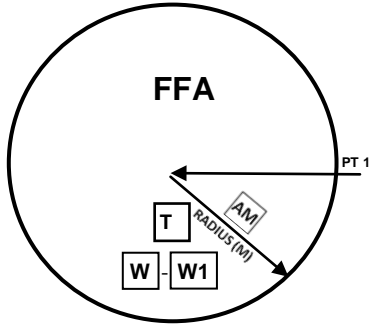
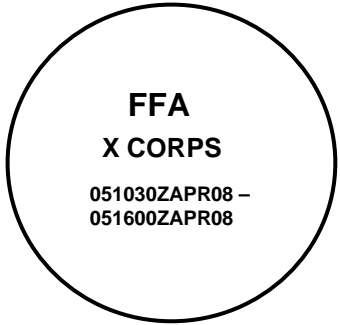

CONTROL MEASURE	TEMPLATE	DRAW RULES	EXAMPLE
<p>No Fire Area (NFA) – Rectangular</p> <p>Symbol Set Code: 25 Code: 240302</p> <p>Static/Dynamic: D</p>		<p><u>Anchor Points.</u> This symbol requires two anchor points and a width, defined in meters, to define the boundary of the area. Points 1 and 2 will be located in the center of two opposing sides of the rectangle.</p> <p><u>Size/Shape.</u> Size: As determined by the anchor points. The anchor points determine the length of the rectangle. The width, defined in meters, will determine the width of the rectangle.</p> <p>Shape: Rectangle. The information fields should be moveable and scalable.</p> <p><u>Orientation.</u> As determined by the anchor points.</p>	<p>EXAMPLE</p> <p>Note: The symbols that have been colored grey are used to help explain how the control measure is used, but they are not a part of the control measure.</p> 

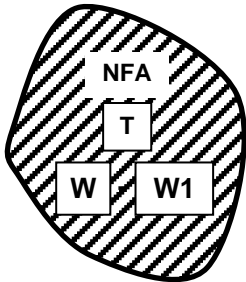
TABLE H-XVI. Fire Support Coordination Measures - Continued.

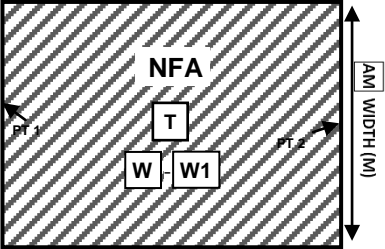

CONTROL MEASURE	TEMPLATE	DRAW RULES	EXAMPLE Note: The symbols that have been colored grey are used to help explain how the control measure is used, but they are not a part of the control measure.
<p>No Fire Area (NFA) – Circular</p> <p>Symbol Set Code: 25 Code: 240303</p> <p>Static/Dynamic: D</p>		<p><u>Anchor Points.</u> This symbol requires one (1) anchor point and a radius. Point 1 defines the center point of the symbol.</p> <p><u>Size/Shape.</u> Size: The radius defines the size. Shape: Circle.</p> <p>The information fields should be scalable within the circle.</p> <p><u>Orientation.</u> Not applicable.</p>	
<p>Restricted Fire Area (RFA)</p> <p>Symbol Set Code: 25 Code: 240400</p>	<p>N/A</p>		<p>N/A</p>

TABLE H-XVI. Fire Support Coordination Measures - Continued.

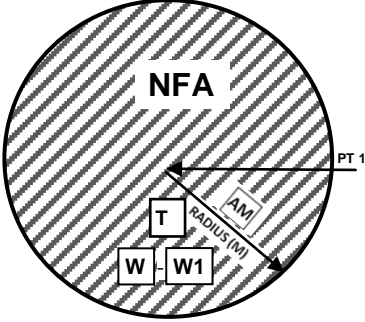

CONTROL MEASURE	TEMPLATE	DRAW RULES	EXAMPLE Note: The symbols that have been colored grey are used to help explain how the control measure is used, but they are not a part of the control measure.
<p>Restricted Fire Area (RFA) - Irregular</p> <p>An area in which specific restrictions are imposed and in which fires that exceed those restrictions are not delivered without coordination with the establishing headquarters. (AartyP-5).</p> <p>Symbol Set Code: 25 Code: 240401</p> <p>Static/Dynamic: D</p>		<p><u>Anchor Points.</u> This graphic requires at least three anchor points to define the boundary of the area. Add as many points as necessary to accurately reflect the area's size and shape.</p> <p><u>Size/Shape.</u> Determined by the anchor points. The information fields should be moveable and scalable as a block within the area.</p> <p><u>Orientation.</u> Not applicable.</p>	

TABLE H-XVI. Fire Support Coordination Measures - Continued.

CONTROL MEASURE	TEMPLATE	DRAW RULES	EXAMPLE Note: The symbols that have been colored grey are used to help explain how the control measure is used, but they are not a part of the control measure.
<p>Restricted Fire Area (RFA) – Rectangular</p> <p>Symbol Set Code: 25 Code: 240402</p> <p>Static/Dynamic: D</p>		<p><u>Anchor Points.</u> This symbol requires two anchor points and a width, defined in meters, to define the boundary of the area. Points 1 and 2 will be located in the center of two opposing sides of the rectangle.</p> <p><u>Size/Shape.</u> Size: As determined by the anchor points. The anchor points determine the length of the rectangle. The width, defined in meters, will determine the width of the rectangle.</p> <p>Shape: Rectangle. The information fields should be moveable and scalable.</p> <p><u>Orientation.</u> As determined by the anchor points.</p>	

TABLE H-XVI. Fire Support Coordination Measures - Continued.

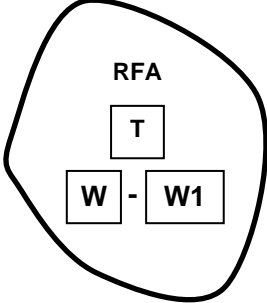

CONTROL MEASURE	TEMPLATE	DRAW RULES	EXAMPLE Note: The symbols that have been colored grey are used to help explain how the control measure is used, but they are not a part of the control measure.
<p>Restricted Fire Area (RFA) – Circular</p> <p>Symbol Set Code: 25 Code: 240403</p> <p>Static/Dynamic: D</p>		<p><u>Anchor Points.</u> This symbol requires one (1) anchor point and a radius. Point 1 defines the center point of the symbol.</p> <p><u>Size/Shape.</u> Size: The radius defines the size. Shape: Circle. The information fields should be scalable within the circle.</p> <p><u>Orientation.</u> Not applicable.</p>	
<p>Position Area For Artillery (PAA)</p> <p>Symbol Set Code: 25 Code: 240500</p>	<p>N/A</p>		<p>N/A</p>

TABLE H-XVI. Fire Support Coordination Measures - Continued.

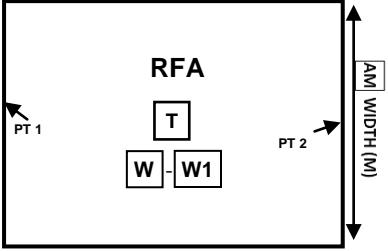
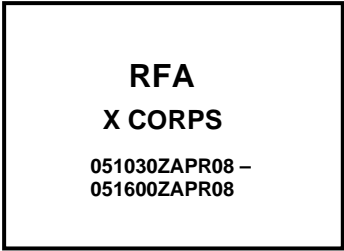
CONTROL MEASURE	TEMPLATE	DRAW RULES	EXAMPLE Note: The symbols that have been colored grey are used to help explain how the control measure is used, but they are not a part of the control measure.
<p>Position Area For Artillery (PAA) - Rectangular</p> <p>Symbol Set Code: 25 Code: 240501</p> <p>Static/Dynamic: D</p>		<p><u>Anchor Points.</u> This symbol requires two anchor points and a width, defined in meters, to define the boundary of the area. Points 1 and 2 will be located in the center of two opposing sides of the rectangle.</p> <p><u>Size/Shape.</u> Size: As determined by the anchor points. The anchor points determine the length of the rectangle. The width, defined in meters, will determine the width of the rectangle.</p> <p>Shape: Rectangle. The information fields should be moveable and scalable.</p> <p><u>Orientation.</u> As determined by the anchor points.</p>	

TABLE H-XVI. Fire Support Coordination Measures - Continued.

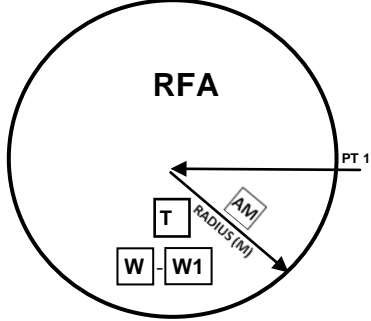
CONTROL MEASURE	TEMPLATE	DRAW RULES	EXAMPLE Note: The symbols that have been colored grey are used to help explain how the control measure is used, but they are not a part of the control measure.
<p>Position Area For Artillery (PAA) - Circular</p> <p>Symbol Set Code: 25 Code: 240502</p> <p>Static/Dynamic: D</p>		<p><u>Anchor Points.</u> This symbol requires one (1) anchor point and a radius. Point 1 defines the center point of the symbol.</p> <p><u>Size/Shape.</u> Size: The radius defines the size. Shape: Circle. The information fields should be scalable within the circle.</p> <p><u>Orientation.</u> Not applicable.</p>	
<p>Fire Lines</p> <p>Symbol Set Code: 25 Code: 260000</p>	<p>N/A</p>		<p>N/A</p>
<p>Fire Support Coordination Line (FSCL)</p> <p>Note: Because of the length of the FSCL definition it is included in the glossary.</p> <p>Symbol Set Code: 25 Code: 260100</p> <p>Static/Dynamic: D</p>		<p><u>Anchor Points.</u> This symbol requires at least two points, points 1 and 2, to define the line. Additional points can be defined to extend the line.</p> <p><u>Size/Shape.</u> The first and last anchor points determine the length of the line.</p> <p><u>Orientation.</u> Orientation is determined by the anchor points.</p>	 <p>The end-of line information will typically be posted at the ends of the line as it is shown in the example.</p>

TABLE H-XVI. Fire Support Coordination Measures - Continued.

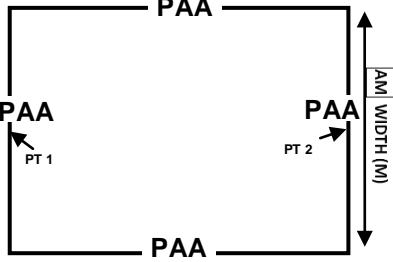
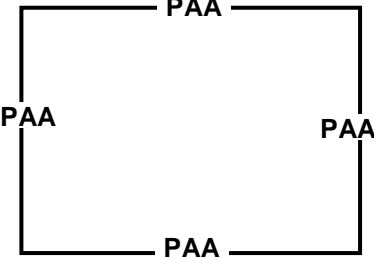

CONTROL MEASURE	TEMPLATE	DRAW RULES	EXAMPLE
<p>Coordinated Fire Line (CFL)</p> <p>Symbol Set Code: 25 Code: 260200</p> <p>Static/Dynamic: D</p>		<p><u>Anchor Points:</u> This symbol requires at least two anchor points, points 1 and 2, to define the line. Additional points can be defined to extend the line.</p> <p><u>Size/Shape:</u> The first and last anchor points determine the length of the line. The line information will be posted once at the center of the line as it is displayed on the screen.</p> <p><u>Orientation:</u> Orientation is determined by the order in which the anchor points are entered.</p>	<p>Note: The symbols that have been colored grey are used to help explain how the control measure is used, but they are not a part of the control measure.</p> 
<p>No Fire Line</p> <p>Symbol Set Code: 25 Code: 260300</p>		<p><u>Anchor Points.</u> This symbol requires at least two points, points 1 and 2, to define the line. Additional points can be defined to</p>	

TABLE H-XVI. Fire Support Coordination Measures - Continued.

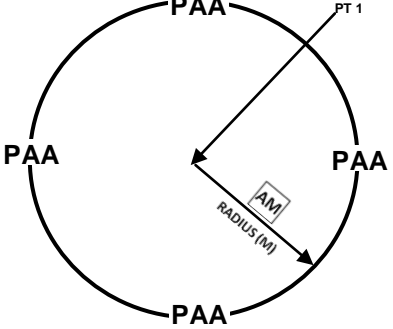
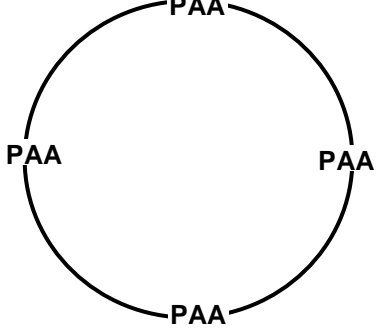
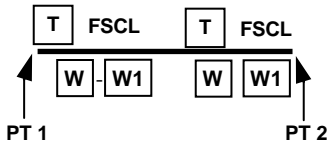
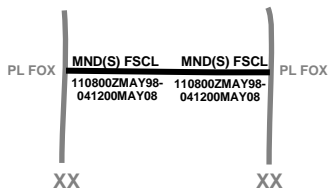
CONTROL MEASURE	TEMPLATE	DRAW RULES	EXAMPLE
<p>Battlefield Coordination Line</p> <p>Symbol Set Code: 25 Code: 260400</p>		<p>extend the line. <u>Size/Shape.</u> The first and last anchor points determine the length of the line. <u>Orientation.</u> Orientation is determined by the anchor points.</p> <p>Static/Dynamic: D</p>	<p>Note: The symbols that have been colored grey are used to help explain how the control measure is used, but they are not a part of the control measure.</p> 
<p>Restrictive Fire Line</p> <p>A line established between converging friendly forces (one or both may be moving) that prohibits all fire or effects from fires across the line without coordination with the affected force. (AartyP-5)</p> <p>Symbol Set Code: 25 Code: 260500</p>		<p>Static/Dynamic: D</p>	
<p>Munition Flight Path</p> <p>Symbol Set Code: 25 Code: 260600</p> <p>Note 1. "MFP" shall be displayed once at the approximate center of the overall length of the Munition Flight Path.</p>		<p><u>Anchor Points.</u> This graphic requires a minimum of two (2) anchor points. Up to 298 additional points can be added to extend the line. The first point (point 1) defines the start point. The last point defines the endpoint.</p>	

TABLE H-XVI. Fire Support Coordination Measures - Continued.

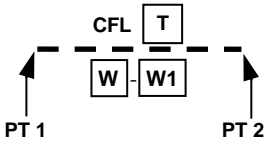
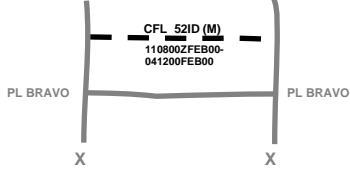
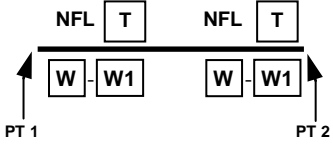
CONTROL MEASURE	TEMPLATE	DRAW RULES	EXAMPLE Note: The symbols that have been colored grey are used to help explain how the control measure is used, but they are not a part of the control measure.
<p>Note 2. The MFP begins at a weapon system/surface-to-surface fires unit and terminates at a target.</p> <p>Note 3. The effective DTG of the MFP is the shot/launch time of the projectile. The expiration DTG of the MFP is the splash/time of impact of the projectile. DTGs are not required to be displayed. If the DTG is displayed, it shall be displayed one time mid way between Point 1 and midpoint of the graphic.</p> <p>Note 4. The 3D display of a MFP requires a height value for each anchor point.</p>		<p>The points are numbered sequentially beginning with point one (1), in increments of one.</p> <p><u>Size/Shape.</u> The anchor points define the size and shape.</p> <p><u>Orientation.</u> The orientation is determined by the anchor points.</p> <p>Static/Dynamic: D</p>	

H.5.19 Targets.

H.5.19.1 Targets. Are the objects of a particular action, for example a geographic area, a complex, an installation, a force, equipment, an individual, a group or a system, planned for capture, exploitation, neutralization or destruction by military forces.

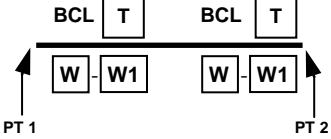
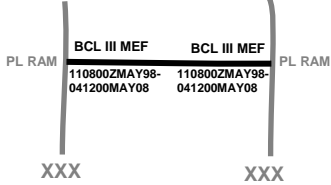
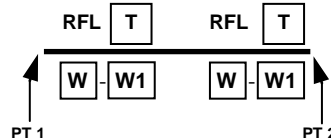
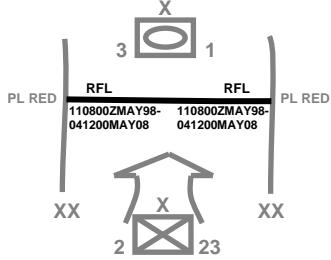
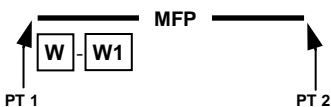
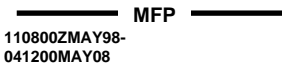
TABLE H-XVII. Target control measure symbols.

CONTROL MEASURE	TEMPLATE	DRAW RULES	EXAMPLE Note: The symbols that have been colored grey are used to help explain how the control measure is used, but they are not a part of the control measure.
<i>Point Targets</i>			
<p>Point Targets</p> <p>Symbol Set Code: 25 Code: 240600</p>	N/A		N/A
<p>Point or Single Target</p> <p>A target which requires the accurate placement of bombs or fire. Note: Guidance on building target numbers is found in AArtyP-1.</p> <p>Symbol Set Code: 25 Code: 240601</p>		<p><u>Anchor Points.</u> This symbol requires one anchor point. The center point defines/is the center of the symbol. <u>Size/Shape.</u> Static. <u>Orientation.</u> The symbol is typically centered over the desired location.</p>	
<p>Nuclear Target</p> <p>Note: The point at the center of the target represents the desired ground zero.</p> <p>Symbol Set Code: 25 Code: 240602</p>		<p>Static/ Dynamic: S</p>	

TABLE H-XVII. Target control measure symbols – Continued.

CONTROL MEASURE	TEMPLATE	DRAW RULES	EXAMPLE Note: The symbols that have been colored grey are used to help explain how the control measure is used, but they are not a part of the control measure.
<p>Target-Recorded</p> <p>(AEGIS Only)</p> <p>Symbol Set Code: 25 Code: 240603</p> <p>Static/Dynamic: S</p>	 <p>Center Point</p>	<p><u>Anchor Points.</u> This symbol requires one center point. The point defines the center of the symbol. <u>Size/Shape:</u> Static. Length is 2x the size of height. <u>Orientation:</u> The symbol is centered over the desired location. The symbol shall be oriented upright.</p>	
<p>Linear Targets</p> <p>Symbol Set Code: 25 Code: 240700</p>	<p>N/A</p>		<p>N/A</p>
<p>Linear Target</p> <p>Symbol Set Code: 25 Code: 240701</p>	 <p>PT 1 PT 2</p>	<p><u>Anchor Points.</u> This symbol requires two anchor points. Points 1 and 2 define the endpoints of the symbol. <u>Size/Shape.</u> The symbol varies only in length.</p>	 <p>LA2961</p>
<p>Linear Smoke Target</p> <p>Symbol Set Code: 25 Code: 240702</p>	 <p>PT 1 PT 2</p> <p>SMOKE</p>	<p><u>Anchor Points.</u> One point defines the</p>	 <p>VB1910</p> <p>SMOKE</p>

TABLE H-XVII. Target control measure symbols – Continued.

CONTROL MEASURE	TEMPLATE	DRAW RULES	EXAMPLE Note: The symbols that have been colored grey are used to help explain how the control measure is used, but they are not a part of the control measure.
<p>Final Protective Fire (FPF)</p> <p>An immediately available prearranged barrier of fire designed to impede enemy movement across defensive lines or areas.</p> <p>Symbol Set Code: 25 Code: 240703</p>		<p>origin from which the bearing is being taken and the other point defines the location or direction from which a contact is made.</p> <p>Static/ Dynamic: D</p>	
<p>Area Targets</p> <p>Symbol Set Code: 25 Code: 240800</p>	<p>N/A</p>		<p>N/A</p>
<p>Area Target</p> <p>Symbol Set Code: 25 Code: 240801</p> <p>Static/Dynamic: D</p>		<p><u>Anchor Points.</u> This symbol requires at least three anchor points to define the boundary of the area. Add as many points as necessary to accurately reflect the area's size and shape.</p> <p><u>Size/Shape.</u> Determined by the anchor points. The information fields should be moveable and scalable as a block within the area.</p> <p><u>Orientation.</u> Not applicable.</p>	

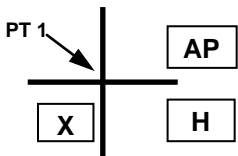
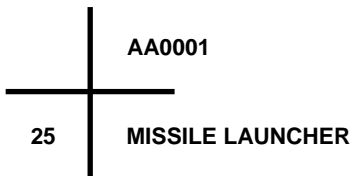
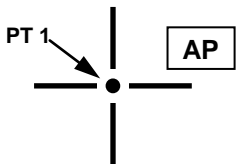
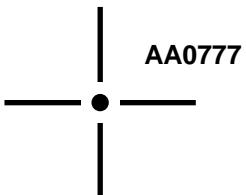
TABLE H-XVII. Target control measure symbols – Continued.

CONTROL MEASURE	TEMPLATE	DRAW RULES	EXAMPLE
<p>Rectangular Target</p> <p>Symbol Set Code: 25 Code: 240802</p> <p>Static/Dynamic: D</p>		<p><u>Anchor Points.</u> This symbol requires one (1) anchor point to define the center of the area.</p> <p><u>Size/Shape.</u> Size is determined by the anchor point, the target length (in meters) and target width (in meters). A rectangular target is wider and longer than 200 meters. The information fields should be moveable and scaleable within the area. Shape: Rectangle.</p> <p><u>Orientation.</u> As determined by the Target Attitude (in mils).</p>	<p>Note: The symbols that have been colored grey are used to help explain how the control measure is used, but they are not a part of the control measure.</p> <div style="border: 2px solid black; width: 150px; height: 80px; margin: 20px auto; text-align: center; line-height: 80px;"> <p>DM0065</p> </div>

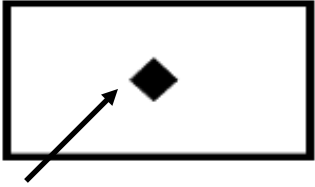
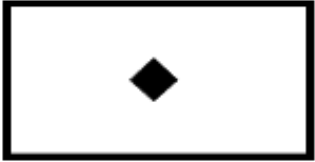
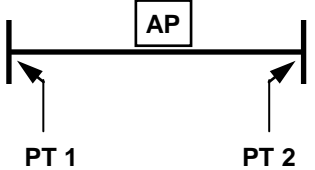
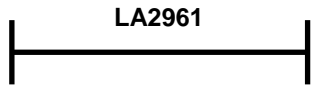
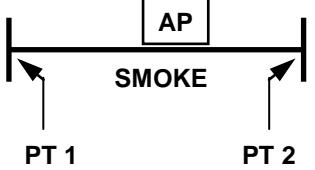
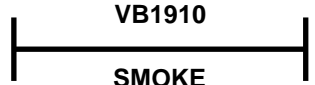
TABLE H-XVII. Target control measure symbols – Continued.

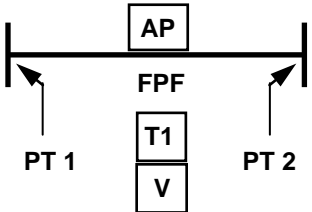
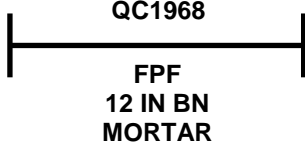
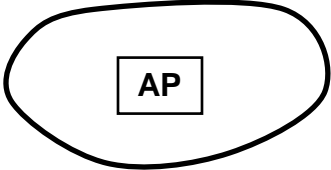
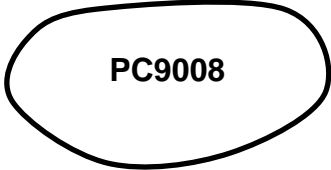

CONTROL MEASURE	TEMPLATE	DRAW RULES	EXAMPLE Note: The symbols that have been colored grey are used to help explain how the control measure is used, but they are not a part of the control measure.
<p>Circular Target</p> <p>Symbol Set Code: 25 Code: 240803</p> <p>Static/Dynamic: D</p>		<p><u>Anchor Points.</u> This symbol requires one (1) anchor point. Point 1 defines the center point of the symbol.</p> <p><u>Size/Shape.</u> Size: The radius defines the size. Shape: Circle. The information fields should be scalable within the circle.</p> <p><u>Orientation.</u> Not applicable.</p>	

TABLE H-XVII. Target control measure symbols – Continued.

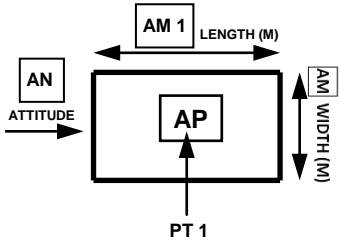
CONTROL MEASURE	TEMPLATE	DRAW RULES	EXAMPLE Note: The symbols that have been colored grey are used to help explain how the control measure is used, but they are not a part of the control measure.
<p>Rectangular Target – Single Target</p> <p>(AEGIS Only)</p> <p>Symbol Set Code: 25 Code: 240804</p> <p>Static/Dynamic: D</p>	 <p>Area: This symbol requires two anchor points and a width (defined in meters) to define the boundary of the area. Points 1 and 2 will be located on the opposite sides of the area.</p>	<p><u>Anchor Points.</u> This symbol requires one anchor (center) point to define the center of the symbol. The target tactical symbol shall be centered upon the center of the area. The size and the orientation of the target symbol are fixed within the area.</p> <p><u>Size/Shape.</u> As determined by the anchor points. The anchor points determine the area's length. Width, determined in meters, will define the width of the rectangle.</p> <p><u>Orientation.</u> As determined by the anchor points. The center point of the area, shall always have the target symbol with the same upright orientation.</p>	

TABLE H-XVII. Target control measure symbols – Continued.

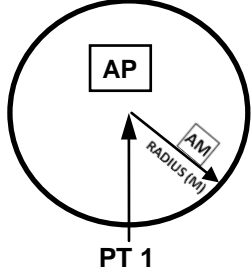
CONTROL MEASURE	TEMPLATE	DRAW RULES	EXAMPLE Note: The symbols that have been colored grey are used to help explain how the control measure is used, but they are not a part of the control measure.
<p>Series or Group of Targets</p> <p>In artillery and naval fire support, a number of targets and/or group(s) of targets planned to support a maneuver phase.</p> <p>A series of targets may be indicated by a nickname.</p> <p>A group of targets is designated by a letter/number combination or a nickname.</p> <p>Symbol Set Code: 25 Code: 240805</p>	<p>Point Targets</p> 	<p><u>Anchor Points.</u> This symbol requires at least three anchor points to define the boundary of the area. Add as many points as necessary to accurately reflect the area's size and shape.</p> <p><u>Size/Shape.</u> Determined by the anchor points.</p> <p><u>Orientation.</u> Not applicable.</p> <p>The area will encompass two or more fire support symbols (point/single target, nuclear target, circular target, rectangular target, or area target). The naming convention determines whether the area describes a series or group of targets.</p> <p>Static/ Dynamic: D</p>	
	<p>Point Targets</p> 		<p>Targets and Groups of Targets</p> 
	<p>Linear Targets</p>  <p>Area Targets</p> 		  

TABLE H-XVII. Target control measure symbols – Continued.

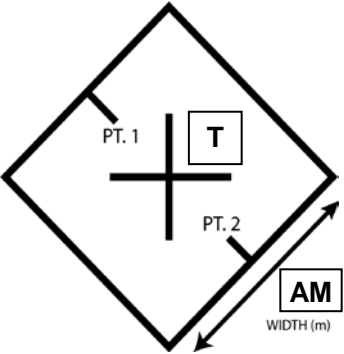
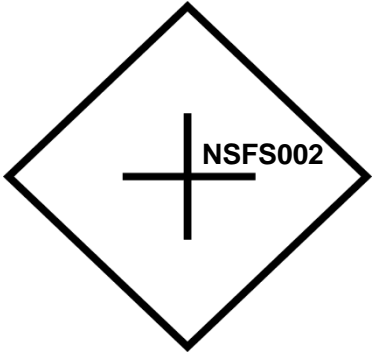

CONTROL MEASURE	TEMPLATE	DRAW RULES	EXAMPLE Note: The symbols that have been colored grey are used to help explain how the control measure is used, but they are not a part of the control measure.
<p>Smoke</p> <p>Symbol Set Code: 25 Code: 240806</p>		<p><u>Anchor Points.</u> This symbol requires at least three anchor points to define the boundary of the area. Add</p>	
<p>Smoke Planned or On Order</p> <p>Symbol Set Code: 25 Code: 240807</p>		<p>as many points as necessary to accurately reflect the area's size and shape.</p>	
<p>Bomb Area</p> <p>Symbol Set Code: 25 Code: 240808</p>		<p><u>Size/Shape.</u> Determined by the anchor points. The information field should be moveable and scalable as a block within the area.</p> <p><u>Orientation.</u> Not applicable.</p> <p>Static/ Dynamic: D</p>	
<i>Naval Gunfire</i>			
<p>Fire Support Station</p> <p>An exact location at sea within a fire support area from which a fire support ship delivers fire.</p> <p>Symbol Set Code: 25 Code: 240900</p> <p>Static/Dynamic: D</p>		<p><u>Anchor Points.</u> This symbol requires one anchor point. The center point defines/is the center of the symbol.</p> <p><u>Size/Shape.</u> Static.</p> <p><u>Orientation.</u> The symbol is typically centered over the desired location.</p>	

TABLE H-XVII. Target control measure symbols – Continued.

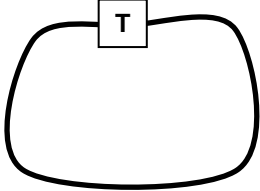
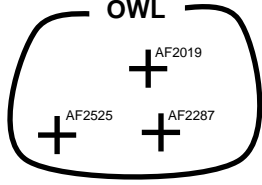
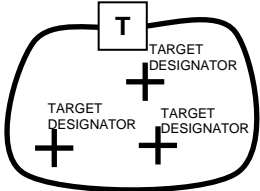
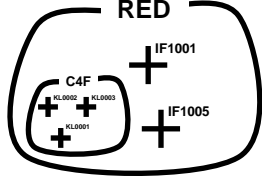
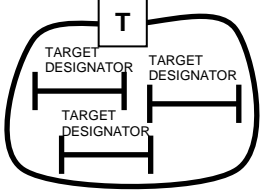
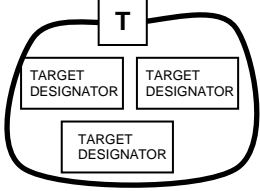
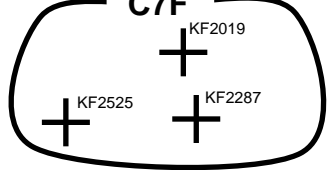
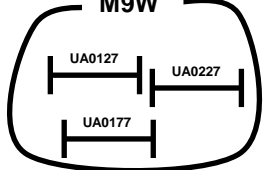
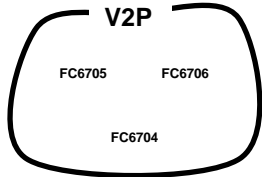

CONTROL MEASURE	TEMPLATE	DRAW RULES	EXAMPLE Note: The symbols that have been colored grey are used to help explain how the control measure is used, but they are not a part of the control measure.
<p>Fire Support Area</p> <p>Symbol Set Code: 25 Code: 241000</p>	<p>N/A</p>		<p>N/A</p>
<p>Fire Support Area - Irregular</p> <p>An appropriate maneuver area assigned to fire support ships from which to deliver gun-fire support of an amphibious operation.</p> <p>Symbol Set Code: 25 Code: 241001</p> <p>Static/Dynamic: D</p>		<p><u>Anchor Points.</u> This symbol requires at least three anchor points to define the boundary of the area. Add as many points as necessary to accurately reflect the area's size and shape.</p> <p><u>Size/Shape.</u> Determined by the anchor points. The information fields should be moveable and scalable as a block within the area.</p> <p><u>Orientation.</u> Not applicable.</p>	 <p>010700ZJAN08 - 010745ZJAN08</p>

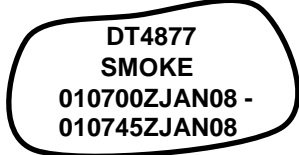
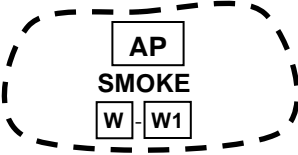
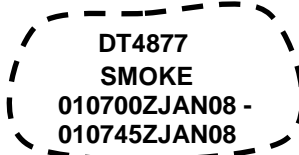
TABLE H-XVII. Target control measure symbols – Continued.

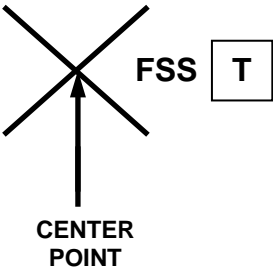
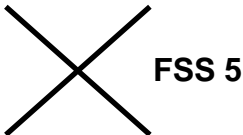
CONTROL MEASURE	TEMPLATE	DRAW RULES	EXAMPLE Note: The symbols that have been colored grey are used to help explain how the control measure is used, but they are not a part of the control measure.
<p>Fire Support Area - Rectangular</p> <p>Symbol Set Code: 25 Code: 241002</p> <p>Static/Dynamic: D</p>		<p><u>Anchor Points.</u> This symbol requires two anchor points and a width, defined in meters, to define the boundary of the area. Points 1 and 2 will be located in the center of two opposing sides of the rectangle.</p> <p><u>Size/Shape.</u> Size: As determined by the anchor points. The anchor points determine the length of the rectangle. The width, defined in meters, will determine the width of the rectangle.</p> <p>Shape: Rectangle. The information fields should be moveable and scalable.</p> <p><u>Orientation.</u> As determined by the anchor points.</p>	<p>010700ZJAN08 - 010745ZJAN08</p> <div style="border: 1px solid black; padding: 10px; width: fit-content; margin: 10px auto;"> <p style="text-align: center;">FSA GREEN</p> </div>

TABLE H-XVII. Target control measure symbols – Continued.

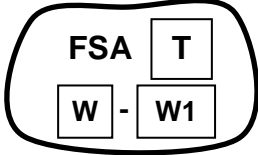

CONTROL MEASURE	TEMPLATE	DRAW RULES	EXAMPLE Note: The symbols that have been colored grey are used to help explain how the control measure is used, but they are not a part of the control measure.
<p>Fire Support Area - Circular</p> <p>Symbol Set Code: 25 Code: 241003</p> <p>Static/Dynamic: D</p>		<p><u>Anchor Points.</u> This symbol requires one (1) anchor point and a radius. Point 1 defines the center point of the symbol.</p> <p><u>Size/Shape.</u> Size: The radius defines the size. Shape: Circle. The information fields should be scalable within the circle.</p> <p><u>Orientation.</u> Not applicable.</p>	<p>010700ZJAN08 - 010745ZJAN08</p> 
<i>Field Artillery</i>			
<p>Fires Points</p> <p>Symbol Set Code: 25 Code: 250000</p>	N/A		N/A
<p>Firing Point</p> <p>Symbol Set Code: 25 Code: 250100</p>		<p><u>Anchor Points.</u> This symbol requires one anchor point. The point defines/is the tip of the inverted cone.</p> <p><u>Size/Shape.</u> Static.</p> <p><u>Orientation.</u> The symbol will typically</p>	<p>060900ZFEB08 - 100300ZFEB08</p> 

TABLE H-XVII. Target control measure symbols – Continued.

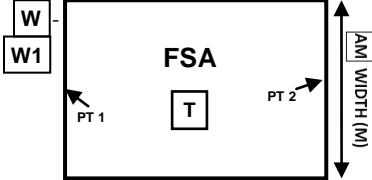
CONTROL MEASURE	TEMPLATE	DRAW RULES	EXAMPLE Note: The symbols that have been colored grey are used to help explain how the control measure is used, but they are not a part of the control measure.
<p>Hide Point</p> <p>Symbol Set Code: 25 Code: 250200</p>		<p>be oriented upright.</p> <p>Static/ Dynamic: S</p>	<p>070700ZMAR08 - 2 110500ZMAR08 - 3</p> 
<p>Launch Point</p> <p>Symbol Set Code: 25 Code: 250300</p>			<p>100200ZAUG08 - 6 110800ZAUG08 - 4</p> 
<p>Reload Point</p> <p>Symbol Set Code: 25 Code: 250400</p>			<p>061000ZNOV08 - 6 120800ZNOV08 - B</p> 

TABLE H-XVII. Target control measure symbols – Continued.

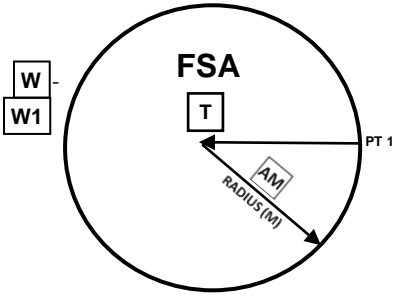
CONTROL MEASURE	TEMPLATE	DRAW RULES	EXAMPLE Note: The symbols that have been colored grey are used to help explain how the control measure is used, but they are not a part of the control measure.
Survey Control Point Symbol Set Code: 25 Code: 250500			

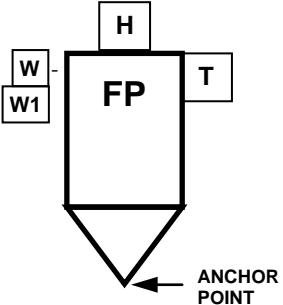
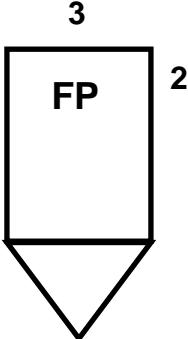
H.5.20 Target acquisition.

H.5.20.1 Target acquisition. The detection, identification and location of a target in sufficient detail to permit the effective employment of weapons.

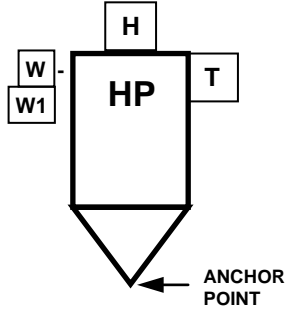
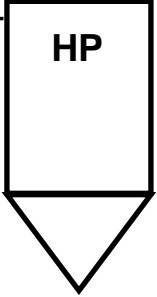
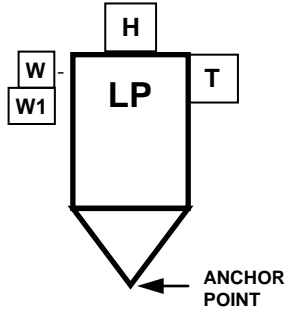
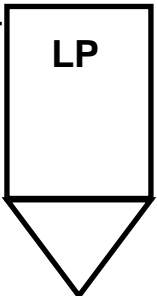
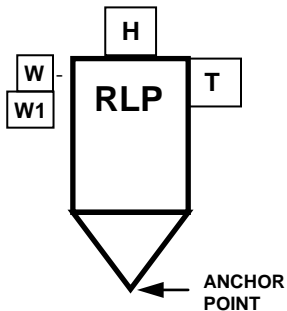
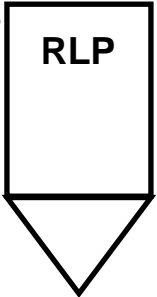
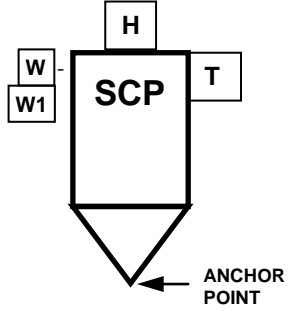
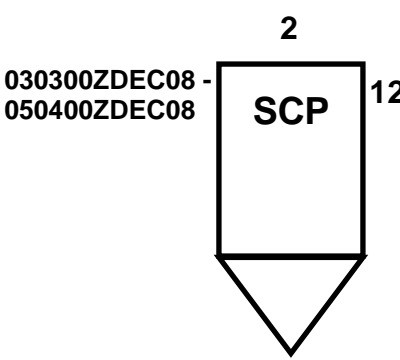
TABLE H-XVIII. Target acquisition control measure symbols.

CONTROL MEASURE	TEMPLATE	DRAW RULES	EXAMPLE Note: The symbols that have been colored grey are used to help explain how the control measure is used, but they are not a part of the control measure.
Artillery Target Intelligence Zone (ATI) Symbol Set Code: 25 Code: 241100	N/A		N/A

TABLE H-XVIII. Target acquisition control measure symbols - Continued.

CONTROL MEASURE	TEMPLATE	DRAW RULES	EXAMPLE Note: The symbols that have been colored grey are used to help explain how the control measure is used, but they are not a part of the control measure.
<p>Artillery Target Intelligence Zone (ATI), Irregular</p> <p>An area in enemy territory that the commander wishes to monitor closely.</p> <p>Symbol Set Code: 25 Code: 241101</p> <p>Static/Dynamic: D</p>		<p><u>Anchor Points.</u> This symbol requires a minimum of three (3) and a maximum of six (6) anchor points to define the boundary of the area. The anchor points shall be sequentially numbered, in increments of one (1), beginning with point one (1).</p> <p><u>Size/Shape.</u> Determined by the anchor points. The information fields should be moveable and scalable within the area.</p> <p><u>Orientation.</u> Not applicable.</p>	<p>020300ZDEC08 - 090500ZDEC08</p> 

TABLE H-XVIII. Target acquisition control measure symbols - Continued.



CONTROL MEASURE	TEMPLATE	DRAW RULES	EXAMPLE Note: The symbols that have been colored grey are used to help explain how the control measure is used, but they are not a part of the control measure.
<p>Artillery Target Intelligence Zone (ATI), Rectangular</p> <p>Symbol Set Code: 25 Code: 241102</p> <p>Static/Dynamic: D</p>		<p><u>Anchor Points.</u> This symbol requires two anchor points and a width, defined in meters, to define the boundary of the area. Points 1 and 2 will be located in the center of two opposing sides of the rectangle.</p> <p><u>Size/Shape.</u> Size: As determined by the anchor points. The anchor points determine the length of the rectangle. The width, defined in meters, will determine the width of the rectangle.</p> <p>Shape: Rectangle. The information fields should be moveable and scalable.</p> <p><u>Orientation.</u> As determined by the anchor points.</p>	<p>020300ZDEC08 - 090500ZDEC08</p> 

TABLE H-XVIII. Target acquisition control measure symbols - Continued.

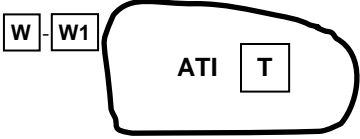
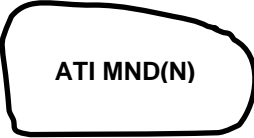
CONTROL MEASURE	TEMPLATE	DRAW RULES	EXAMPLE Note: The symbols that have been colored grey are used to help explain how the control measure is used, but they are not a part of the control measure.
<p>Artillery Target Intelligence Zone (ATI), Circular</p> <p>Symbol Set Code: 25 Code: 241103</p> <p>Static/Dynamic: D</p>		<p><u>Anchor Points.</u> This symbol requires one (1) anchor point and a radius. Point 1 defines the center point of the symbol.</p> <p><u>Size/Shape.</u> Size: The radius defines the size. Shape: Circle. The information fields should be scalable within the circle.</p> <p><u>Orientation.</u> Not applicable.</p>	<p>020300ZDEC08 - 090500ZDEC08</p> 
<p>Call For Fire Zone (CFFZ)</p> <p>Symbol Set Code: 25 Code: 241200</p>	<p>N/A</p>	<p>N/A</p>	<p>N/A</p>

TABLE H-XVIII. Target acquisition control measure symbols - Continued.

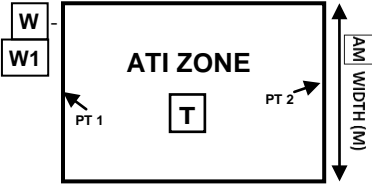

CONTROL MEASURE	TEMPLATE	DRAW RULES	EXAMPLE Note: The symbols that have been colored grey are used to help explain how the control measure is used, but they are not a part of the control measure.
<p>Call For Fire Zone (CFFZ), Irregular</p> <p>A search area from which the commander wants to attack hostile firing systems.</p> <p>Symbol Set Code: 25 Code: 241201</p> <p>Static/Dynamic: D</p>		<p><u>Anchor Points.</u> This symbol requires a minimum of three (3) and a maximum of six (6) anchor points to define the boundary of the area. The anchor points shall be sequentially numbered, in increments of one (1), beginning with point one (1).</p> <p><u>Size/Shape.</u> Determined by the anchor points. The information fields should be moveable and scalable within the area.</p> <p><u>Orientation.</u> Not applicable.</p>	<p>020300ZDEC08 - 090500ZDEC08</p> 

TABLE H-XVIII. Target acquisition control measure symbols - Continued.

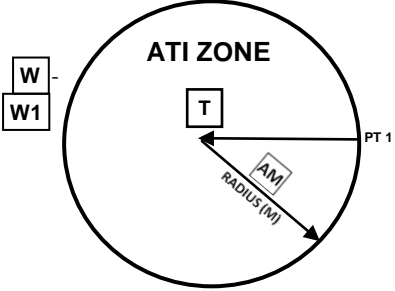
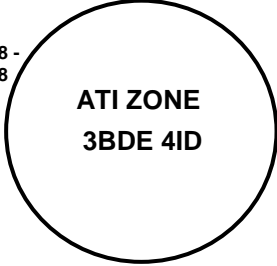
CONTROL MEASURE	TEMPLATE	DRAW RULES	EXAMPLE Note: The symbols that have been colored grey are used to help explain how the control measure is used, but they are not a part of the control measure.
<p>Call For Fire Zone (CFFZ), Rectangular</p> <p>Symbol Set Code: 25 Code: 241202</p> <p>Static/Dynamic: D</p>		<p><u>Anchor Points.</u> This symbol requires two anchor points and a width, defined in meters, to define the boundary of the area. Points 1 and 2 will be located in the center of two opposing sides of the rectangle.</p> <p><u>Size/Shape.</u> Size: As determined by the anchor points. The anchor points determine the length of the rectangle. The width, defined in meters, will determine the width of the rectangle.</p> <p>Shape: Rectangle. The information fields should be moveable and scalable.</p> <p><u>Orientation.</u> As determined by the anchor points.</p>	<p>020300ZDEC08 - 090500ZDEC08</p> <div style="border: 2px solid black; padding: 10px; width: fit-content; margin-left: auto; margin-right: auto;"> <p style="text-align: center;">CFF ZONE 3BDE 4ID</p> </div>

TABLE H-XVIII. Target acquisition control measure symbols - Continued.

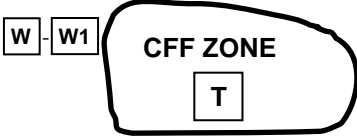
CONTROL MEASURE	TEMPLATE	DRAW RULES	EXAMPLE Note: The symbols that have been colored grey are used to help explain how the control measure is used, but they are not a part of the control measure.
<p>Call For Fire Zone (CFFZ), Circular</p> <p>Symbol Set Code: 25 Code: 241203</p> <p>Static/Dynamic: D</p>		<p><u>Anchor Points.</u> This symbol requires one (1) anchor point and a radius. Point 1 defines the center point of the symbol.</p> <p><u>Size/Shape.</u> Size: The radius defines the size. Shape: Circle. The information fields should be scalable within the circle.</p> <p><u>Orientation.</u> Not applicable.</p>	<p>020300ZDEC08 - 090500ZDEC08</p> 
<p>Censor Zone</p> <p>Symbol Set Code: 25 Code: 241300</p>	<p>N/A</p>	<p>N/A</p>	<p>N/A</p>

TABLE H-XVIII. Target acquisition control measure symbols - Continued.

CONTROL MEASURE	TEMPLATE	DRAW RULES	EXAMPLE Note: The symbols that have been colored grey are used to help explain how the control measure is used, but they are not a part of the control measure.
<p>Censor Zone, Irregular</p> <p>An area from which radar is prohibited from reporting acquisitions. (Normally placed around friendly weapons systems and is most often used in non-linear or cross forward line of own troop activities.)</p> <p>Symbol Set Code: 25 Code: 241301</p> <p>Static/Dynamic: D</p>		<p><u>Anchor Points.</u> This symbol requires a minimum of three (3) and a maximum of six (6) anchor points to define the boundary of the area. The anchor points shall be sequentially numbered, in increments of one (1), beginning with point one (1).</p> <p><u>Size/Shape.</u> Determined by the anchor points. The information fields should be moveable and scalable within the area.</p> <p><u>Orientation.</u> Not applicable.</p>	<p>020300ZDEC08 - 090500ZDEC08</p> 

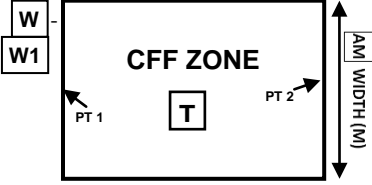
TABLE H-XVIII. Target acquisition control measure symbols - Continued.

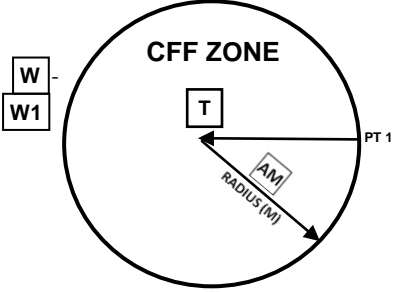
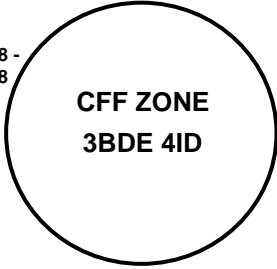

CONTROL MEASURE	TEMPLATE	DRAW RULES	EXAMPLE Note: The symbols that have been colored grey are used to help explain how the control measure is used, but they are not a part of the control measure.
<p>Censor Zone, Rectangular</p> <p>Symbol Set Code: 25 Code: 241302</p> <p>Static/Dynamic: D</p>		<p><u>Anchor Points.</u> This symbol requires two anchor points and a width, defined in meters, to define the boundary of the area. Points 1 and 2 will be located in the center of two opposing sides of the rectangle.</p> <p><u>Size/Shape.</u> Size: As determined by the anchor points. The anchor points determine the length of the rectangle. The width, defined in meters, will determine the width of the rectangle.</p> <p>Shape: Rectangle. The information fields should be moveable and scalable.</p> <p><u>Orientation.</u> As determined by the anchor points.</p>	<p>020300ZDEC08 - 090500ZDEC08</p> 

TABLE H-XVIII. Target acquisition control measure symbols - Continued.

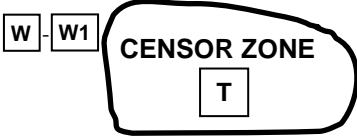
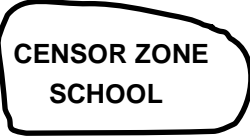
CONTROL MEASURE	TEMPLATE	DRAW RULES	EXAMPLE Note: The symbols that have been colored grey are used to help explain how the control measure is used, but they are not a part of the control measure.
<p>Censor Zone, Circular</p> <p>Symbol Set Code: 25 Code: 241303</p> <p>Static/Dynamic: D</p>		<p><u>Anchor Points.</u> This symbol requires one (1) anchor point and a radius. Point 1 defines the center point of the symbol.</p> <p><u>Size/Shape.</u> Size: The radius defines the size. Shape: Circle. The information fields should be scalable within the circle.</p> <p><u>Orientation.</u> Not applicable.</p>	<p>020300ZDEC08 - 090500ZDEC08</p> 
<p>Critical Friendly Zone (CFZ)</p> <p>Symbol Set Code: 25 Code: 241400</p>	<p>N/A</p>	<p>N/A</p>	<p>N/A</p>

TABLE H-XVIII. Target acquisition control measure symbols - Continued.

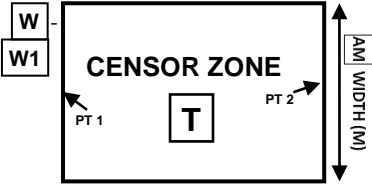

CONTROL MEASURE	TEMPLATE	DRAW RULES	EXAMPLE Note: The symbols that have been colored grey are used to help explain how the control measure is used, but they are not a part of the control measure.
<p>Critical Friendly Zone (CFZ), Irregular</p> <p>An area, usually a friendly unit or location that the maneuver commander designates as critical to the protection of an asset whose loss would seriously jeopardize the mission.</p> <p>Symbol Set Code: 25 Code: 241401</p> <p>Static/Dynamic: D</p>		<p><u>Anchor Points.</u> This symbol requires a minimum of three (3) and a maximum of six (6) anchor points to define the boundary of the area. The anchor points shall be sequentially numbered, in increments of one (1), beginning with point one (1).</p> <p><u>Size/Shape.</u> Determined by the anchor points. The information fields should be moveable and scalable within the area.</p> <p><u>Orientation.</u> Not applicable.</p>	<p>020300ZDEC08 - 090500ZDEC08</p> 

TABLE H-XVIII. Target acquisition control measure symbols - Continued.

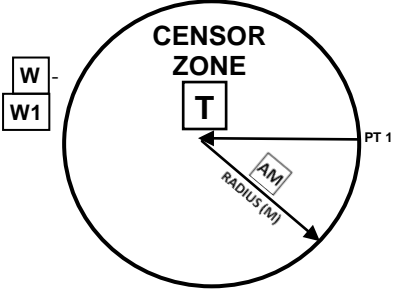
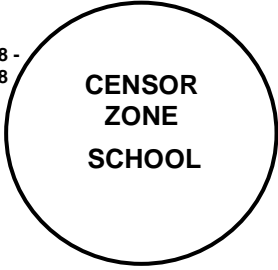

CONTROL MEASURE	TEMPLATE	DRAW RULES	EXAMPLE Note: The symbols that have been colored grey are used to help explain how the control measure is used, but they are not a part of the control measure.
<p>Critical Friendly Zone (CFZ), Rectangular</p> <p>Symbol Set Code: 25 Code: 241402</p> <p>Static/Dynamic: D</p>		<p><u>Anchor Points.</u> This symbol requires two anchor points and a width, defined in meters, to define the boundary of the area. Points 1 and 2 will be located in the center of two opposing sides of the rectangle.</p> <p><u>Size/Shape.</u> Size: As determined by the anchor points. The anchor points determine the length of the rectangle. The width, defined in meters, will determine the width of the rectangle.</p> <p>Shape: Rectangle. The information fields should be moveable and scalable.</p> <p><u>Orientation.</u> As determined by the anchor points.</p>	<p>020300ZDEC08 - 090500ZDEC08</p> 

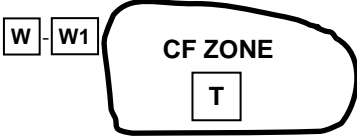
TABLE H-XVIII. Target acquisition control measure symbols - Continued.

CONTROL MEASURE	TEMPLATE	DRAW RULES	EXAMPLE Note: The symbols that have been colored grey are used to help explain how the control measure is used, but they are not a part of the control measure.
<p>Critical Friendly Zone (CFZ), Circular</p> <p>Symbol Set Code: 25 Code: 241403</p> <p>Static/Dynamic: D</p>		<p><u>Anchor Points.</u> This symbol requires one (1) anchor point and a radius. Point 1 defines the center point of the symbol.</p> <p><u>Size/Shape.</u> Size: The radius defines the size. Shape: Circle. The information fields should be scalable within the circle.</p> <p><u>Orientation.</u> Not applicable.</p>	<p>020300ZDEC08 - 090500ZDEC08</p> 
<p>Dead Space Area</p> <p>Symbol Set Code: 25 Code: 241500</p>	<p>N/A</p>		<p>N/A</p>

TABLE H-XVIII. Target acquisition control measure symbols - Continued.

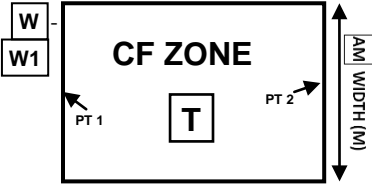
CONTROL MEASURE	TEMPLATE	DRAW RULES	EXAMPLE Note: The symbols that have been colored grey are used to help explain how the control measure is used, but they are not a part of the control measure.
<p>Dead Space Area, Irregular</p> <p>An area where hostile weapons cannot be detected.</p> <p>Symbol Set Code: 25 Code: 241501</p> <p>Static/Dynamic: D</p>		<p><u>Anchor Points.</u> This symbol requires a minimum of three (3) and a maximum of six (6) anchor points to define the boundary of the area. The anchor points shall be sequentially numbered, in increments of one (1), beginning with point one (1).</p> <p><u>Size/Shape.</u> Determined by the anchor points. The information fields should be moveable and scalable within the area.</p> <p><u>Orientation.</u> Not applicable.</p>	

TABLE H-XVIII. Target acquisition control measure symbols - Continued.

CONTROL MEASURE	TEMPLATE	DRAW RULES	EXAMPLE Note: The symbols that have been colored grey are used to help explain how the control measure is used, but they are not a part of the control measure.
<p>Dead Space Area, Rectangular</p> <p>Symbol Set Code: 25 Code: 241502</p> <p>Static/Dynamic: D</p>		<p><u>Anchor Points.</u> This symbol requires two anchor points and a width, defined in meters, to define the boundary of the area. Points 1 and 2 will be located in the center of two opposing sides of the rectangle.</p> <p><u>Size/Shape.</u> Size: As determined by the anchor points. The anchor points determine the length of the rectangle. The width, defined in meters, will determine the width of the rectangle.</p> <p>Shape: Rectangle. The information fields should be moveable and scalable.</p> <p><u>Orientation.</u> As determined by the anchor points.</p>	<p>060300ZNOV07 - 090500ZNOV07</p> 

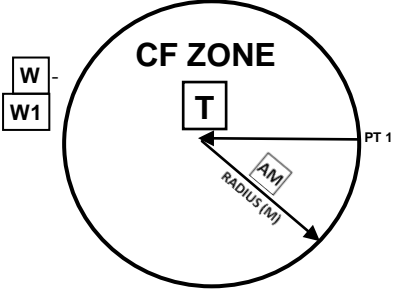
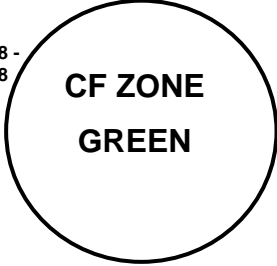
TABLE H-XVIII. Target acquisition control measure symbols - Continued.

CONTROL MEASURE	TEMPLATE	DRAW RULES	EXAMPLE Note: The symbols that have been colored grey are used to help explain how the control measure is used, but they are not a part of the control measure.
<p>Dead Space Area, Circular</p> <p>Symbol Set Code: 25 Code: 241503</p> <p>Static/Dynamic: D</p>		<p><u>Anchor Points.</u> This symbol requires one (1) anchor point and a radius. Point 1 defines the center point of the symbol.</p> <p><u>Size/Shape.</u> Size: The radius defines the size. Shape: Circle. The information fields should be scalable within the circle.</p> <p><u>Orientation.</u> Not applicable.</p>	<p>060300ZNOV07 - 090500ZNOV07</p> 
<p>Sensor Zone</p> <p>Symbol Set Code: 25 Code: 241600</p>	<p>N/A</p>		<p>N/A</p>

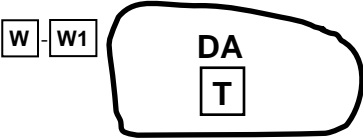
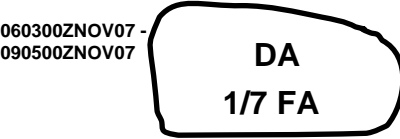
TABLE H-XVIII. Target acquisition control measure symbols - Continued.

CONTROL MEASURE	TEMPLATE	DRAW RULES	EXAMPLE Note: The symbols that have been colored grey are used to help explain how the control measure is used, but they are not a part of the control measure.
<p>Sensor Zone, Irregular</p> <p>Symbol Set Code: 25 Code: 241601</p> <p>Static/Dynamic: D</p>		<p><u>Anchor Points.</u> This symbol requires a minimum of three (3) and a maximum of six (6) anchor points to define the boundary of the area. The anchor points shall be sequentially numbered, in increments of one (1), beginning with point one (1).</p> <p><u>Size/Shape.</u> Determined by the anchor points. The information fields should be moveable and scalable within the area.</p> <p><u>Orientation.</u> Not applicable.</p>	

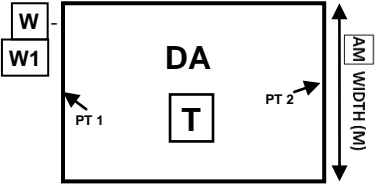
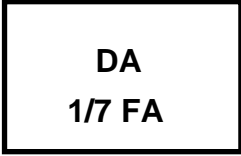
TABLE H-XVIII. Target acquisition control measure symbols - Continued.

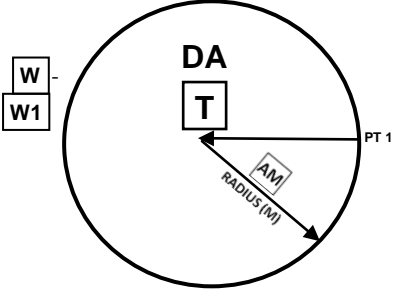
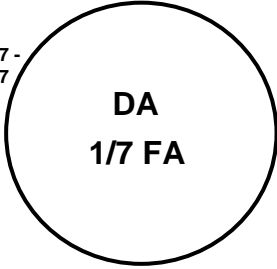

CONTROL MEASURE	TEMPLATE	DRAW RULES	EXAMPLE Note: The symbols that have been colored grey are used to help explain how the control measure is used, but they are not a part of the control measure.
<p>Sensor Zone, Rectangular</p> <p>Symbol Set Code: 25 Code: 241602</p> <p>Static/Dynamic: D</p>		<p><u>Anchor Points.</u> This symbol requires two anchor points and a width, defined in meters, to define the boundary of the area. Points 1 and 2 will be located in the center of two opposing sides of the rectangle.</p> <p><u>Size/Shape.</u> Size: As determined by the anchor points. The anchor points determine the length of the rectangle. The width, defined in meters, will determine the width of the rectangle.</p> <p>Shape: Rectangle. The information fields should be moveable and scalable.</p> <p><u>Orientation.</u> As determined by the anchor points.</p>	<p>020300ZDEC08 - 090500ZDEC08</p> 

TABLE H-XVIII. Target acquisition control measure symbols - Continued.

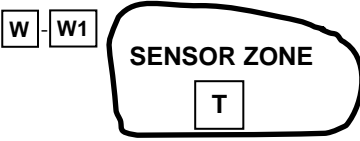
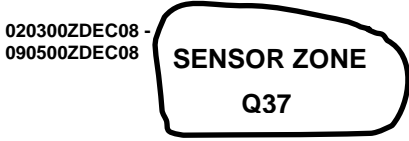
CONTROL MEASURE	TEMPLATE	DRAW RULES	EXAMPLE Note: The symbols that have been colored grey are used to help explain how the control measure is used, but they are not a part of the control measure.
<p>Sensor Zone, Circular</p> <p>Symbol Set Code: 25 Code: 241603</p> <p>Static/Dynamic: D</p>		<p><u>Anchor Points.</u> This symbol requires one (1) anchor point and a radius. Point 1 defines the center point of the symbol.</p> <p><u>Size/Shape.</u> Size: The radius defines the size. Shape: Circle. The information fields should be scalable within the circle.</p> <p><u>Orientation.</u> Not applicable.</p>	<p>020300ZDEC08 - 090500ZDEC08</p> 
<p>Target Build-up Area</p> <p>Symbol Set Code: 25 Code: 241700</p>	<p>N/A</p>		<p>N/A</p>

TABLE H-XVIII. Target acquisition control measure symbols - Continued.

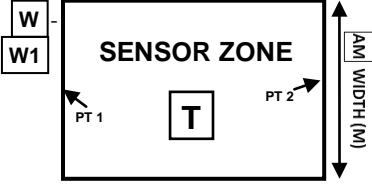

CONTROL MEASURE	TEMPLATE	DRAW RULES	EXAMPLE Note: The symbols that have been colored grey are used to help explain how the control measure is used, but they are not a part of the control measure.
<p>Target Build-up Area, Irregular</p> <p>Symbol Set Code: 25 Code: 241701</p> <p>Static/Dynamic: D</p>		<p><u>Anchor Points.</u> This symbol requires a minimum of three (3) and a maximum of six (6) anchor points to define the boundary of the area. The anchor points shall be sequentially numbered, in increments of one (1), beginning with point one (1).</p> <p><u>Size/Shape.</u> Determined by the anchor points. The information fields should be moveable and scalable within the area.</p> <p><u>Orientation.</u> Not applicable.</p>	<p>020300ZJUL08 - 090500ZJUL08</p> 

TABLE H-XVIII. Target acquisition control measure symbols - Continued.

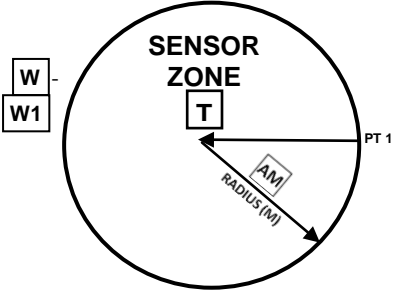
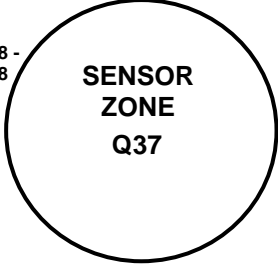

CONTROL MEASURE	TEMPLATE	DRAW RULES	EXAMPLE Note: The symbols that have been colored grey are used to help explain how the control measure is used, but they are not a part of the control measure.
<p>Target Build-up Area, Rectangular</p> <p>Symbol Set Code: 25 Code: 241702</p> <p>Static/Dynamic: D</p>		<p><u>Anchor Points.</u> This symbol requires two anchor points and a width, defined in meters, to define the boundary of the area. Points 1 and 2 will be located in the center of two opposing sides of the rectangle.</p> <p><u>Size/Shape.</u> Size: As determined by the anchor points. The anchor points determine the length of the rectangle. The width, defined in meters, will determine the width of the rectangle.</p> <p>Shape: Rectangle. The information fields should be moveable and scalable.</p> <p><u>Orientation.</u> As determined by the anchor points.</p>	<p>020300ZJUL08 - 090500ZJUL08</p> 

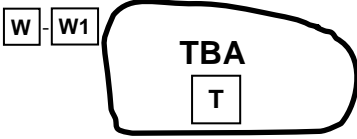
TABLE H-XVIII. Target acquisition control measure symbols - Continued.

CONTROL MEASURE	TEMPLATE	DRAW RULES	EXAMPLE Note: The symbols that have been colored grey are used to help explain how the control measure is used, but they are not a part of the control measure.
<p>Target Build-up Area, Circular</p> <p>Symbol Set Code: 25 Code: 241703</p> <p>Static/Dynamic: D</p>		<p><u>Anchor Points.</u> This symbol requires one (1) anchor point and a radius. Point 1 defines the center point of the symbol.</p> <p><u>Size/Shape.</u> Size: The radius defines the size. Shape: Circle. The information fields should be scalable within the circle.</p> <p><u>Orientation.</u> Not applicable.</p>	<p>020300ZJUL08 - 090500ZJUL08</p> 
<p>Target Value Area</p> <p>Symbol Set Code: 25 Code: 241800</p>	<p>N/A</p>		<p>N/A</p>

TABLE H-XVIII. Target acquisition control measure symbols - Continued.

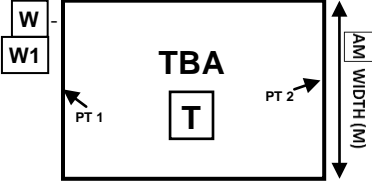
CONTROL MEASURE	TEMPLATE	DRAW RULES	EXAMPLE Note: The symbols that have been colored grey are used to help explain how the control measure is used, but they are not a part of the control measure.
<p>Target Value Area, Irregular</p> <p>Symbol Set Code: 25 Code: 241801</p> <p>Static/Dynamic: D</p>		<p><u>Anchor Points.</u> This symbol requires a minimum of three (3) and a maximum of six (6) anchor points to define the boundary of the area. The anchor points shall be sequentially numbered, in increments of one (1), beginning with point one (1).</p> <p><u>Size/Shape.</u> Determined by the anchor points. The information fields should be moveable and scalable within the area.</p> <p><u>Orientation.</u> Not applicable.</p>	

TABLE H-XVIII. Target acquisition control measure symbols - Continued.

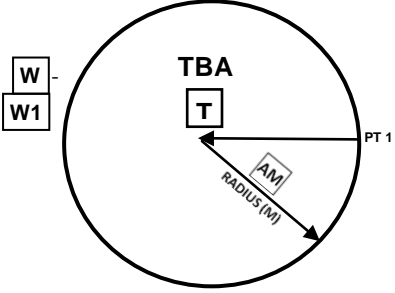
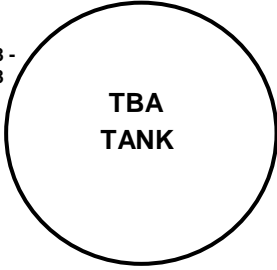

CONTROL MEASURE	TEMPLATE	DRAW RULES	EXAMPLE Note: The symbols that have been colored grey are used to help explain how the control measure is used, but they are not a part of the control measure.
<p>Target Value Area, Rectangular</p> <p>Symbol Set Code: 25 Code: 241802</p> <p>Static/Dynamic: D</p>		<p><u>Anchor Points.</u> This symbol requires two anchor points and a width, defined in meters, to define the boundary of the area. Points 1 and 2 will be located in the center of two opposing sides of the rectangle.</p> <p><u>Size/Shape.</u> Size: As determined by the anchor points. The anchor points determine the length of the rectangle. The width, defined in meters, will determine the width of the rectangle.</p> <p>Shape: Rectangle. The information fields should be moveable and scalable.</p> <p><u>Orientation.</u> As determined by the anchor points.</p>	<p>020300ZAPR08 - 090500ZAPR08</p> 

TABLE H-XVIII. Target acquisition control measure symbols - Continued.

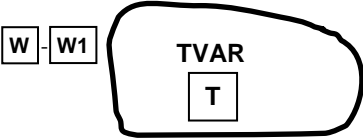
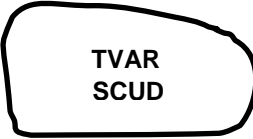
CONTROL MEASURE	TEMPLATE	DRAW RULES	EXAMPLE Note: The symbols that have been colored grey are used to help explain how the control measure is used, but they are not a part of the control measure.
<p>Target Value Area, Circular</p> <p>Symbol Set Code: 25 Code: 241803</p> <p>Static/Dynamic: D</p>		<p><u>Anchor Points.</u> This symbol requires one (1) anchor point and a radius. Point 1 defines the center point of the symbol.</p> <p><u>Size/Shape.</u> Size: The radius defines the size. Shape: Circle. The information fields should be scalable within the circle.</p> <p><u>Orientation.</u> Not applicable.</p>	<p>020300ZAPR08 - 090500ZAPR08</p> 
<p>Zone of Responsibility</p> <p>Symbol Set Code: 25 Code: 241900</p>	<p>N/A</p>		<p>N/A</p>

TABLE H-XVIII. Target acquisition control measure symbols - Continued.

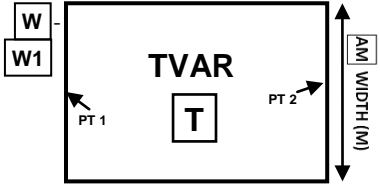
CONTROL MEASURE	TEMPLATE	DRAW RULES	EXAMPLE Note: The symbols that have been colored grey are used to help explain how the control measure is used, but they are not a part of the control measure.
<p>Zone of Responsibility, Irregular</p> <p>Symbol Set Code: 25 Code: 241901</p> <p>Static/Dynamic: D</p>		<p><u>Anchor Points.</u> This symbol requires a minimum of three (3) and a maximum of six (6) anchor points to define the boundary of the area. The anchor points shall be sequentially numbered, in increments of one (1), beginning with point one (1).</p> <p><u>Size/Shape.</u> Determined by the anchor points. The information fields should be moveable and scalable within the area.</p> <p><u>Orientation.</u> Not applicable.</p>	

TABLE H-XVIII. Target acquisition control measure symbols - Continued.

CONTROL MEASURE	TEMPLATE	DRAW RULES	EXAMPLE Note: The symbols that have been colored grey are used to help explain how the control measure is used, but they are not a part of the control measure.
<p>Zone of Responsibility, Rectangular</p> <p>Symbol Set Code: 25 Code: 241902</p> <p>Static/Dynamic: D</p>		<p><u>Anchor Points.</u> This symbol requires two anchor points and a width, defined in meters, to define the boundary of the area. Points 1 and 2 will be located in the center of two opposing sides of the rectangle.</p> <p><u>Size/Shape.</u> Size: As determined by the anchor points. The anchor points determine the length of the rectangle. The width, defined in meters, will determine the width of the rectangle.</p> <p>Shape: Rectangle. The information fields should be moveable and scalable.</p> <p><u>Orientation.</u> As determined by the anchor points.</p>	<p>020300ZMAY08 - 090500ZMAY08</p> <div style="border: 2px solid black; padding: 10px; text-align: center;"> <p>ZOR 3BDE 4ID</p> </div>

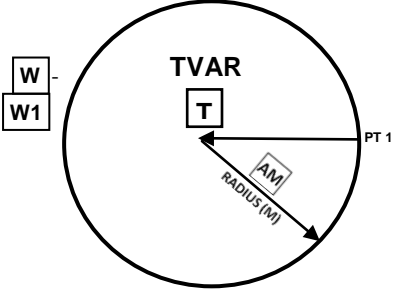
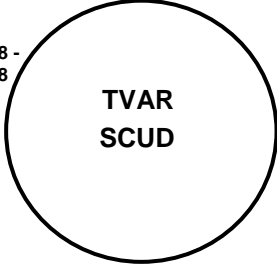
TABLE H-XVIII. Target acquisition control measure symbols - Continued.

CONTROL MEASURE	TEMPLATE	DRAW RULES	EXAMPLE Note: The symbols that have been colored grey are used to help explain how the control measure is used, but they are not a part of the control measure.
<p>Zone of Responsibility, Circular</p> <p>Symbol Set Code: 25 Code: 241903</p> <p>Static/Dynamic: D</p>		<p><u>Anchor Points.</u> This symbol requires one (1) anchor point and a radius. Point 1 defines the center point of the symbol.</p> <p><u>Size/Shape.</u> Size: The radius defines the size. Shape: Circle. The information fields should be scalable within the circle.</p> <p><u>Orientation.</u> Not applicable.</p>	<p>020300ZMAY08 - 090500ZMAY08</p> 

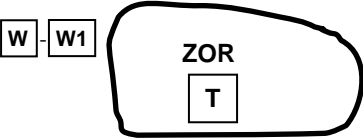
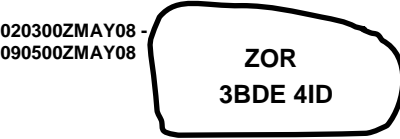
TABLE H-XVIII. Target acquisition control measure symbols - Continued.

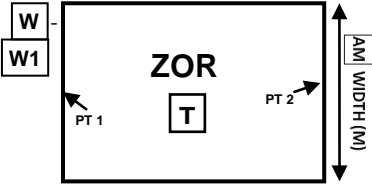

CONTROL MEASURE	TEMPLATE	DRAW RULES	EXAMPLE Note: The symbols that have been colored grey are used to help explain how the control measure is used, but they are not a part of the control measure.
<p>Terminally Guided Munition Footprint (TGMF)</p> <p>Symbol Set Code: 25 Code: 242000</p> <p>Static/Dynamic: D</p>		<p><u>Anchor Points.</u> This symbol requires a minimum of three (3) and a maximum of six (6) anchor points to define the boundary of the area. The anchor points shall be sequentially numbered, in increments of one (1), beginning with point one (1).</p> <p><u>Size/Shape.</u> Determined by the anchor points. The information fields should be moveable and scalable within the area.</p> <p><u>Orientation.</u> Not applicable.</p>	

TABLE H-XVIII. Target acquisition control measure symbols - Continued.

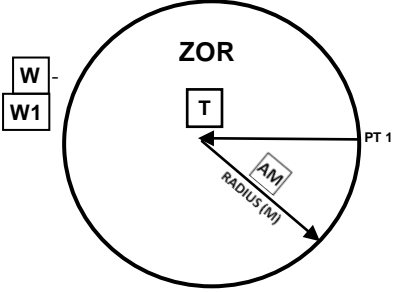
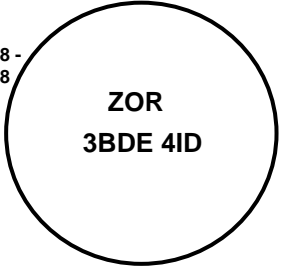
CONTROL MEASURE	TEMPLATE	DRAW RULES	EXAMPLE Note: The symbols that have been colored grey are used to help explain how the control measure is used, but they are not a part of the control measure.
<p>Weapon/Sensor Range fan, Circular</p> <p>Symbol Set Code: 25 Code: 242100</p> <p>Static/Dynamic: D</p>	 <p>The coordinate, which pinpoints the current physical location of a specific unit, weapon or acquisition system, may change with the movement of the object. The symbol for that object is located at the anchor point.</p>	<p><u>Anchor Points.</u> This symbol requires one anchor point that defines an object at a dynamic grid location.</p> <p><u>Size/Shape.</u> Shapes are concentric circles. Size is defined by the minimum and maximum ranges (as many as required) measured from the anchor point. All units in meters.</p> <p><u>Orientation.</u> The center point is typically centered over the known location of a weapon or target acquisition system. The orientation of the Circular Range Fan is the direction of engagement. The orientation may change as the object moves or changes.</p>	

TABLE H-XVIII. Target acquisition control measure symbols - Continued.

CONTROL MEASURE	TEMPLATE	DRAW RULES	EXAMPLE Note: The symbols that have been colored grey are used to help explain how the control measure is used, but they are not a part of the control measure.
<p>Weapon/Sensor Range fan, Sector</p> <p>Symbol Set Code: 25 Code: 242200</p> <p>Static/Dynamic: D</p>	 <p>CENTER OF SECTOR</p> <p>ANCHOR PT.</p> <p>RG AM3 ALT X3</p> <p>RG AM2 ALT X2</p> <p>RG AM1 ALT X1</p> <p>AN1 AN2 AN3 AN4 AN5 AN6 AN7</p> <p>This coordinate, which pinpoints the current physical location of a specific unit, weapon or acquisition system, may change with the movement of the object. The symbol for that object is located at the anchor point.</p>	<p><u>Anchor Points.</u> This symbol requires one anchor point that defines an object at a dynamic grid location.</p> <p><u>Size/Shape.</u> Determined from the anchor point with a single azimuth that denotes Sector Center. The maximum left and right limits of the sector are measured from the sector centerline. Multiple ranges and/or maximum left and right limits of the sector, as well as height, may be entered, as required, to define the sector. All ranges in meters.</p> <p><u>Orientation.</u> Center point is typically centered over the known location of a weapon or target acquisition system. The orientation may change as the object moves or changes.</p>	 <p>RG 5000 ALT GL</p> <p>RG 3500 ALT GL</p> <p>RG 2500 ALT GL</p> <p>RG 1500 ALT GL</p> <p>315 315 290 290 35 30 30 30</p>

TABLE H-XVIII. Target acquisition control measure symbols - Continued.

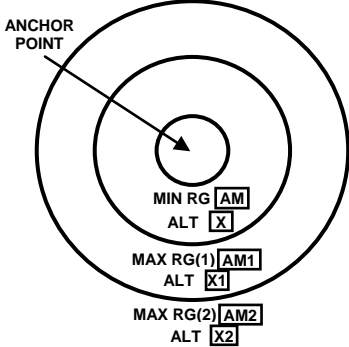
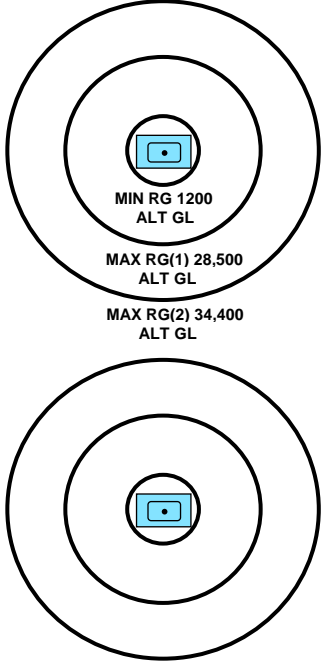

CONTROL MEASURE	TEMPLATE	DRAW RULES	EXAMPLE Note: The symbols that have been colored grey are used to help explain how the control measure is used, but they are not a part of the control measure.
<p>Kill Box</p> <p>Symbol Set Code: 25 Code: 242300</p> <p>Static/Dynamic: D</p>	<p>N/A</p>		<p>N/A</p>
<p>Blue Kill Box, Irregular</p> <p>Symbol Set Code: 25 Code: 242301</p> <p>Static/Dynamic: D</p>		<p><u>Anchor Points.</u> This symbol requires a minimum of three (3) and a maximum of six (6) anchor points to define the boundary of the area. The anchor points shall be sequentially numbered, in increments of one (1), beginning with point one (1). <u>Size/Shape.</u> Determined by the anchor points. The information fields should be moveable and scalable within the area. <u>Orientation.</u> Not applicable.</p>	<p>020300ZMAY08 - 090500ZMAY08</p> 

TABLE H-XVIII. Target acquisition control measure symbols - Continued.

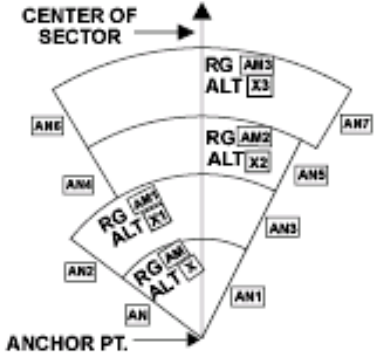
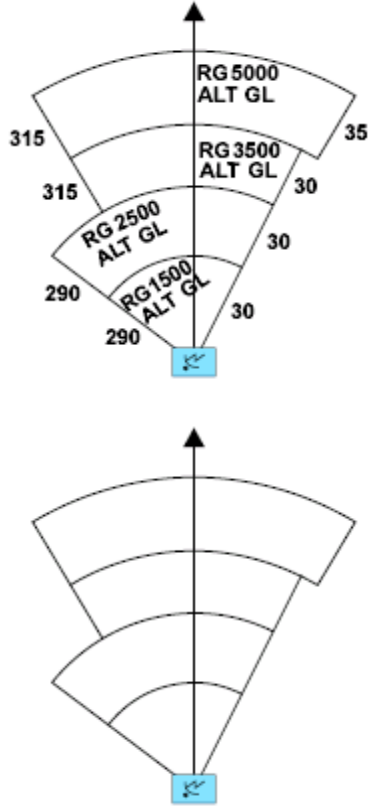

CONTROL MEASURE	TEMPLATE	DRAW RULES	EXAMPLE Note: The symbols that have been colored grey are used to help explain how the control measure is used, but they are not a part of the control measure.
<p>Blue Kill Box, Rectangular</p> <p>Symbol Set Code: 25 Code: 242302</p> <p>Static/Dynamic: D</p>		<p><u>Anchor Points.</u> This symbol requires two anchor points and a width, defined in meters, to define the boundary of the area. Points 1 and 2 will be located in the center of two opposing sides of the rectangle.</p> <p><u>Size/Shape.</u> Size: As determined by the anchor points. The anchor points determine the length of the rectangle. The width, defined in meters, will determine the width of the rectangle.</p> <p>Shape: Rectangle. The information fields should be moveable and scalable.</p> <p><u>Orientation.</u> As determined by the anchor points.</p>	<p>020300ZMAY08 - 090500ZMAY08</p> 

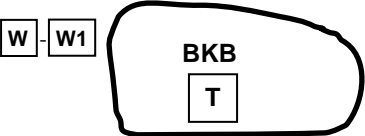
TABLE H-XVIII. Target acquisition control measure symbols - Continued.

CONTROL MEASURE	TEMPLATE	DRAW RULES	EXAMPLE Note: The symbols that have been colored grey are used to help explain how the control measure is used, but they are not a part of the control measure.
<p>Blue Kill Box, Circular</p> <p>Symbol Set Code: 25 Code: 242303</p> <p>Static/Dynamic: D</p>		<p><u>Anchor Points.</u> This symbol requires one(1) anchor point and a radius. Point 1 defines the center point of the symbol.</p> <p><u>Size/Shape.</u> Size: The radius defines the size. Shape: Circle. The information fields should be scalable within the circle.</p> <p><u>Orientation.</u> Not applicable.</p>	<p>020300ZMAY08 - 090500ZMAY08</p> 
<p>Purple Kill Box, Irregular</p> <p>Symbol Set Code: 25 Code: 242304</p> <p>Static/Dynamic: D</p>		<p><u>Anchor Points.</u> This symbol requires a minimum of three (3) and a maximum of six (6) anchor points to define the boundary of the area. The anchor points shall be sequentially numbered, in increments of one (1), beginning with point one (1).</p> <p><u>Size/Shape.</u> Determined by the anchor points. The information fields should be moveable and scalable within the area.</p> <p><u>Orientation.</u> Not applicable.</p>	<p>020300ZMAY08 - 090500ZMAY08</p> 

TABLE H-XVIII. Target acquisition control measure symbols - Continued.

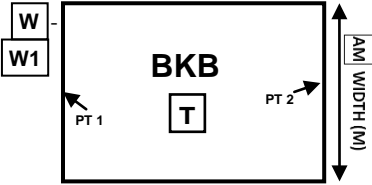

CONTROL MEASURE	TEMPLATE	DRAW RULES	EXAMPLE Note: The symbols that have been colored grey are used to help explain how the control measure is used, but they are not a part of the control measure.
<p>Purple Kill Box, Rectangular</p> <p>Symbol Set Code: 25 Code: 242305</p> <p>Static/Dynamic: D</p>		<p><u>Anchor Points.</u> This symbol requires two anchor points and a width, defined in meters, to define the boundary of the area. Points 1 and 2 will be located in the center of two opposing sides of the rectangle.</p> <p><u>Size/Shape.</u> Size: As determined by the anchor points. The anchor points determine the length of the rectangle. The width, defined in meters, will determine the width of the rectangle.</p> <p>Shape: Rectangle. The information fields should be moveable and scalable.</p> <p><u>Orientation.</u> As determined by the anchor points.</p>	<p>020300ZMAY08 - 090500ZMAY08</p> 

TABLE H-XVIII. Target acquisition control measure symbols - Continued.

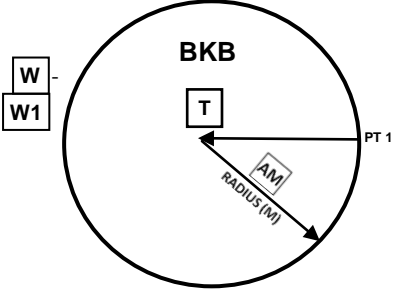
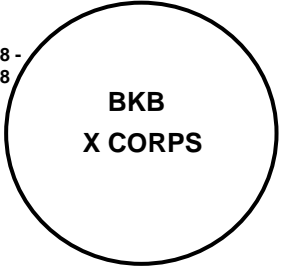
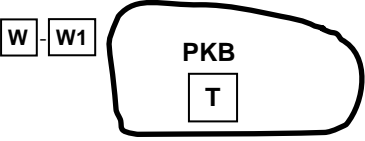
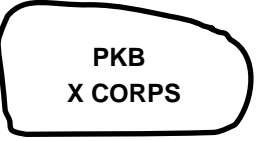
CONTROL MEASURE	TEMPLATE	DRAW RULES	EXAMPLE Note: The symbols that have been colored grey are used to help explain how the control measure is used, but they are not a part of the control measure.
<p>Purple Kill Box, Circular</p> <p>Symbol Set Code: 25 Code: 242306</p> <p>Static/Dynamic: D</p>		<p><u>Anchor Points.</u> This symbol requires one (1) anchor point and a radius. Point 1 defines the center point of the symbol.</p> <p><u>Size/Shape.</u> Size: The radius defines the size. Shape: Circle. The information fields should be scalable within the circle.</p> <p><u>Orientation.</u> Not applicable.</p>	<p>020300ZMAY08 - 090500ZMAY08</p> 

H.5.21 Obstacles.

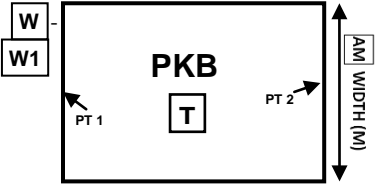
H.5.21.1 Obstacles. Natural or man-made restrictions to movement which will impose delay and which will normally require specific equipment or munitions to overcome. (AAP-19). Obstacles are normally shown in green. If color is not available, they are to be shown in black. Regardless of whether green or black is used for color, ENY must be used. If red is used, the ENY may be omitted.

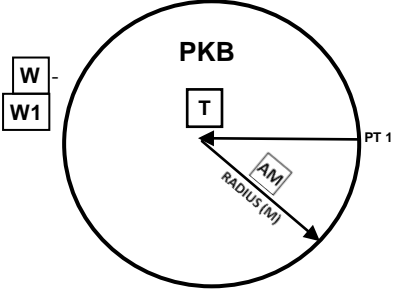
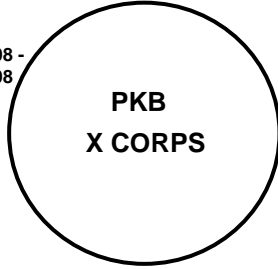
TABLE H-XIX. Obstacle control measure symbols.

CONTROL MEASURE	TEMPLATE	DRAW RULES	EXAMPLE Note: The symbols that have been colored grey are used to help explain how the control measure is used, but they are not a part of the control measure.
<p>Protection Areas</p> <p>Symbol Set Code: 25 Code: 270000</p>	<p>N/A</p>		<p>N/A</p>

TABLE H-XIX. Obstacle control measure symbols - Continued.



CONTROL MEASURE	TEMPLATE	DRAW RULES	EXAMPLE Note: The symbols that have been colored grey are used to help explain how the control measure is used, but they are not a part of the control measure.
<p>Obstacle Belt</p> <p>An area designated at brigade level in which barrier operations are focused. (AAP-19)</p> <p>Symbol Set Code: 25 Code: 270100</p>		<p><u>Anchor Points:</u> This symbol requires at least three anchor points to define the boundary of the area. Add as many points as necessary to accurately reflect the area's size and shape.</p> <p><u>Size/Shape:</u> Determined by the anchor points. The information fields should be moveable and scalable as a block within the area.</p> <p><u>Orientation:</u> Not applicable.</p> <p>Static/ Dynamic: D</p>	
<p>Obstacle Zone</p> <p>An area designated at corps or division level in which barrier operations are focused. It may be subdivided, below division, into a number of obstacle belts. (AAP-19)</p> <p>Symbol Set Code: 25 Code: 270200</p>		<p>Static/ Dynamic: D</p>	
<p>Obstacle Free Zone</p> <p>Symbol Set Code: 25 Code: 270300</p>			

TABLE H-XIX. Obstacle control measure symbols - Continued.

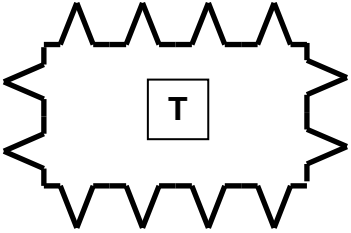
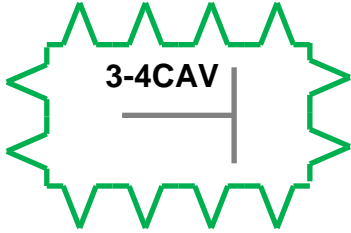
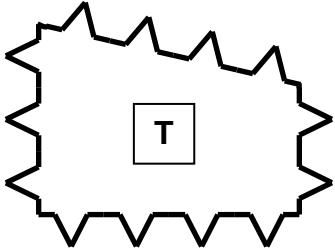
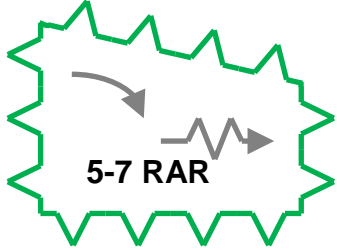
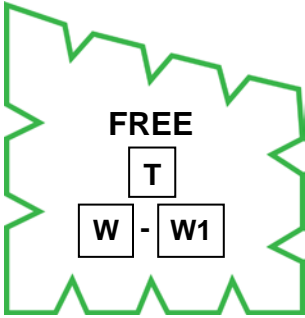

CONTROL MEASURE	TEMPLATE	DRAW RULES	EXAMPLE Note: The symbols that have been colored grey are used to help explain how the control measure is used, but they are not a part of the control measure.
Obstacle Restricted Zone Symbol Set Code: 25 Code: 270400			
Obstacle Effects Symbol Set Code: 25 Code: 270500	N/A		N/A

TABLE H-XIX. Obstacle control measure symbols - Continued.

CONTROL MEASURE	TEMPLATE	DRAW RULES	EXAMPLE Note: The symbols that have been colored grey are used to help explain how the control measure is used, but they are not a part of the control measure.
<p>Block</p> <p>An obstacle effect that integrates fire planning and obstacle effort to stop an attacker along a specific avenue of approach or to prevent him from passing through an engagement area.</p> <p>Symbol Set Code: 25 Code: 270501</p> <p>Static/ Dynamic: D</p>	 <p>The horizontal line is the limit of the enemy advance. The vertical line indicates where obstacles tie in to terrain that is untrafficable.</p>	<p><u>Anchor Points.</u> This symbol requires three anchor points. Points 1 and 2 define the endpoints of the symbol's vertical line. Point 3 defines the endpoint of the symbol's horizontal line.</p> <p><u>Size/Shape.</u> Points 1 and 2 determine the length of the vertical line. The length of the horizontal line is determined by plotting point 3 on a plane extending perpendicularly from the midpoint of the vertical line.</p> <p><u>Orientation.</u> The head of the "T" typically faces enemy forces.</p>	

TABLE H-XIX. Obstacle control measure symbols - Continued.

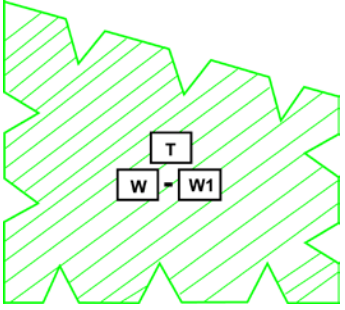
CONTROL MEASURE	TEMPLATE	DRAW RULES	EXAMPLE Note: The symbols that have been colored grey are used to help explain how the control measure is used, but they are not a part of the control measure.
<p>Disrupt</p> <p>An obstacle effect that focuses fire planning and obstacle effort to cause the enemy to break up his formation and tempo, interrupt his timetable, commit breaching assets prematurely and attack in a piecemeal effort.</p> <p>Symbol Set Code: 25 Code: 270502</p> <p>Static/ Dynamic: D</p>	 <p>Short arrow indicates where enemy is disrupted by obstacles. Longer arrows indicate where movement is allowed and enemy is attacked by fires.</p>	<p><u>Anchor Points:</u> This symbol requires three anchor points. Points 1 and 2 define the end points of the symbol's vertical line. Point 3 defines the tip of the longest arrow. Point 3 determines its length. The spacing between the symbol's arrows will stay proportional to the symbol's vertical line. The length of the short arrows will remain in proportion to the length of the longest arrow.</p> <p><u>Size/Shape:</u> Points 1 and 2 determine the height of the symbol and point 3 determines its length. The spacing between the symbol's arrows will stay proportional to the symbol's vertical line. The length of the short arrows will remain in proportion to the length of the longest arrow.</p> <p><u>Orientation:</u> The arrows point away from enemy forces.</p>	

TABLE H-XIX. Obstacle control measure symbols - Continued.

CONTROL MEASURE	TEMPLATE	DRAW RULES	EXAMPLE Note: The symbols that have been colored grey are used to help explain how the control measure is used, but they are not a part of the control measure.
<p>Fix</p> <p>An obstacle effect that focuses fire planning and obstacle effort to slow an attacker's movement within a specified area, normally an engagement area.</p> <p>Symbol Set Code: 25 Code: 270503</p> <p>Static/ Dynamic: D</p>	 <p>Note: From the tip of the arrow to the back of the irregular part of the symbol indicates where enemy advance is slowed by obstacles.</p>	<p><u>Anchor Points:</u> This symbol requires 2 anchor points. Point 1 defines the tip of the arrowhead and point 2 defines the rear of the symbol.</p> <p><u>Size/Shape:</u> Points 1 and 2 determine the length of the symbol, which varies only in length.</p> <p><u>Orientation:</u> The orientation is determined by the anchor points.</p>	

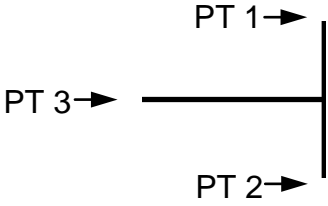
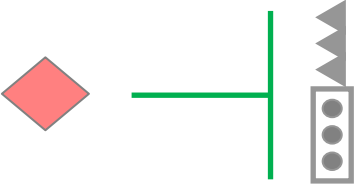
TABLE H-XIX. Obstacle control measure symbols - Continued.

CONTROL MEASURE	TEMPLATE	DRAW RULES	EXAMPLE Note: The symbols that have been colored grey are used to help explain how the control measure is used, but they are not a part of the control measure.
<p>Turn</p> <p>An obstacle effect that integrates fire planning and obstacle effort to drive an enemy formation from one avenue of approach to an adjacent avenue of approach or into an engagement area.</p> <p>Symbol Set Code: 25 Code: 270504</p> <p>Static/ Dynamic: D</p>	 <p>Note: Direction of the arrow indicates the desired direction of turn.</p>	<p><u>Anchor Points:</u> This symbol requires two anchor points. Point 1 defines the rear of the symbol. Point 2 defines the tip of the arrowhead. Point 3 defines the 90 degree arc.</p> <p><u>Size/Shape:</u> Points 1 and 2 are connected by a 90 degree arc. Point 3 indicates on which side of the line the arc is placed.</p> <p><u>Orientation:</u> The rear of the symbol identifies the enemy's location and the arrow points in the direction the obstacle should force the enemy to turn.</p>	
<p>Obstacle Bypass</p> <p>Symbol Set Code: 25 Code: 270600</p>	<p>N/A</p>	<p>N/A</p>	<p>N/A</p>

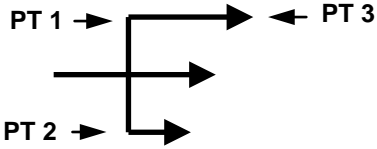
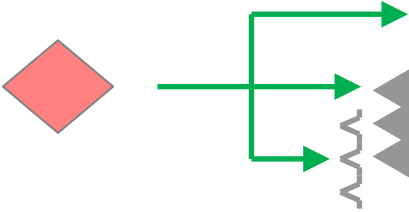
TABLE H-XIX. Obstacle control measure symbols - Continued.



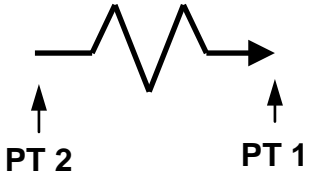
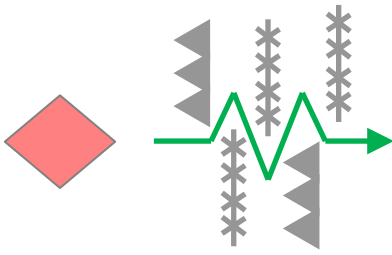

CONTROL MEASURE	TEMPLATE	DRAW RULES	EXAMPLE Note: The symbols that have been colored grey are used to help explain how the control measure is used, but they are not a part of the control measure.
<p>Obstacle Bypass Easy</p> <p>Symbol Set Code: 25 Code: 270601</p> <p>Static/ Dynamic: D</p>		<p><u>Anchor Points.</u> This symbol requires three anchor points. Points 1 and 2 define the tips of the arrowheads and point 3 defines the rear of the symbol.</p>	
<p>Obstacle Bypass Difficult</p> <p>Symbol Set Code: 25 Code: 270602</p> <p>Static/ Dynamic: D</p>		<p><u>Size/Shape.</u> Points 1 and 2 determine the symbol's height and point 3 determines its length. The vertical line at the rear of the symbol will be the same length as the opening.</p>	
<p>Obstacle Bypass Impossible</p> <p>Symbol Set Code: 25 Code: 270603</p> <p>Static/ Dynamic: D</p>		<p><u>Orientation.</u> The opening typically faces enemy forces.</p>	
<p>Bridge or Gap</p> <p>An area within a minefield or obstacle belt, free of live mines or obstacles, whose width and direction will allow a friendly force to pass through in tactical formation.</p> <p>Symbol Set Code: 25 Code: 271100</p>		<p><u>Anchor Points.</u> This symbol requires four points. Points 1 and 2 define one side of the gap and points 3 and 4 define the opposite side of the gap.</p> <p><u>Size/Shape.</u> Determined by the anchor points.</p> <p><u>Orientation.</u> Not applicable.</p> <p>Static/ Dynamic: D</p>	

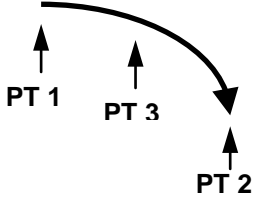
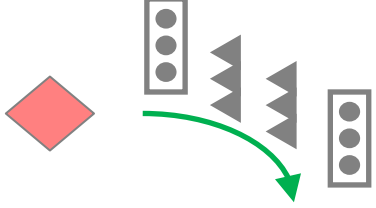
TABLE H-XIX. Obstacle control measure symbols - Continued.

CONTROL MEASURE	TEMPLATE	DRAW RULES	EXAMPLE Note: The symbols that have been colored grey are used to help explain how the control measure is used, but they are not a part of the control measure.
<p>Roadblocks, Craters and Blown Bridges</p> <p>Crater obstacle – An obstacle consisting of one or more craters, created normally in a roadway using demolitions.</p> <p>Symbol Set Code: 25 Code: 271200</p>	<p>N/A</p>		<p>N/A</p>
<p>Planned</p> <p>Symbol Set Code: 25 Code: 271201</p>		<p><u>Anchor Points.</u> This symbol requires three anchor points. Points 1 and 2 define the endpoints of the symbol and point 3 defines the location of one side of the symbol.</p>	
<p>Explosives, State of Readiness 1 (Safe)</p> <p>Symbol Set Code: 25 Code: 271202</p>		<p><u>Size/Shape.</u> Points 1 and 2 determine the centerline of the symbol and point 3 determines its width.</p> <p><u>Orientation.</u> Orientation is determined by the anchor points.</p>	

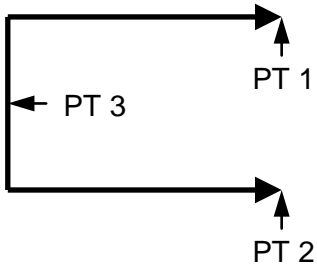
TABLE H-XIX. Obstacle control measure symbols - Continued.

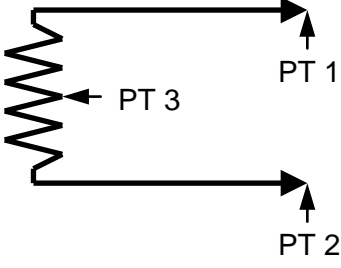
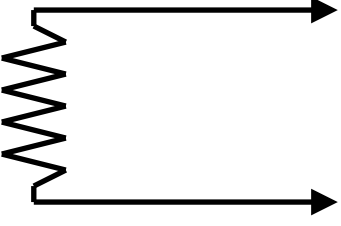
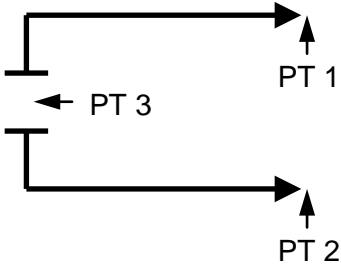
CONTROL MEASURE	TEMPLATE	DRAW RULES	EXAMPLE Note: The symbols that have been colored grey are used to help explain how the control measure is used, but they are not a part of the control measure.
<p>Explosives, State of Readiness 2 (armed but passable)</p> <p>Symbol Set Code: 25 Code: 271203</p>		<p>Static/ Dynamic: D</p>	
<p>Roadblock Complete (Executed)</p> <p>Symbol Set Code: 25 Code: 271204</p>			
<p>Protection Points</p> <p>Symbol Set Code: 25 Code: 280000</p>	<p>N/A</p>		<p>N/A</p>

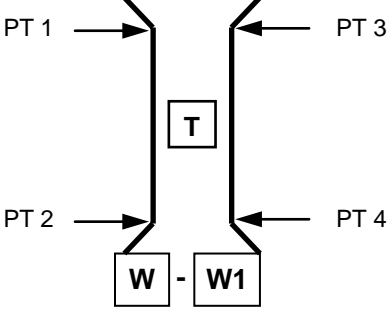
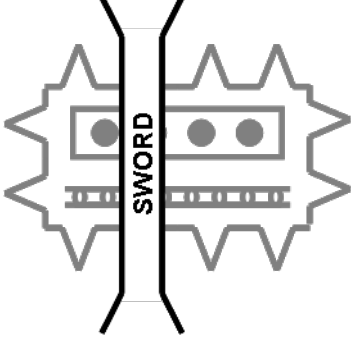
TABLE H-XIX. Obstacle control measure symbols - Continued.

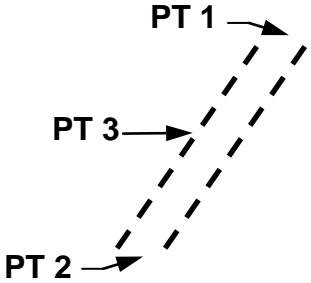
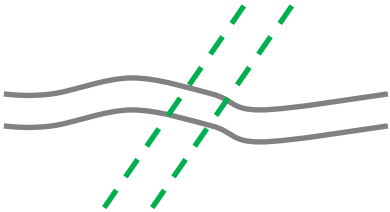
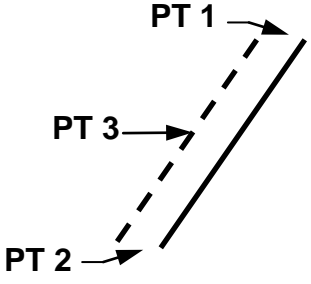
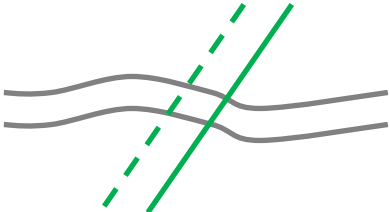

CONTROL MEASURE	TEMPLATE	DRAW RULES	EXAMPLE Note: The symbols that have been colored grey are used to help explain how the control measure is used, but they are not a part of the control measure.
<p>Abatis</p> <p>An obstacle constructed by the felling and interlacing of trees across a route. (AAP-19)</p> <p>Symbol Set Code: 25 Code: 280100</p> <p>Static/ Dynamic: D</p>		<p><u>Anchor Points.</u> This symbol requires at least two anchor points, points 1 and 2, to define the line. Additional points can be defined to extend the line.</p> <p><u>Size/Shape.</u> The first and last anchor points determine the length of the line. The size of the tooth does not change.</p> <p><u>Orientation.</u> Orientation is determined by the anchor points.</p>	
<p>Protection Lines</p> <p>Symbol Set Code: 25 Code: 290000</p>	<p>N/A</p>		<p>N/A</p>

TABLE H-XIX. Obstacle control measure symbols - Continued.

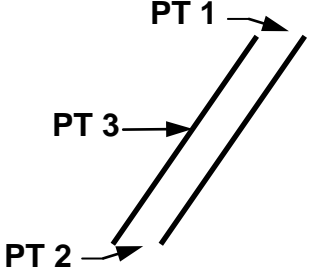
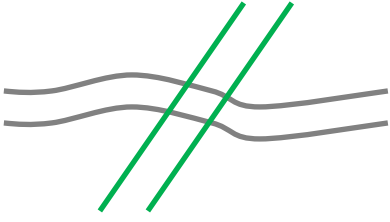
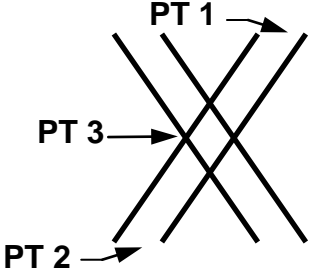
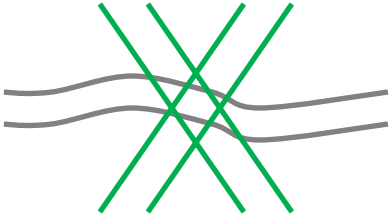

CONTROL MEASURE	TEMPLATE	DRAW RULES	EXAMPLE Note: The symbols that have been colored grey are used to help explain how the control measure is used, but they are not a part of the control measure.
<p>Obstacle Line</p> <p>A conceptual control measure used at battalion or brigade level to show placement intent without specifying a particular type of linear obstacle.</p> <p>Symbol Set Code: 25 Code: 290100</p> <p>Static/ Dynamic: D</p>		<p><u>Anchor Points.</u> This symbol requires at least two anchor points, points 1 and 2, to define the line. Additional points can be defined to extend the line.</p> <p><u>Size/Shape.</u> The first and last anchor points determine the length of the line.</p> <p><u>Orientation.</u> Orientation is determined by the order in which the anchor points are entered.</p>	
<p>Antitank Obstacles</p> <p>A ditch which is impassable to vehicles unaided. It may be prepared using machinery or explosives.</p> <p>Symbol Set Code: 25 Code: 290200</p>	<p>N/A</p>	<p>N/A</p>	<p>N/A</p>

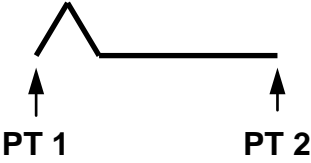
TABLE H-XIX. Obstacle control measure symbols - Continued.

CONTROL MEASURE	TEMPLATE	DRAW RULES	EXAMPLE Note: The symbols that have been colored grey are used to help explain how the control measure is used, but they are not a part of the control measure.
<p>Antitank Ditch – Under Construction</p> <p>Symbol Set Code: 25 Code: 290201</p> <p>Static/ Dynamic: D</p>		<p><u>Anchor Points.</u> This symbol requires at least two anchor points, points 1 and 2, to define the line. Additional points can be defined to extend the line.</p> <p><u>Size/Shape.</u> The first and last anchor points determine the length of the line.</p>	
<p>Antitank Ditch – Completed</p> <p>Symbol Set Code: 25 Code: 290202</p> <p>Static/ Dynamic: D</p>		<p><u>Orientation.</u> Orientation is determined by the order in which the anchor points are entered.</p> <p>Note: The teeth point toward enemy forces.</p>	

TABLE H-XIX. Obstacle control measure symbols - Continued.

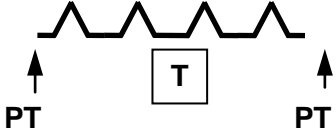

CONTROL MEASURE	TEMPLATE	DRAW RULES	EXAMPLE Note: The symbols that have been colored grey are used to help explain how the control measure is used, but they are not a part of the control measure.
<p>Antitank Ditch Reinforced, with Antitank Mines</p> <p>Symbol Set Code: 25 Code: 290203</p> <p>Static/ Dynamic: D</p>		<p><u>Anchor Points.</u> This graphic requires at least two anchor points, points 1 and 2, to define the line. Additional points can be defined to extend the line.</p> <p><u>Size/Shape.</u> The first and last anchor points determine the length of the line.</p> <p><u>Orientation.</u> Orientation is determined by the anchor points. The teeth typically point toward enemy forces.</p>	

TABLE H-XIX. Obstacle control measure symbols - Continued.

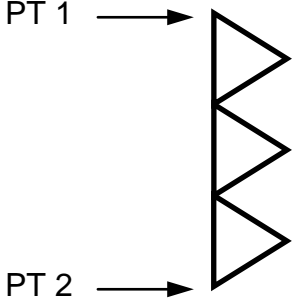
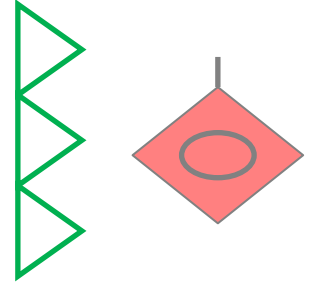
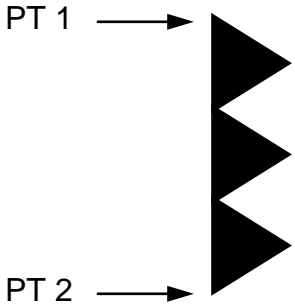
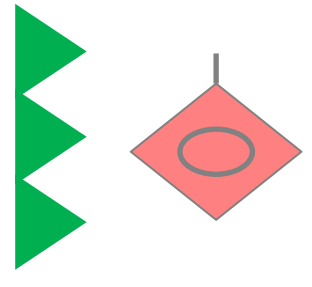

CONTROL MEASURE	TEMPLATE	DRAW RULES	EXAMPLE Note: The symbols that have been colored grey are used to help explain how the control measure is used, but they are not a part of the control measure.
<p>Antitank Wall</p> <p>Symbol Set Code: 25 Code: 290204</p> <p>Static/ Dynamic: D</p>		<p><u>Anchor Points.</u> This graphic requires at least two anchor points, points 1 and 2, to define the line. Additional points can be defined to extend the line.</p> <p><u>Size/Shape.</u> The first and last anchor points determine the length of the line.</p> <p><u>Orientation.</u> Orientation is determined by the anchor points. The teeth typically point toward enemy forces.</p>	
<p>Wire Obstacles</p> <p>Symbol Set Code: 25 Code: 290300</p>	<p>N/A</p>		<p>N/A</p>
<p>Unspecified</p> <p>Symbol Set Code: 25 Code: 290301</p>		<p><u>Anchor Points.</u> This symbol requires at least two anchor points, points 1 and 2, to define the line. Additional points can be defined to extend the line.</p>	
<p>Single Fence</p> <p>Symbol Set Code: 25 Code: 290302</p>		<p>Additional points can be defined to extend the line.</p>	
<p>Double Fence</p> <p>Symbol Set Code: 25 Code: 290303</p>		<p><u>Size/Shape.</u> The first and last anchor points</p>	

TABLE H-XIX. Obstacle control measure symbols - Continued.



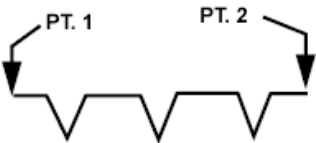
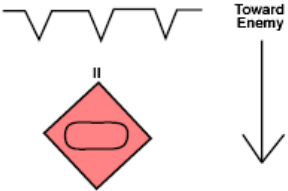

CONTROL MEASURE	TEMPLATE	DRAW RULES	EXAMPLE Note: The symbols that have been colored grey are used to help explain how the control measure is used, but they are not a part of the control measure.
Double Apron Fence Symbol Set Code: 25 Code: 290304		determine the length of the line. <u>Orientation.</u> Orientation is determined by the order in which the anchor points are entered.	
Low Wire Fence Symbol Set Code: 25 Code: 290305		Static/ Dynamic: D	
High Wire Fence Symbol Set Code: 25 Code: 290306			
Single Concertina Symbol Set Code: 25 Code: 290307			
Double Strand Concertina Symbol Set Code: 25 Code: 290308			
Triple Strand Concertina Symbol Set Code: 25 Code: 290309			

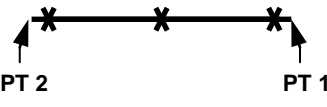
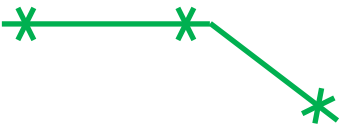
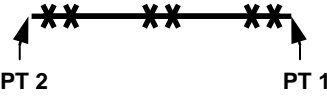
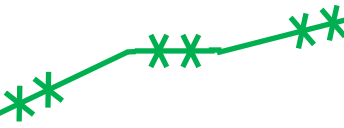
TABLE H-XIX. Obstacle control measure symbols - Continued.

CONTROL MEASURE	TEMPLATE	DRAW RULES	EXAMPLE Note: The symbols that have been colored grey are used to help explain how the control measure is used, but they are not a part of the control measure.
<p>Lane</p> <p>A route through an enemy or friendly obstacle that provides a passing force safe passage.</p> <p>Symbol Set Code: 25 Code: 290600</p> <p>Static/ Dynamic: D</p>		<p><u>Anchor Points.</u> This symbol requires two anchor points. Points 1 and 2 define the tips of the arrowheads.</p> <p><u>Size/Shape.</u> Points 1 and 2 determine the length of the symbol, which varies only in length. The lines of the arrowhead will form an acute angle.</p> <p><u>Orientation.</u> Orientation is determined by the anchor points.</p>	
<p>Land Mines</p> <p>In land mine warfare, an explosive ammunition designed to be placed under, on or near the ground or other surface area and to be actuated by the presence, proximity or contact of a person, land vehicle, aircraft or boat, including landing craft.</p>			
<p>Minefield</p> <p>In land mine warfare, a defined area in which mines have been emplaced.</p> <p>Symbol Set Code: 25 Code: 270700</p>	<p>N/A</p>		<p>N/A</p>

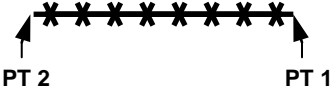
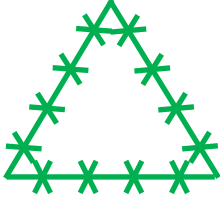
TABLE H-XIX. Obstacle control measure symbols - Continued.

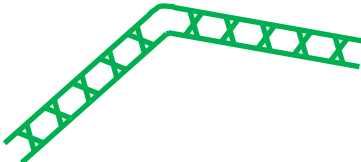
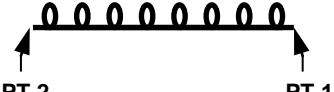
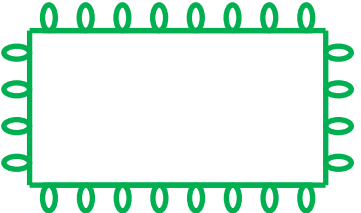
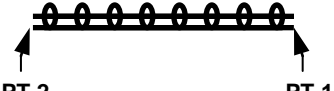
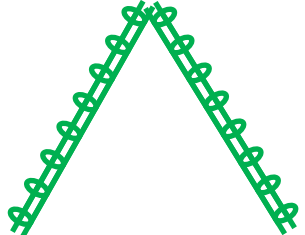
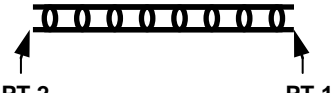
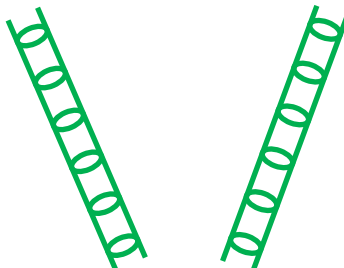

CONTROL MEASURE	TEMPLATE	DRAW RULES	EXAMPLE Note: The symbols that have been colored grey are used to help explain how the control measure is used, but they are not a part of the control measure.
<p>Completed Minefield</p> <p>Symbol Set Code: 25 Code: 270701</p>		<p><u>Anchor Points:</u> This symbol requires one anchor point. The center point defines/is the center of the symbol.</p> <p><u>Size/Shape:</u> Static.</p>	<p>+S</p> 
<p>Planned Minefield</p> <p>Symbol Set Code: 25 Code: 270702</p>		<p><u>Orientation:</u> The symbol is typically centered over the desired location.</p> <p>Note: The A field (graphics) will be filled with the type of mine(s) contained in the minefield (see mine types listed in this appendix). If only scatterable mines are within the minefield, the H field will be filled with an "S"; a "+S" will be used if there is a mix of scatterable and other mines as appropriate and</p>	<p>S</p> 
<p>Known Enemy Minefield</p> <p>Symbol Set Code: 25 Code: 270703</p>			
<p>Suspected or Templated Enemy Minefield</p> <p>Symbol Set Code: 25 Code: 270704</p>			

TABLE H-XIX. Obstacle control measure symbols - Continued.

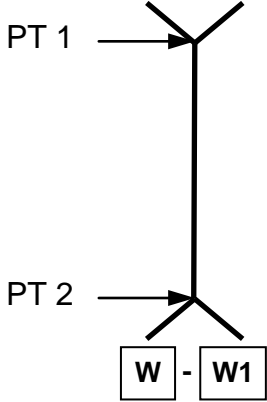
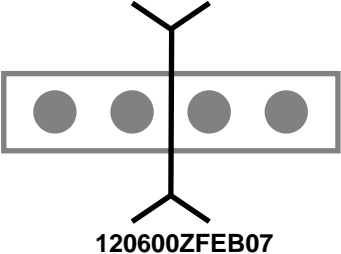
CONTROL MEASURE	TEMPLATE	DRAW RULES	EXAMPLE Note: The symbols that have been colored grey are used to help explain how the control measure is used, but they are not a part of the control measure.
<p>Dummy Minefield</p> <p>Symbol Set Code: 25 Code: 270705</p>		<p>a self-destruct time will be posted in the W field for the scatterable mines. If an offset location indicator is used with this symbol, the indicator will point to the center of mass of the minefield.</p> <p>Static/ Dynamic: S</p>	
<p>Dummy Minefield, Dynamic</p> <p>Symbol Set Code: 25 Code: 270706</p>			

TABLE H-XIX. Obstacle control measure symbols - Continued.

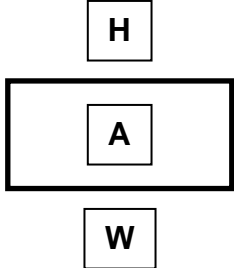
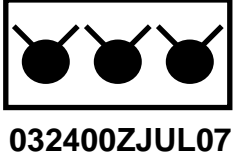
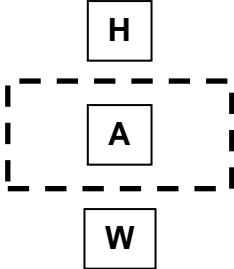
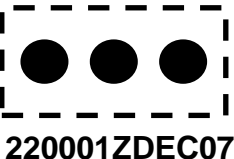
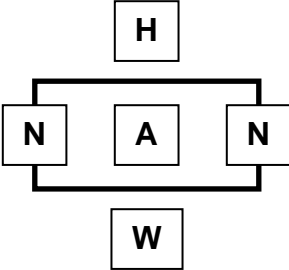
CONTROL MEASURE	TEMPLATE	DRAW RULES	EXAMPLE Note: The symbols that have been colored grey are used to help explain how the control measure is used, but they are not a part of the control measure.
<p>Dynamic Depiction</p> <p>Symbol Set Code: 25 Code: 270707</p> <p>Static/ Dynamic: D</p>		<p><u>Anchor Points.</u> This symbol requires at least three anchor points to define the boundary of the area.</p> <p><u>Size/Shape.</u> Determined by the anchor points. The symbol will be filled with the type of mine(s) contained in the minefield (see mine types listed in this appendix). If scatterable mines are within the minefield, the H field will be filled with an “S” or a “+S” as appropriate, and a self-destruct time will be posted in the W field.</p> <p><u>Orientation.</u> Not applicable.</p>	

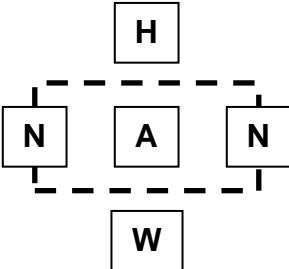
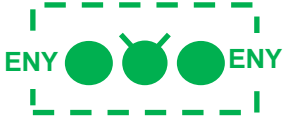
TABLE H-XIX. Obstacle control measure symbols - Continued.

CONTROL MEASURE	TEMPLATE	DRAW RULES	EXAMPLE Note: The symbols that have been colored grey are used to help explain how the control measure is used, but they are not a part of the control measure.
<p>Mined Area</p> <p>An area which is dangerous because of the presence or suspected presence of mines.</p> <p>Symbol Set Code: 25 Code: 270800</p>	 <p>Note: The A field (graphics) will be filled with the type of mine(s) contained in the minefield (see mine types listed in this appendix). If only scatterable mines are within the minefield, the H field will be filled with an “S”; a “+S” will be used if there is a mix of scatterable and other mines as appropriate and a self-destruct time will be posted in the W field for the scatterable mines. If an offset location indicator is used with this symbol, the indicator will point to the center of mass of the minefield.</p>	<p><u>Anchor Points:</u> This symbol requires at least three anchor points to define the boundary of the area. Add as many points as necessary to accurately reflect the area’s size and shape.</p> <p><u>Size/Shape:</u> Determined by the anchor points. The information fields should be moveable and scalable as a block within the area.</p> <p><u>Orientation:</u> Not applicable.</p>	
<p>Decoy Mined Area</p> <p>Symbol Set Code: 25 Code: 270900</p>	 <p>Note: The A field (graphics) will be filled with the type of mine(s) contained in the minefield (see mine types listed in this appendix). If only scatterable mines are within the minefield, the H field will be filled with an “S”; a “+S” will be used if there is a mix of scatterable and other mines as appropriate and a self-destruct time will be posted in the W field for the scatterable mines. If an offset location indicator is used with this symbol, the indicator will point to the center of mass of the minefield.</p>	<p>Static/ Dynamic: D</p>	

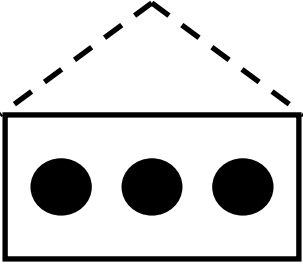
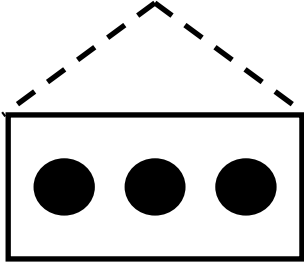
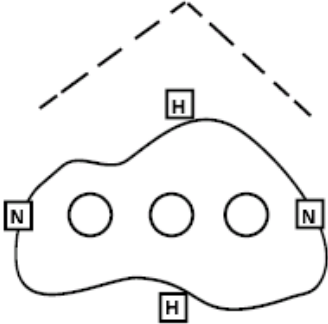
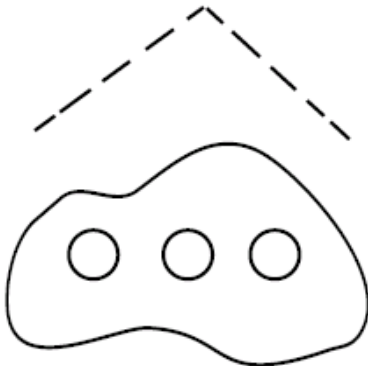
TABLE H-XIX. Obstacle control measure symbols - Continued.

CONTROL MEASURE	TEMPLATE	DRAW RULES	EXAMPLE Note: The symbols that have been colored grey are used to help explain how the control measure is used, but they are not a part of the control measure.
<p>Decoy Mined Area, Fenced</p> <p>Symbol Set Code: 25 Code: 270901</p>			
<p>Unexploded Explosive Ordnance (UXO) Area</p> <p>Symbol Set Code: 25 Code: 271000</p>			
<p>Antipersonnel Mine</p> <p>In land mine warfare, a mine designed to be exploded by the presence, proximity or contact of a person and that will incapacitate, wound or kill one or more persons. (AAP-19)</p> <p>Symbol Set Code: 25 Code: 280200</p>		<p><u>Anchor Points.</u> This symbol requires one anchor point. The center point defines/is the center of the symbol.</p> <p><u>Size/Shape.</u> Static.</p> <p><u>Orientation.</u> The symbol is typically centered over the desired location.</p> <p>Static/ Dynamic: S</p>	

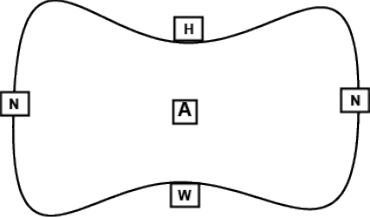
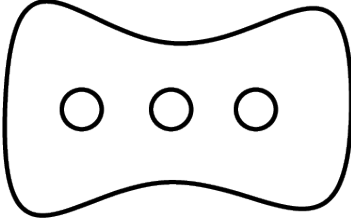
TABLE H-XIX. Obstacle control measure symbols - Continued.

CONTROL MEASURE	TEMPLATE	DRAW RULES	EXAMPLE Note: The symbols that have been colored grey are used to help explain how the control measure is used, but they are not a part of the control measure.
<p>Antipersonnel Mine with Directional Effects</p> <p>Symbol Set Code: 25 Code: 280201</p>	 <p>CENTER POINT</p>		
<p>Antitank Mine</p> <p>A mine designed to immobilize or destroy a tank. (AAP-19)</p> <p>Symbol Set Code: 25 Code: 280300</p>	 <p>CENTER POINT</p>		
<p>Antitank Mine with Anti-handling Device</p> <p>A device intended to protect a mine and which is part of, linked to, attached to or placed under the mine and which activates when an attempt is made to tamper with or otherwise intentionally disturb the mine. (AAP-19)</p> <p>Symbol Set Code: 25 Code: 280400</p>	 <p>CENTER POINT</p>		

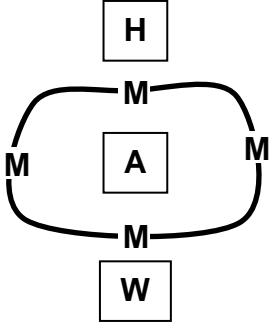
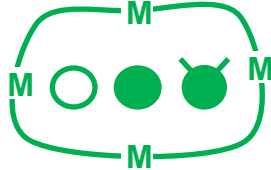
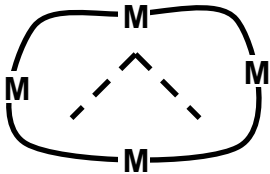
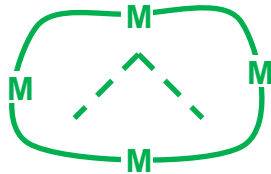
TABLE H-XIX. Obstacle control measure symbols - Continued.

CONTROL MEASURE	TEMPLATE	DRAW RULES	EXAMPLE Note: The symbols that have been colored grey are used to help explain how the control measure is used, but they are not a part of the control measure.
<p>Wide Area Antitank Mine</p> <p>An antitank mine that detects and acquires then launches subammunition that attacks the top of the targets.</p> <p>Symbol Set Code: 25 Code: 280500</p>			
<p>Unspecified Mine</p> <p>Symbol Set Code: 25 Code: 280600</p>			
<p>Booby Trap</p> <p>A device designed, constructed or adapted to kill or injure, which functions when a person disturbs or approaches an apparently harmless object or performs an apparently safe act.</p> <p>Symbol Set Code: 25 Code: 280700</p>		<p><u>Anchor Points.</u> This symbol requires one anchor point. The center point defines the center of the oval.</p> <p><u>Size/Shape.</u> Static.</p> <p><u>Orientation.</u> The symbol is typically centered over the desired location.</p> <p>Static/ Dynamic: S</p>	

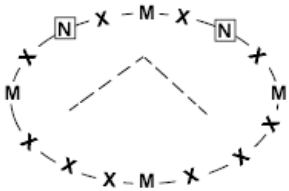
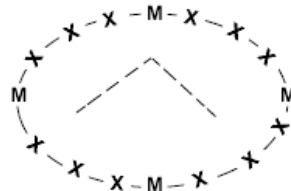
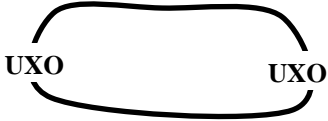
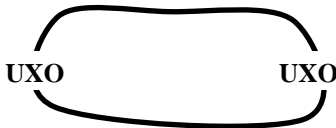
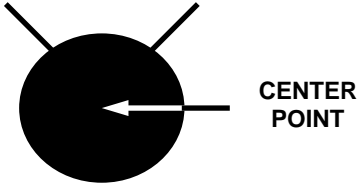
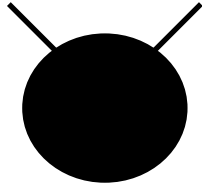
TABLE H-XIX. Obstacle control measure symbols - Continued.



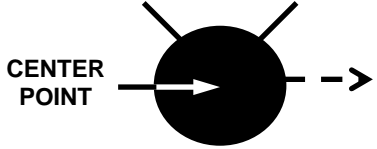
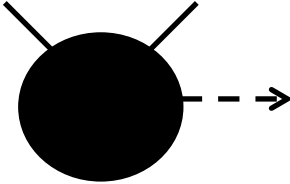
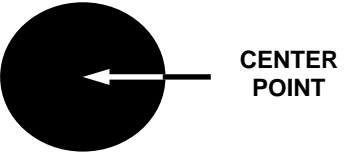
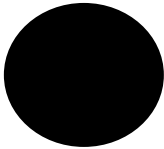
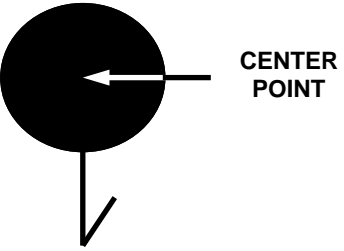
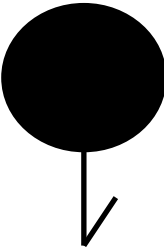

CONTROL MEASURE	TEMPLATE	DRAW RULES	EXAMPLE Note: The symbols that have been colored grey are used to help explain how the control measure is used, but they are not a part of the control measure.
Tetrahedrons, Dragons Teeth, and Other Similar Obstacles Symbol Set Code: 25 Code: 281900	N/A	<u>Anchor Points.</u> This symbol requires one anchor point. The anchor point defines the midpoint of the symbol's base. <u>Size/Shape.</u>	N/A
Fixed and Prefabricated Symbol Set Code: 25 Code: 281901		Static. <u>Orientation.</u> The symbol will typically be oriented upright, as shown in the example to the right, but will be rotatable in 90 degree increments.	
Movable Symbol Set Code: 25 Code: 281902		Static/ Dynamic: S	
Movable and Prefabricated Symbol Set Code: 25 Code: 281903			

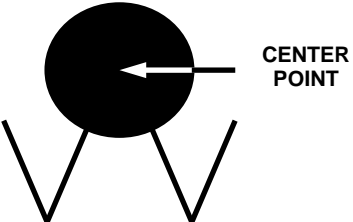
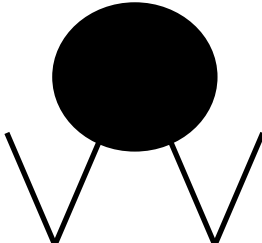
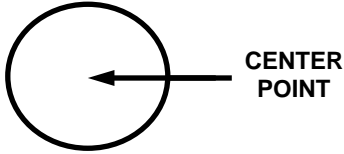
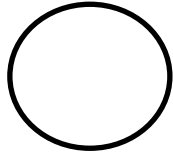
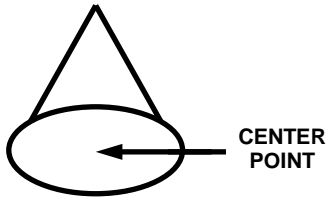
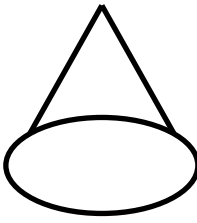
TABLE H-XIX. Obstacle control measure symbols - Continued.

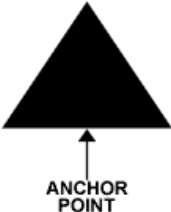

CONTROL MEASURE	TEMPLATE	DRAW RULES	EXAMPLE Note: The symbols that have been colored grey are used to help explain how the control measure is used, but they are not a part of the control measure.
<p>Mine Cluster</p> <p>Symbol Set Code: 25 Code: 290400</p>		<p><u>Anchor Points.</u> This symbol requires at least two anchor points. Points 1 and 2 define the corners of the symbol.</p> <p><u>Size/Shape.</u> Points 1 and 2 determine the length of the straight line. The radius of the semicircle is ½ the length of the straight line.</p> <p><u>Orientation.</u> Not applicable.</p> <p>Note: The dashed lines in this symbol shall be displayed in present and anticipated status.</p>	

TABLE H-XIX. Obstacle control measure symbols - Continued.

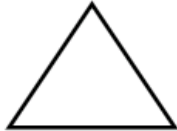
CONTROL MEASURE	TEMPLATE	DRAW RULES	EXAMPLE Note: The symbols that have been colored grey are used to help explain how the control measure is used, but they are not a part of the control measure.
<p>Trip Wire</p> <p>Symbol Set Code: 25 Code: 290500</p> <p>Static/ Dynamic: D</p>		<p><u>Anchor Points.</u> This symbol requires three anchor points. Points 1 and 2 define the vertical straight line portion of the symbol. Point 3 defines an end of the horizontal line.</p> <p><u>Size/Shape.</u> Points 1 and 2 determine the length of the vertical, straight-line portion of the symbol and point 3 determines its width. The distance between the line connecting points 1 and 2 and point 3 is the radius of the 90 degree arc at the bottom of the symbol.</p> <p><u>Orientation.</u> Orientation is determined by the anchor points.</p>	
<p>Vertical Obstructions</p> <p>Symbol Set Code: 25 Code: 282000</p>	<p>N/A</p>		<p>N/A</p>

TABLE H-XIX. Obstacle control measure symbols - Continued.

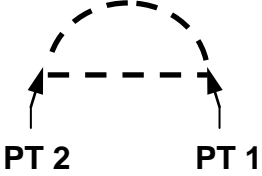

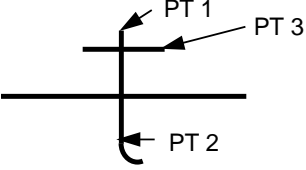
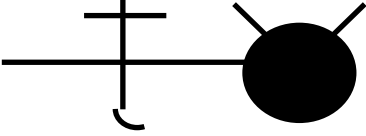

CONTROL MEASURE	TEMPLATE	DRAW RULES	EXAMPLE Note: The symbols that have been colored grey are used to help explain how the control measure is used, but they are not a part of the control measure.
<p>Tower, Low</p> <p>Symbol Set Code: 25 Code: 282001</p> <p>Static/ Dynamic: D</p> <p>Note: Towers less than 1000 Ft AGL</p>		<p><u>Anchor Points.</u> This symbol requires one anchor point; the point defines the circle at the base of the tower.</p> <p><u>Size/Shape.</u> The symbol is a high-angle cone.</p>	
<p>Tower, High</p> <p>Symbol Set Code: 25 Code: 282002</p> <p>Static/ Dynamic: D</p> <p>Note: Towers 1000 Ft and Higher AGL</p>		<p><u>Orientation.</u> The symbol will remain upright.</p>	

TABLE H-XIX. Obstacle control measure symbols - Continued.

CONTROL MEASURE	TEMPLATE	DRAW RULES	EXAMPLE Note: The symbols that have been colored grey are used to help explain how the control measure is used, but they are not a part of the control measure.
<p>Overhead Wire</p> <p>Symbol Set Code: 25 Code: 282003</p> <p>Static/ Dynamic: D</p>	<p>For use on maps of all scales</p> 	<p><u>Anchor Points.</u> This graphic requires at least two anchor points, points 1 and 2, to define the line. Additional points can be defined to extend the line.</p> <p><u>Size/Shape.</u> The first and last anchor points determine the length of the line.</p> <p><u>Orientation.</u> Orientation is determined by the anchor points.</p>	
<p>Water Crossing Site</p> <p>The location of a single bridge or rafting site, or in an initial assault a site for the crossing of assault boats or for the swimming or fording of vehicles on a broad front.</p>			
<p>Assault Crossing</p> <p>Symbol Set Code: 25 Code: 271300</p> <p>Static/ Dynamic: D</p>		<p><u>Anchor Points.</u> This symbol requires four points. Points 1 and 2 define one side of the assault crossing site and points 3 and 4 define the opposite side of the assault crossing site.</p> <p><u>Size/Shape.</u> Determined by the anchor points.</p> <p><u>Orientation.</u> Not applicable.</p>	

TABLE H-XIX. Obstacle control measure symbols - Continued.

CONTROL MEASURE	TEMPLATE	DRAW RULES	EXAMPLE Note: The symbols that have been colored grey are used to help explain how the control measure is used, but they are not a part of the control measure.
<p>Bridge</p> <p>Symbol Set Code: 25 Code: 271400</p>		<p><u>Anchor Points.</u> This symbol requires three anchor points. Points 1 and 2 define the endpoints of the first line. Point 3 defines the location of the parallel line.</p> <p><u>Size/Shape.</u> Points 1 and 2 determine the length of the symbol. Point 3 determines its width.</p> <p><u>Orientation.</u> Orientation is determined by the anchor points.</p>	
<p>Ford Easy</p> <p>Symbol Set Code: 25 Code: 271500</p>		<p>Static/ Dynamic: D</p>	
<p>Ford Difficult</p> <p>Symbol Set Code: 25 Code: 271600</p>			

TABLE H-XIX. Obstacle control measure symbols - Continued.

CONTROL MEASURE	TEMPLATE	DRAW RULES	EXAMPLE Note: The symbols that have been colored grey are used to help explain how the control measure is used, but they are not a part of the control measure.
<p>Engineer Regulating Point</p> <p>Checkpoint to ensure that vehicles do not exceed the capacity of the crossing means and to give drivers final instructions on site-specific procedures and information, such as speed and vehicle interval.</p> <p>Symbol Set Code: 25 Code: 280800</p>		<p><u>Anchor Points.</u> This symbol requires one anchor point. The point defines/is the tip of the inverted cone.</p> <p><u>Size/Shape.</u> Static.</p> <p><u>Orientation.</u> The symbol will typically be oriented upright.</p> <p>Static/ Dynamic: S</p>	
<p>Ferry</p> <p>Symbol Set Code: 25 Code: 290700</p> <p>Static/ Dynamic: D</p>		<p><u>Anchor Points.</u> This symbol requires two anchor points. Points 1 and 2 define the tips of the arrowheads.</p> <p><u>Size/Shape.</u> Points 1 and 2 determine the length of the symbol, which varies only in length. The arrowheads will be filled-in versions of a common arrowhead.</p> <p><u>Orientation.</u> Orientation is determined by the anchor points.</p>	

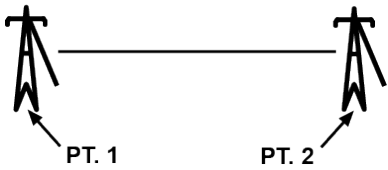
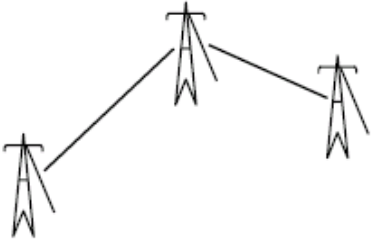
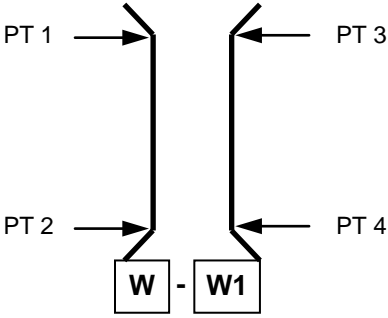
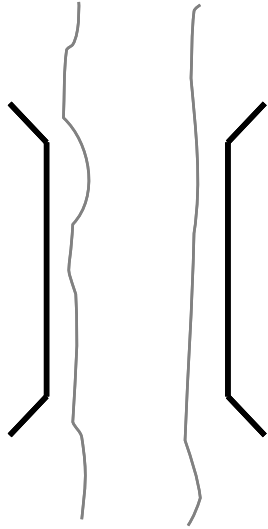
TABLE H-XIX. Obstacle control measure symbols - Continued.

CONTROL MEASURE	TEMPLATE	DRAW RULES	EXAMPLE Note: The symbols that have been colored grey are used to help explain how the control measure is used, but they are not a part of the control measure.
<p>Raft Site</p> <p>Symbol Set Code: 25 Code: 290800</p> <p>Static/ Dynamic: D</p>		<p><u>Anchor Points.</u> This symbol requires two anchor points. Points 1 and 2 define the tips of the arrowheads.</p> <p><u>Size/Shape.</u> Points 1 and 2 determine the length of the symbol, which varies only in length. The lines of the arrowhead will form an acute angle.</p> <p><u>Orientation.</u> Orientation is determined by the anchor points.</p>	

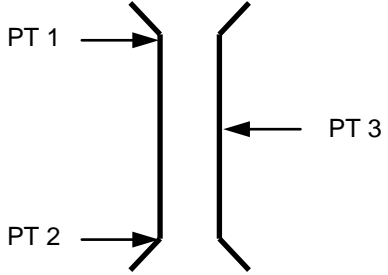
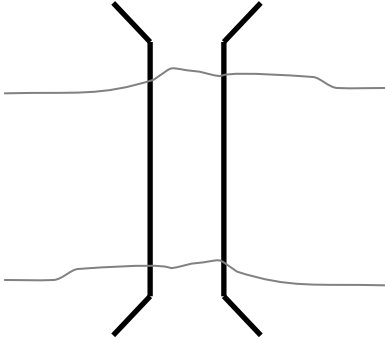
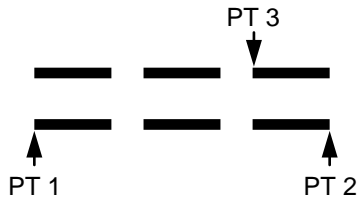
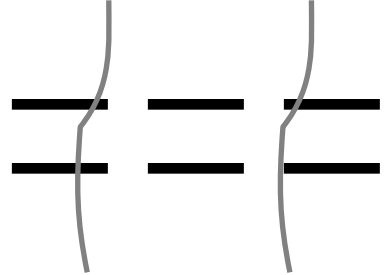
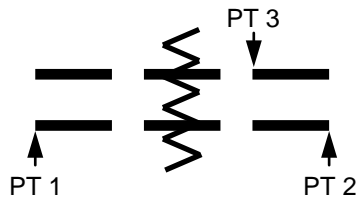
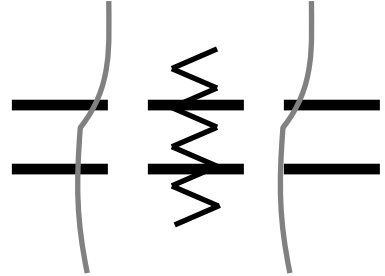
H.5.22 Field fortification control measures.

H.5.22.1 Field fortification. Is an emplacement or shelter of a temporary nature which can be constructed with reasonable facility by units requiring no more than minor engineer supervisory and equipment participation.

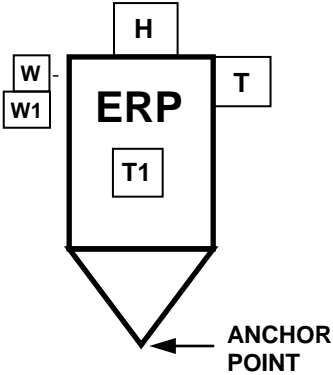
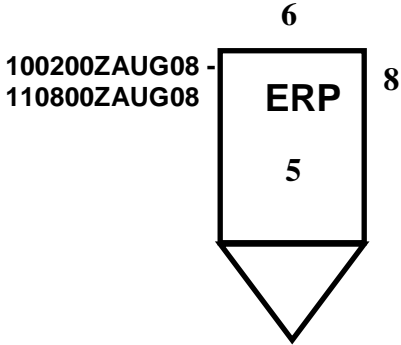
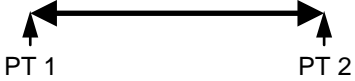
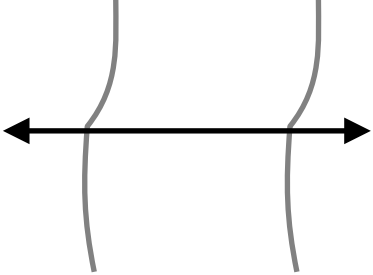
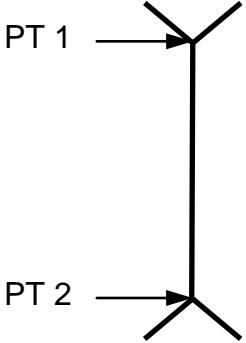
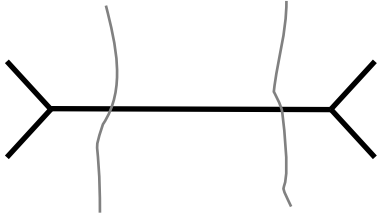
TABLE H-XX. Field fortification control measure symbols.



CONTROL MEASURE	TEMPLATE	DRAW RULES	EXAMPLE Note: The symbols that have been colored grey are used to help explain how the control measure is used, but they are not a part of the control measure.
<p>Shelter</p> <p>Symbol Set Code: 25 Code: 280900</p>		<p><u>Anchor Points.</u> This symbol requires one anchor point. The center point defines</p>	

TABLE H-XX. Field fortification control measure symbols - Continued.







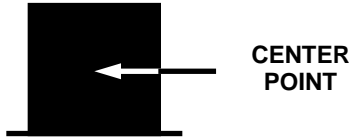

CONTROL MEASURE	TEMPLATE	DRAW RULES	EXAMPLE Note: The symbols that have been colored grey are used to help explain how the control measure is used, but they are not a part of the control measure.
Above Ground Shelter Symbol Set Code: 25 Code: 281000		the center of the symbol. <u>Size/Shape.</u> Static. <u>Orientation.</u> The symbol is typically centered over the desired location.	
Below Ground Shelter Symbol Set Code: 25 Code: 281100		Static/ Dynamic: S	
Fort Symbol Set Code: 25 Code: 281200			

TABLE H-XX. Field fortification control measure symbols - Continued.

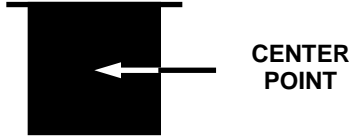
CONTROL MEASURE	TEMPLATE	DRAW RULES	EXAMPLE Note: The symbols that have been colored grey are used to help explain how the control measure is used, but they are not a part of the control measure.
<p>Fortified Line</p> <p>Symbol Set Code: 25 Code: 290900</p> <p>Static/ Dynamic: D</p>	 <p>Note: The ramparts typically point toward enemy forces.</p>	<p><u>Anchor Points.</u> This symbol requires at least two anchor points, points 1 and 2, to define the line. Additional points can be defined to extend the line.</p> <p><u>Size/Shape.</u> The first and last anchor points determine the length of the line.</p> <p><u>Orientation.</u> Orientation is determined by the anchor points.</p>	
<p>Fortified Position</p> <p>Symbol Set Code: 25 Code: 291000</p> <p>Static/ Dynamic: D</p>	 <p>Note: The symbol typically faces enemy forces.</p>	<p><u>Anchor Points.</u> This symbol requires two anchor points. Points 1 and 2 define the corners on the front of the symbol.</p> <p><u>Size/Shape.</u> Points 1 and 2 determine the length of the symbol, which varies only in length.</p> <p><u>Orientation.</u> Orientation is determined by the anchor points.</p>	

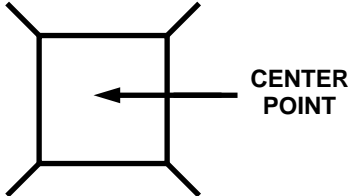
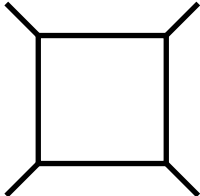
H.5.23 CBRN defense control measure symbols.

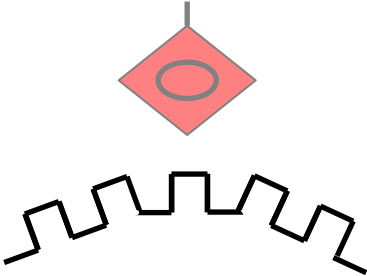
H.5.23.1 CBRN defense. These control measure symbols depict those conditions found in an area resulting from immediate or persisting effects of chemical, biological, radiological or nuclear attacks or events (release other than attack).

TABLE H-XXI. CBRN defense control measure symbols.

CONTROL MEASURE	TEMPLATE	DRAW RULES	EXAMPLE Note: The symbols that have been colored grey are used to help explain how the control measure is used, but they are not a part of the control measure.
<i>Contaminated Areas</i>			
Biological Contaminated Area Symbol Set Code: 25 Code: 271700		<u>Anchor Points.</u> This symbol requires at least three anchor points to define the boundary of the area. Add as many points as necessary to accurately reflect the area's size and shape.	
Biological Contaminated Area – Toxic Industrial Material Symbol Set Code: 25 Code: 271701		<u>Size/Shape.</u> Determined by the anchor points. The symbol should be moveable and scalable as a block within the area.	
Chemical Contaminated Area Symbol Set Code: 25 Code: 271800		<u>Orientation.</u> Not applicable.	
Chemically Contaminated Area – Toxic Industrial Material Symbol Set Code: 25 Code: 271801		Static/ Dynamic: D	

TABLE H-XXI. CBRN defense control measure symbols - Continued.

CONTROL MEASURE	TEMPLATE	DRAW RULES	EXAMPLE Note: The symbols that have been colored grey are used to help explain how the control measure is used, but they are not a part of the control measure.
<p>Nuclear Contaminated Area</p> <p>Symbol Set Code: 25 Code: 271900</p>			
<p>Radiological Contaminated Area</p> <p>Symbol Set Code: 25 Code: 272000</p>			
<p>Radiological Contaminated Area – Toxic Industrial Material</p> <p>Symbol Set Code: 25 Code: 272001</p>			

TABLE H-XXI. CBRN defense control measure symbols - Continued.

CONTROL MEASURE	TEMPLATE	DRAW RULES	EXAMPLE Note: The symbols that have been colored grey are used to help explain how the control measure is used, but they are not a part of the control measure.
<p>Minimum Safe Distance Zone</p> <p>Symbol Set Code: 25 Code: 272100</p> <p>Static/ Dynamic: D</p>	 <p>The template diagram shows a central point labeled 'CENTER POINT' with an arrow pointing to it. Three concentric circles are drawn around this center point, labeled '1', '2', and '3' from innermost to outermost. Three anchor points are also shown: 'PT 1' is on the left side of the outermost circle, 'PT 2' is at the top of the outermost circle, and 'PT 3' is on the right side of the outermost circle. Arrows point from each label to its corresponding element in the diagram.</p>	<p><u>Anchor Points.</u> This symbol requires four anchor points. The center point defines the center of the symbol. Points 1, 2 and 3 define the radii of circles 1, 2 and 3.</p> <p><u>Size/Shape.</u> As defined by the operator.</p> <p><u>Orientation.</u> The center point is typically centered over the known/suspected source location of an NBC event.</p> <p>Note: This symbol is used in fielded and deployed systems for collateral damage assessments/pre dictions for indirect fire and air to ground engagements.</p>	 <p>The example diagram shows three concentric circles. The innermost circle is labeled '1', the middle circle is labeled '2', and the outermost circle is labeled '3'. The circles are drawn with solid black lines.</p>

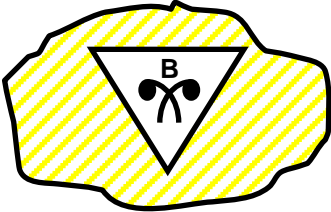
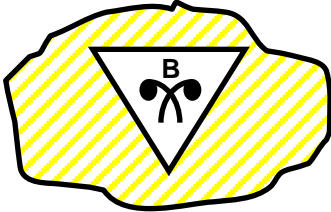
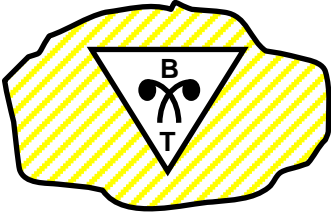
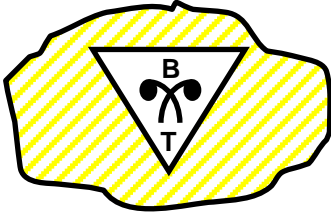
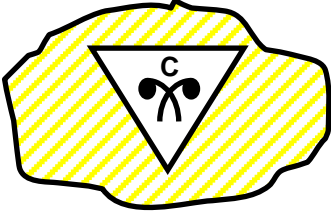
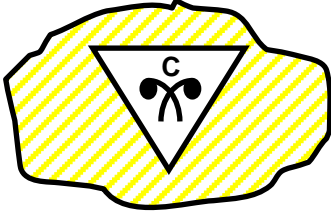
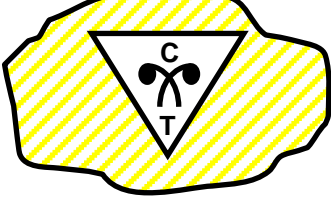
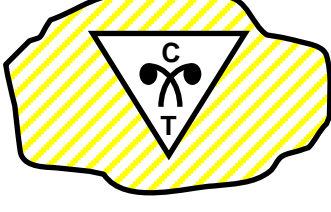
TABLE H-XXI. CBRN defense control measure symbols - Continued.

CONTROL MEASURE	TEMPLATE	DRAW RULES	EXAMPLE Note: The symbols that have been colored grey are used to help explain how the control measure is used, but they are not a part of the control measure.
<p>Radiation Dose Rate Contour Line</p> <p>A line on a map, diagram or overlay joining all points at which the radiation dose rate at a given time is the same.</p> <p>Symbol Set Code: 25 Code: 272200</p> <p>Static/ Dynamic: D</p>		<p><u>Anchor Points:</u> This symbol requires at least three anchor points to define the boundary of the area. Add as many points as necessary to accurately reflect the area's size and shape.</p> <p><u>Size/Shape:</u> Determined by the anchor points. The information fields should be moveable and scalable as a block within the area.</p> <p><u>Orientation:</u> Not applicable.</p>	
<p>Chemical Event</p> <p>Symbol Set Code: 25 Code: 281300</p>		<p><u>Anchor Points.</u> This symbol requires one anchor point. The anchor point defines the midpoint of the symbol's base.</p> <p><u>Size/Shape.</u> Static.</p> <p><u>Orientation.</u> The</p>	

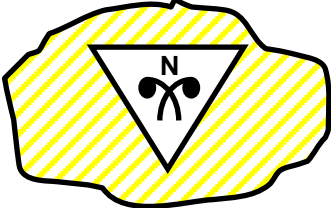
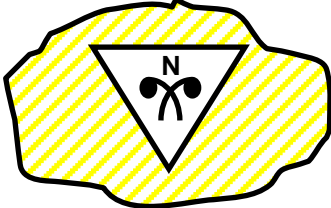
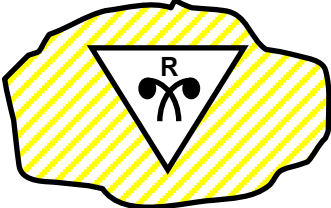
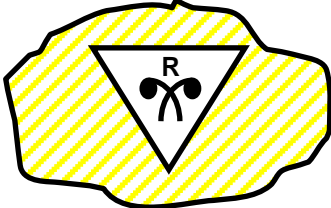
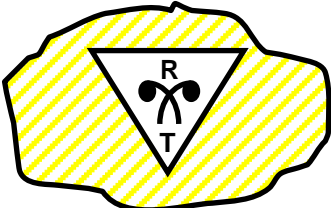
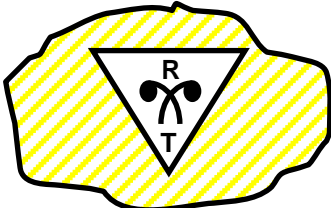
TABLE H-XXI. CBRN defense control measure symbols - Continued.

CONTROL MEASURE	TEMPLATE	DRAW RULES	EXAMPLE Note: The symbols that have been colored grey are used to help explain how the control measure is used, but they are not a part of the control measure.
<p>Chemical – Toxic Industrial Material</p> <p>Symbol Set Code: 25 Code: 281301</p>		<p>symbol will typically be oriented upright.</p> <p>Note: This symbol can be rotated in 90 degree increments.</p> <p>Static/ Dynamic: S</p>	<p>300700ZJAN06 </p>
<p>Biological Event</p> <p>Symbol Set Code: 25 Code: 281400</p>			<p>211400ZNOV07 </p>
<p>Biological – Toxic Industrial Material</p> <p>Symbol Set Code: 25 Code: 281401</p>			<p>211400ZNOV07 </p>

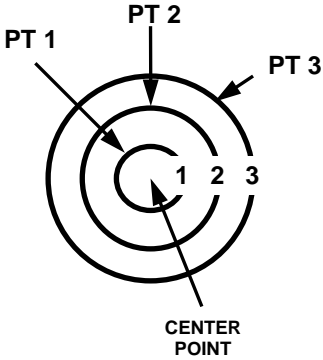
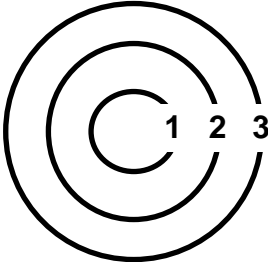
TABLE H-XXI. CBRN defense control measure symbols - Continued.

CONTROL MEASURE	TEMPLATE	DRAW RULES	EXAMPLE Note: The symbols that have been colored grey are used to help explain how the control measure is used, but they are not a part of the control measure.
<p>Nuclear Event</p> <p>Symbol Set Code: 25 Code: 281500</p>			<p>092100ZFEB07 1 3.5KT XRAY SOURCE IED ENY SL12071962</p> 
<p>Nuclear Fallout Producing Event</p> <p>Symbol Set Code: 25 Code: 281600</p>			<p>291000ZFEB08 1 1MT B61 ENY BOMB JK01041973</p> 
<p>Radiological Event</p> <p>Symbol Set Code: 25 Code: 281700</p>			<p>092100ZMAR08 1 H IED ENY ME11201970</p> 

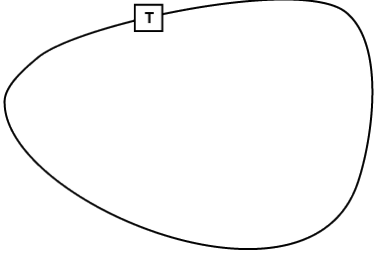
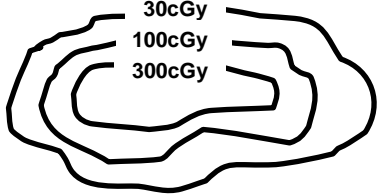
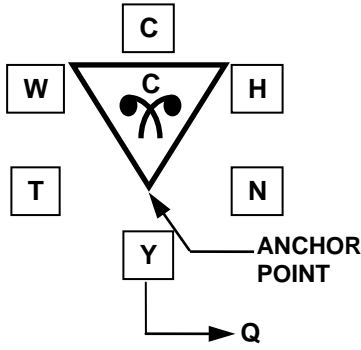
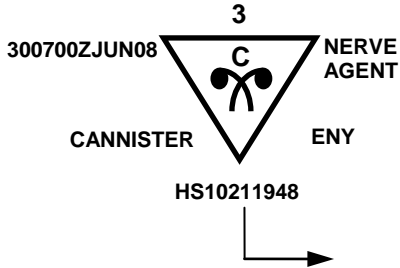
TABLE H-XXI. CBRN defense control measure symbols - Continued.

CONTROL MEASURE	TEMPLATE	DRAW RULES	EXAMPLE Note: The symbols that have been colored grey are used to help explain how the control measure is used, but they are not a part of the control measure.
<p>Radiological – Toxic Industrial Material</p> <p>Symbol Set Code: 25 Code: 281701</p>			
<i>Decontamination Points/Sites</i>			
<p>General Decontamination Point/Site</p> <p>Symbol Set Code: 25 Code: 281800</p>		<p><u>Anchor Points.</u> This symbol requires one anchor point. The point defines the tip of the inverted cone.</p> <p><u>Size/Shape.</u> Static.</p> <p><u>Orientation.</u> The symbol will typically be oriented upright.</p>	
<p>Alternate Decontamination Point/Site</p> <p>Symbol Set Code: 25 Code: 281801</p>		<p>Static/ Dynamic: S</p>	

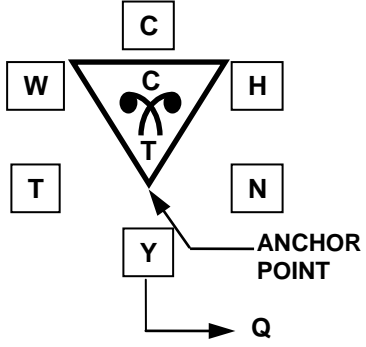
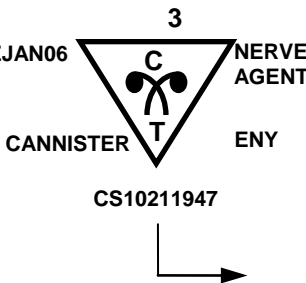
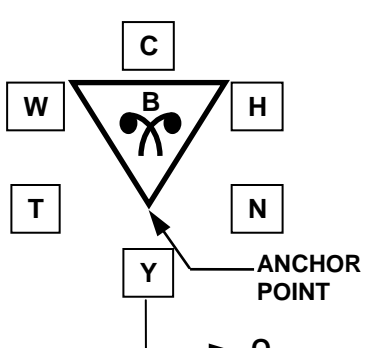
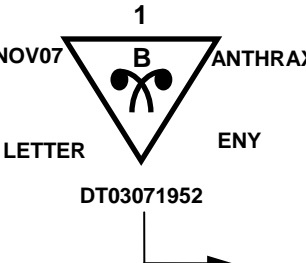
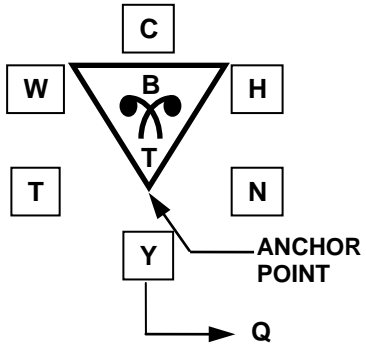
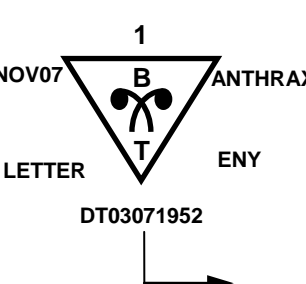
TABLE H-XXI. CBRN defense control measure symbols - Continued.

CONTROL MEASURE	TEMPLATE	DRAW RULES	EXAMPLE Note: The symbols that have been colored grey are used to help explain how the control measure is used, but they are not a part of the control measure.
<p>Equipment Decontamination Point/Site</p> <p>Symbol Set Code: 25 Code: 281802</p>			<p>WHEELED</p> <p>030200ZMAY08 - 050700ZMAY08</p> 
<p>Troop Decontamination Point/Site</p> <p>Symbol Set Code: 25 Code: 281803</p>			<p>3</p> <p>030200ZSEP08 - 050700ZSEP08</p> 
<p>Equipment / Troop Decontamination Point/Site</p> <p>Symbol Set Code: 25 Code: 281804</p>			<p>CONTRACTOR OPERATED</p> <p>210700ZAPR08 - 071800ZMAY08</p> 

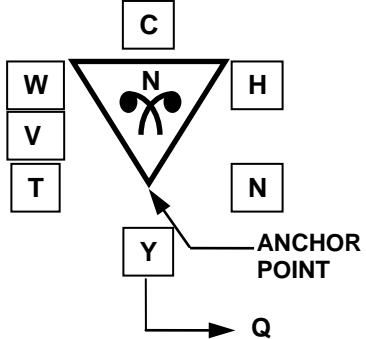
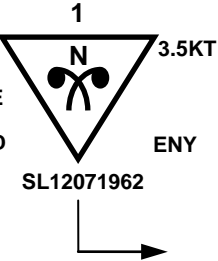
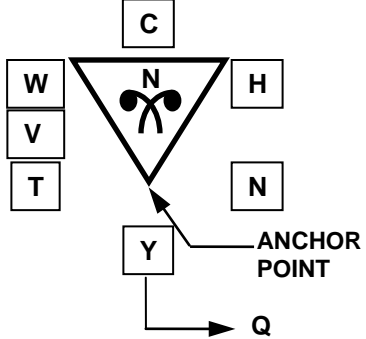
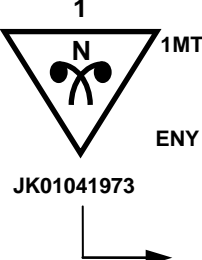
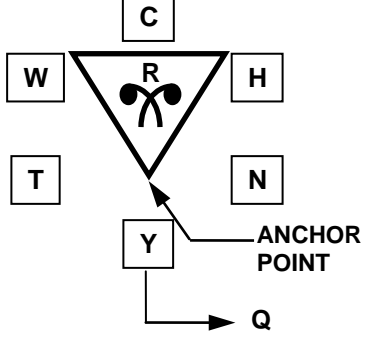
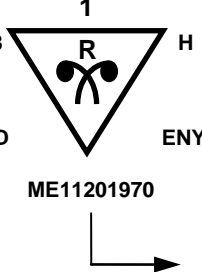
TABLE H-XXI. CBRN defense control measure symbols - Continued.

CONTROL MEASURE	TEMPLATE	DRAW RULES	EXAMPLE Note: The symbols that have been colored grey are used to help explain how the control measure is used, but they are not a part of the control measure.
<p>Operational De-contamination Point/Site</p> <p>Symbol Set Code: 25 Code: 281805</p>			<p>6</p> <p>030200ZMAY08 - 050700ZMAY08</p> 
<p>Thorough De-contamination Point/Site</p> <p>Symbol Set Code: 25 Code: 281806</p>			<p>MEDICAL</p> <p>030200ZMAY08 - 050700ZMAY08</p> 
<p>Main Equipment De-contamination Point/Site</p> <p>Symbol Set Code: 25 Code: 281807</p>			<p>8</p> <p>030200ZMAY08 - 050700ZMAY08</p> 

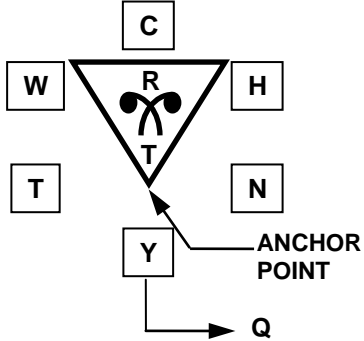
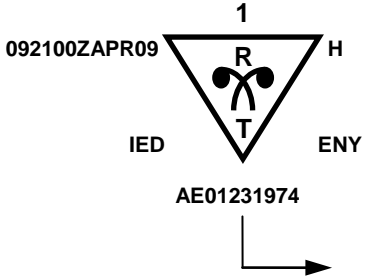
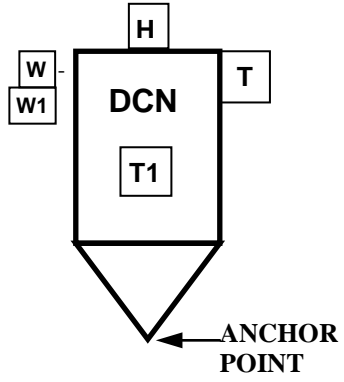
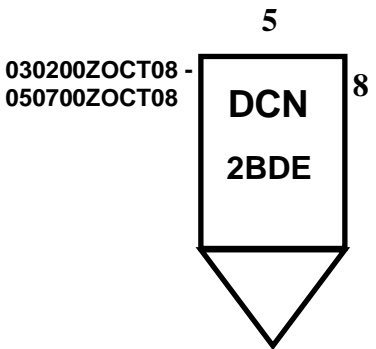
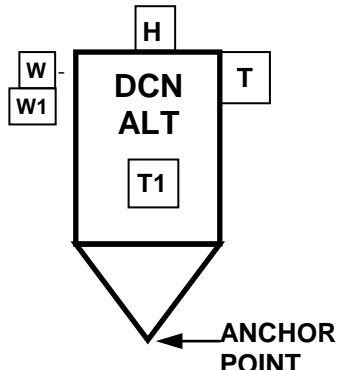
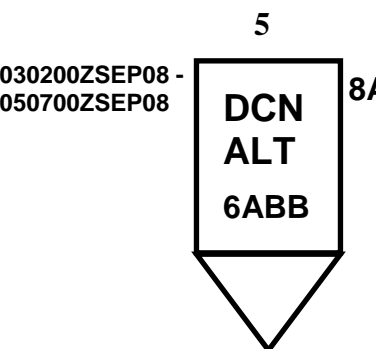
TABLE H-XXI. CBRN defense control measure symbols - Continued.

CONTROL MEASURE	TEMPLATE	DRAW RULES	EXAMPLE Note: The symbols that have been colored grey are used to help explain how the control measure is used, but they are not a part of the control measure.
<p>Forward Troop Decontamination Point/Site</p> <p>Symbol Set Code: 25 Code: 281808</p>			<p>030200ZMAY08 - 050700ZMAY08</p> 
<p>Wounded Personnel Decontamination Site</p> <p>Symbol Set Code: 25 Code: 281809</p>			<p>030200ZMAY08 - 050700ZMAY08</p> 

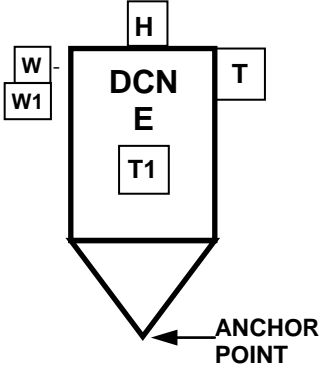
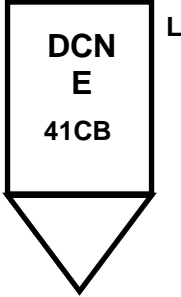
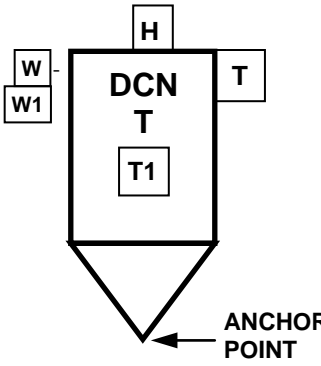
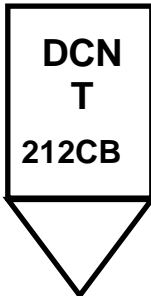
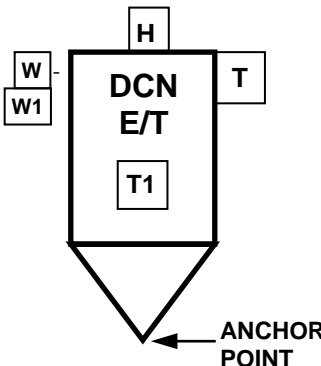
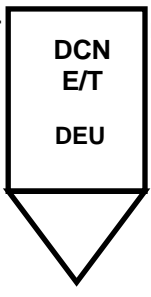
H.5.24 Sustainment control measures.

H.5.24.1 Sustainment control measures. The provision of logistics and personnel services required to maintain and prolong operations until successful mission accomplishment.

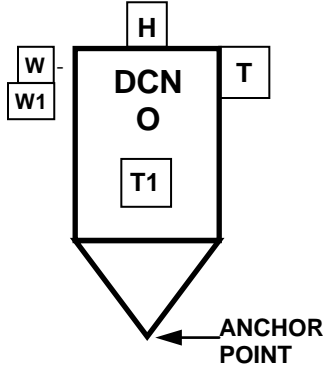
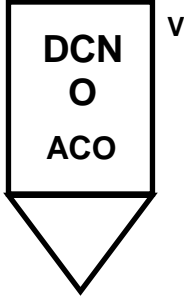
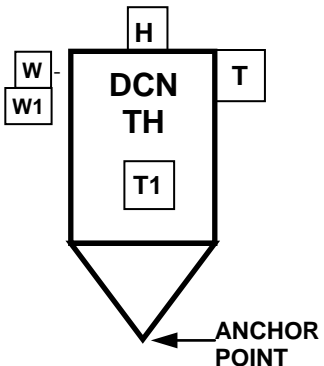
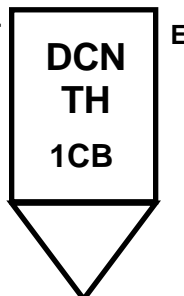
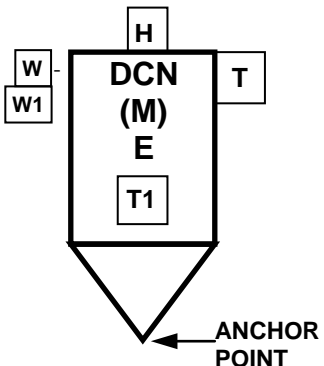
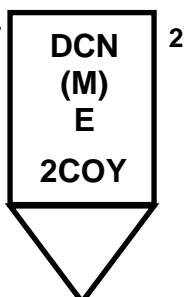
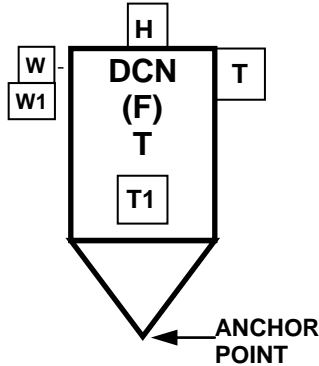
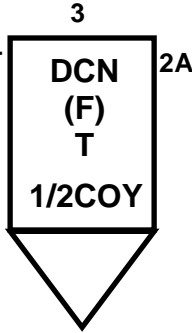
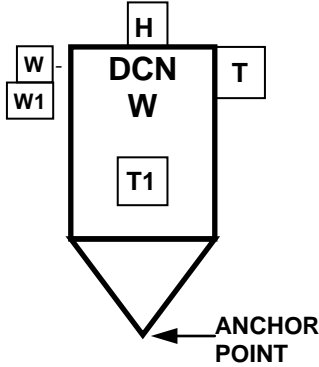
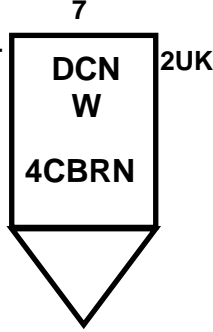
TABLE H-XXII. Sustainment point control measure symbols.

CONTROL MEASURE	TEMPLATE	DRAW RULES	EXAMPLE Note: The symbols that have been colored grey are used to help explain how the control measure is used, but they are not a part of the control measure.
<p>Sustainment Points</p> <p>Symbol Set Code: 25 Code: 320000</p>	<p>N/A</p>		<p>N/A</p>

TABLE H-XXII. Sustainment point control measure symbols - Continued.



CONTROL MEASURE	TEMPLATE	DRAW RULES	EXAMPLE Note: The symbols that have been colored grey are used to help explain how the control measure is used, but they are not a part of the control measure.
<p>Ambulance Exchange Point</p> <p>A location where a patient is transferred from one ambulance to another en route to a medical treatment facility. This may be an established point in an ambulance shuttle system or it may be designated independently.</p> <p>Symbol Set Code: 25 Code: 320100</p>		<p><u>Anchor Points.</u> This symbol requires one anchor point. The point defines the tip of the inverted cone.</p> <p><u>Size/Shape.</u> Static.</p> <p><u>Orientation.</u> The symbol will typically be oriented upright.</p> <p>Static/ Dynamic: S</p>	<p>030200ZMAY08 - 050700ZMAY08</p> <p>3</p> <p>1</p> 
<p>Ammunition Supply Point</p> <p>An area designated to receive, store, reconfigure and issue Class V material.</p> <p>Symbol Set Code: 25 Code: 320200</p>			<p>AVIATION</p> <p>030200ZMAY08 - 050700ZMAY08</p> <p>RC(W)</p> 

TABLE H-XXII. Sustainment point control measure symbols - Continued.

CONTROL MEASURE	TEMPLATE	DRAW RULES	EXAMPLE Note: The symbols that have been colored grey are used to help explain how the control measure is used, but they are not a part of the control measure.
<p>Ammunition Transfer Point</p> <p>A designated temporary site from which Class V material is transferred to unit vehicles.</p> <p>Symbol Set Code: 25 Code: 320300</p>			<p>SMALL ARMS</p> <p>030200ZMAY08 - 050700ZMAY08</p> 
<p>Cannibalization Point</p> <p>Symbol Set Code: 25 Code: 320400</p>			<p>9</p> <p>030200ZMAY08 - 050700ZMAY08</p> 
<p>Casualty Collection Point</p> <p>A specific location where casualties are assembled to be transported to a medical treatment facility, for example, a company aid post.</p> <p>Symbol Set Code: 25 Code: 320500</p>			<p>5</p> <p>030200ZMAY08 - 050700ZMAY08</p> 

TABLE H-XXII. Sustainment point control measure symbols - Continued.

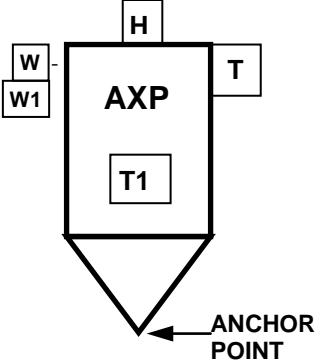

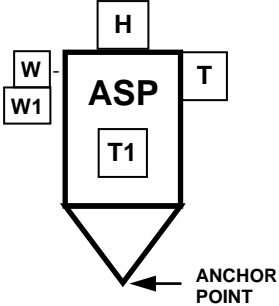
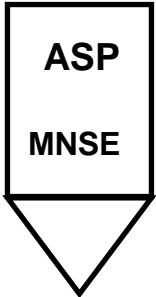
CONTROL MEASURE	TEMPLATE	DRAW RULES	EXAMPLE Note: The symbols that have been colored grey are used to help explain how the control measure is used, but they are not a part of the control measure.
<p>Civilian Collection Point</p> <p>A specific location where civilians are assembled to be transported to another location.</p> <p>Symbol Set Code: 25 Code: 320600</p>			<p>030200ZMAY08 - 050700ZMAY08</p> 
<p>Detainee Collection Point</p> <p>A specific location where detainee are assembled to be transported to another location.</p> <p>Symbol Set Code: 25 Code: 320700</p>			<p>120700ZMAR08 - 211800ZMAR08</p> 
<p>Enemy Prisoner of War (EPW) Collection Point</p> <p>A specific location where enemy prisoners of war are assembled to be transported to another location.</p> <p>Symbol Set Code: 25 Code: 320800</p>			<p>030200ZMAY08 - 050700ZMAY08</p> 

TABLE H-XXII. Sustainment point control measure symbols - Continued.

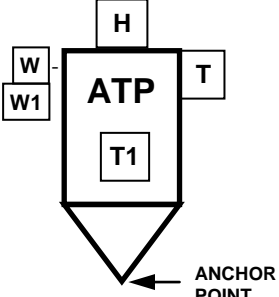
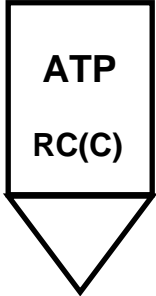
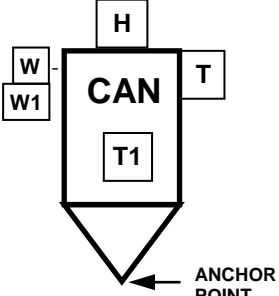
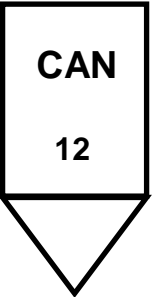
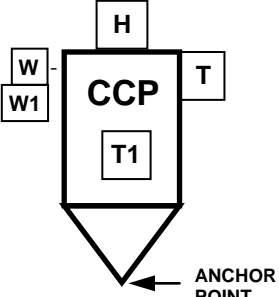
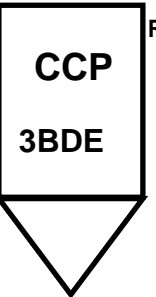
CONTROL MEASURE	TEMPLATE	DRAW RULES	EXAMPLE Note: The symbols that have been colored grey are used to help explain how the control measure is used, but they are not a part of the control measure.
<p>Logistics Release Point (LRP)</p> <p>Symbol Set Code: 25 Code: 320900</p>	 <p>The diagram shows a downward-pointing arrowhead shape. At the top is a box labeled 'H'. Below it is a larger box labeled 'LRP'. To the left of the 'LRP' box are two smaller boxes labeled 'W' and 'W1'. To the right is a box labeled 'T'. Below the 'LRP' box is a box labeled 'T1'. At the bottom point of the arrowhead, an arrow points to the text 'ANCHOR POINT'.</p>		<p>030200ZMAY08 - 050700ZMAY08</p>  <p>The example diagram shows a downward-pointing arrowhead shape. At the top is the number '5'. Below it is a box labeled 'LRP'. To the right of the 'LRP' box is the number '10'. Below the 'LRP' box is the text '2ID'. At the bottom point of the arrowhead, there is a grey shaded area.</p>
<p>Maintenance Collection Point (MCP)</p> <p>A point established to collect equipment awaiting repair, controlled exchange, cannibalization, or evacuation. It may be operated by the user or by the direct support maintenance units.</p> <p>Symbol Set Code: 25 Code: 321000</p>	 <p>The diagram shows a downward-pointing arrowhead shape. At the top is a box labeled 'H'. Below it is a larger box labeled 'MCP'. To the left of the 'MCP' box are two smaller boxes labeled 'W' and 'W1'. To the right is a box labeled 'T'. Below the 'MCP' box is a box labeled 'T1'. At the bottom point of the arrowhead, an arrow points to the text 'ANCHOR POINT'.</p>		<p>030200ZMAY08 - 050700ZMAY08</p>  <p>The example diagram shows a downward-pointing arrowhead shape. At the top is the number '1'. Below it is a box labeled 'MCP'. To the right of the 'MCP' box is the letter 'N'. Below the 'MCP' box is the text 'RC(E)'. At the bottom point of the arrowhead, there is a grey shaded area.</p>
<p>Medical Evacuation (MEDEVAC) Pick-up Point</p> <p>Symbol Set Code: 25 Code: 321100</p>	 <p>The diagram shows a downward-pointing arrowhead shape. At the top is a box labeled 'H'. Below it is a larger box labeled 'MEP'. To the left of the 'MEP' box are two smaller boxes labeled 'W' and 'W1'. To the right is a box labeled 'T'. Below the 'MEP' box is a box containing a cross symbol, and below that is a box labeled 'T1'. At the bottom point of the arrowhead, an arrow points to the text 'ANCHOR POINT'.</p>		<p>030200ZMAY08 - 050700ZMAY08</p>  <p>The example diagram shows a downward-pointing arrowhead shape. At the top is the number '2'. Below it is a box labeled 'MEP'. To the right of the 'MEP' box is the text 'US'. Below the 'MEP' box is a box containing a cross symbol, and below that is the number '3'. At the bottom point of the arrowhead, there is a grey shaded area.</p>

TABLE H-XXII. Sustainment point control measure symbols - Continued.

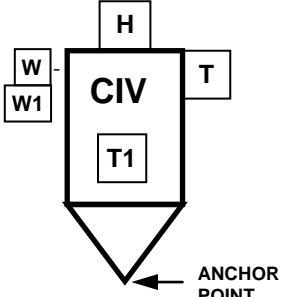
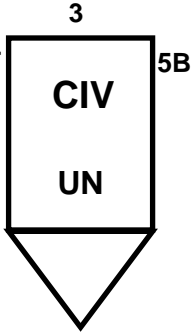
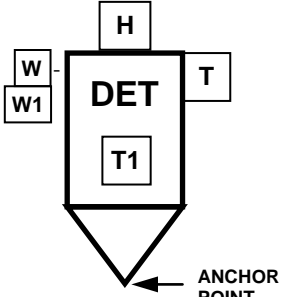
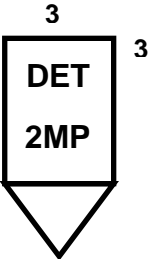
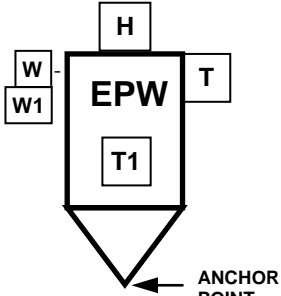
CONTROL MEASURE	TEMPLATE	DRAW RULES	EXAMPLE Note: The symbols that have been colored grey are used to help explain how the control measure is used, but they are not a part of the control measure.
<p>Rearm, Refuel and Resupply Point (R3P)</p> <p>A designated point through which a unit passes where it receives fuel, ammunition and other necessary supplies to continue operations.</p> <p>Symbol Set Code: 25 Code: 321200</p>			
<p>Refuel On the Move (ROM) Point</p> <p>An area established to ensure that fuel tanks on combat and fuel servicing vehicles are full before they arrive in the unit's tactical assembly area.</p> <p>Symbol Set Code: 25 Code: 321300</p>			

TABLE H-XXII. Sustainment point control measure symbols - Continued.

CONTROL MEASURE	TEMPLATE	DRAW RULES	EXAMPLE Note: The symbols that have been colored grey are used to help explain how the control measure is used, but they are not a part of the control measure.
<p>Traffic Control Post (TCP)</p> <p>Manned post used to preclude interruption of traffic flow or movement along designated routes.</p> <p>Symbol Set Code: 25 Code: 321400</p>			
<p>Trailer Transfer Point (TTP)</p> <p>A location where trailers are transferred from one carrier to another while en route.</p> <p>Symbol Set Code: 25 Code: 321500</p>			

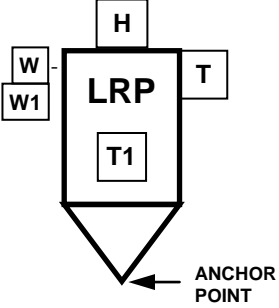
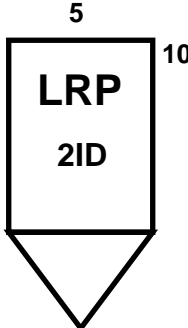
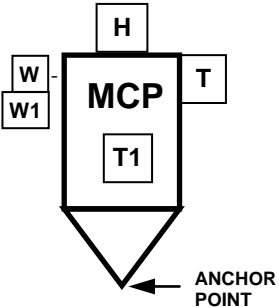
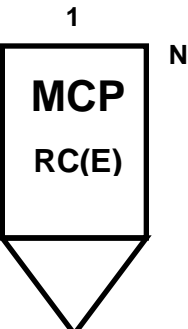
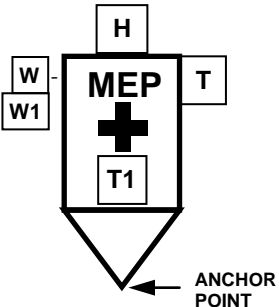
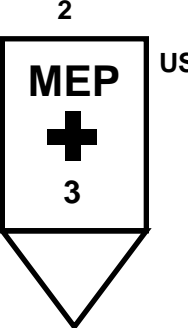
TABLE H-XXII. Sustainment point control measure symbols - Continued.

CONTROL MEASURE	TEMPLATE	DRAW RULES	EXAMPLE Note: The symbols that have been colored grey are used to help explain how the control measure is used, but they are not a part of the control measure.
<p>Unit Maintenance Collection Point (UMCP)</p> <p>A location or series of locations, operated by a battalion maintenance platoon, that is the nearest point to the combat unit to which equipment can be recovered and where limited parts are available and some repairs can be performed.</p> <p>Symbol Set Code: 25 Code: 321600</p>			

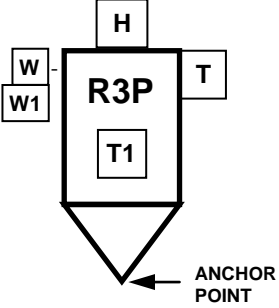
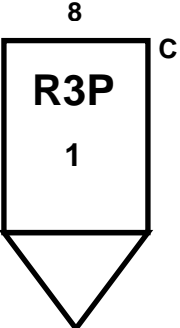
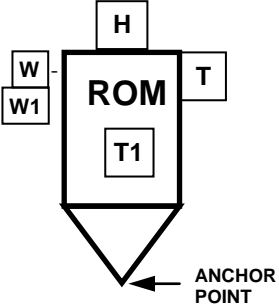
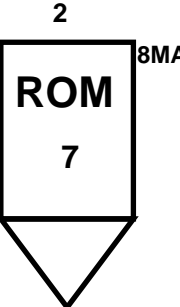
H.5.25 Supply points.

H.5.25.1 Supply point. Any point where supplies are issued in detail. Supply points follow the format as shown above with a modification to the symbol. As with the symbol for supply units, there is an additional line placed toward the bottom of the box. In building points, the name/type of the point is abbreviated and positioned inside the top part of the point symbol in field “A”. For some supply symbols this may be a symbol icon. [STANAG 2961](#) provides comparison charts for NATO and NATO nation classes of supply.

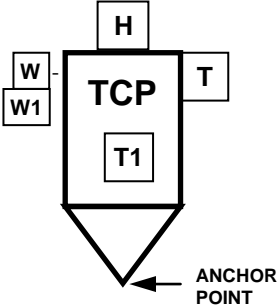
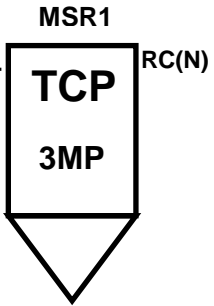
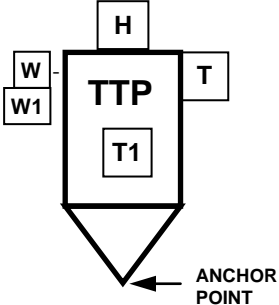
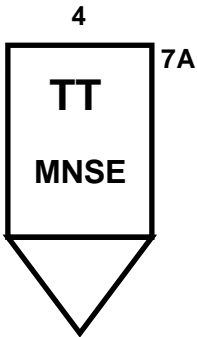
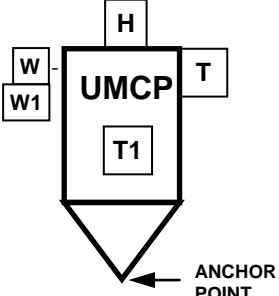
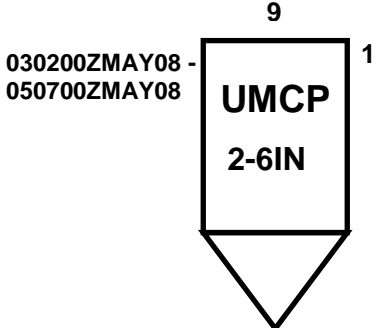
TABLE H-XXIII. Supply point control measure symbols.

CONTROL MEASURE	TEMPLATE	DRAW RULES	EXAMPLE Note: The symbols that have been colored grey are used to help explain how the control measure is used, but they are not a part of the control measure.
<p>General Supply Point</p> <p>Symbol Set Code: 25 Code: 321700</p>		<p><u>Anchor Points.</u> This symbol requires one anchor point. The point defines the tip of the inverted cone.</p> <p><u>Size/Shape.</u> Static.</p> <p><u>Orientation.</u> The symbol will typically be oriented upright.</p>	<p>030200ZMAY08 - 050700ZMAY08</p> 
<p>NATO Class I</p> <p>Those items which are consumed by personnel or animals at the approximately uniform rate, irrespective of local changes in combat or terrain conditions. (STANAG 2961)</p> <p>Symbol Set Code: 25 Code: 321701</p>		<p>Static/ Dynamic: S</p>	<p>030200ZMAY08 - 050700ZMAY08</p> 

TABLE H-XXIII. Supply point control measure symbols - Continued.

CONTROL MEASURE	TEMPLATE	DRAW RULES	EXAMPLE Note: The symbols that have been colored grey are used to help explain how the control measure is used, but they are not a part of the control measure.
<p>NATO Class II</p> <p>Supplies for which allowances are established by tables of organization and equipment. (STANAG 2961)</p> <p>Symbol Set Code: 25 Code: 321702</p>			<p>030200ZMAY08 - 050700ZMAY08</p> 
<p>NATO Class III</p> <p>Fuels and lubricants for all purposes, except for operating aircraft or for use in weapons such as flame throwers. (STANAG 2961)</p> <p>Symbol Set Code: 25 Code: 321703</p>			<p>030200ZMAY08 - 050700ZMAY08</p> 
<p>NATO Class IV</p> <p>Supplies for which initial issue allowances are not prescribed by approved issue tables. (STANAG 2961)</p> <p>Symbol Set Code: 25 Code: 321704</p>			<p>030200ZMAY08 - 050700ZMAY08</p> 

TABLE H-XXIII. Supply point control measure symbols - Continued.

CONTROL MEASURE	TEMPLATE	DRAW RULES	EXAMPLE Note: The symbols that have been colored grey are used to help explain how the control measure is used, but they are not a part of the control measure.
<p>NATO Class V</p> <p>Ammunition, explosives and chemical agents of all types. (STANAG 2961)</p> <p>Symbol Set Code: 25 Code: 321705</p>			<p>>20MM</p> <p>030200ZMAY08 - 6A 050700ZMAY08</p> 
<p>NATO Multiple Supply Class Point.</p> <p>Note: Use supply class numbers (I, II, III, IV and V) for A field or ALL for all classes of supply.</p> <p>Symbol Set Code: 25 Code: 321706</p>			<p>6 14</p> <p>030200ZAPR08 - 050700ZAPR08</p> 
<p>US Class I</p> <p>Symbol Set Code: 25 Code: 321707</p>			<p>6 14</p> <p>030200ZAPR08 - 050700ZAPR08</p> 

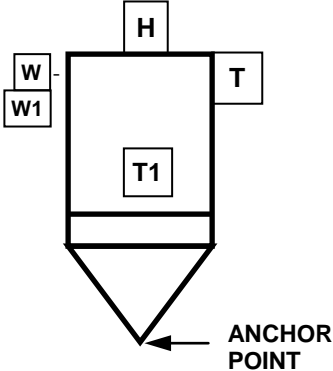
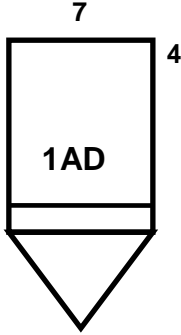
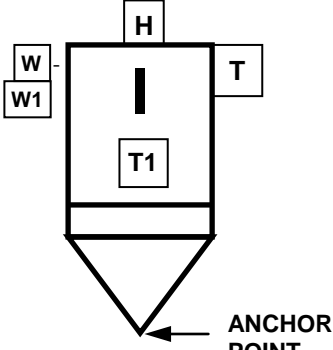
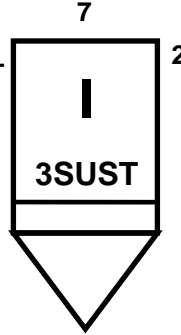
TABLE H-XXIII. Supply point control measure symbols - Continued.

CONTROL MEASURE	TEMPLATE	DRAW RULES	EXAMPLE Note: The symbols that have been colored grey are used to help explain how the control measure is used, but they are not a part of the control measure.
<p>US Class II</p> <p>Symbol Set Code: 25 Code: 321708</p>			
<p>US Class III</p> <p>Symbol Set Code: 25 Code: 321709</p>			
<p>US Class IV</p> <p>Symbol Set Code: 25 Code: 321710</p>			

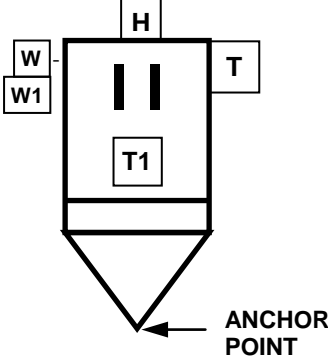
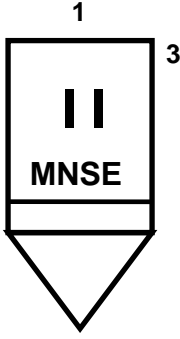
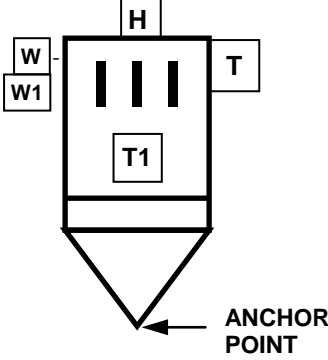
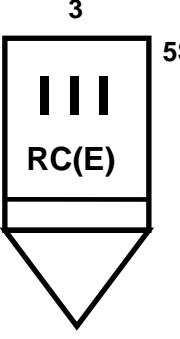
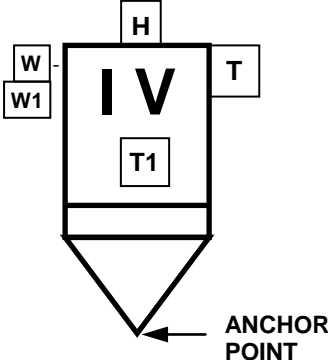
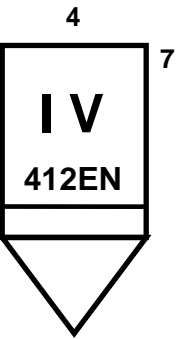
TABLE H-XXIII. Supply point control measure symbols - Continued.

CONTROL MEASURE	TEMPLATE	DRAW RULES	EXAMPLE Note: The symbols that have been colored grey are used to help explain how the control measure is used, but they are not a part of the control measure.
<p>US Class V</p> <p>Symbol Set Code: 25 Code: 321711</p>			<p>030200ZAPR08 - 050700ZAPR08</p> 
<p>US Class VI</p> <p>Symbol Set Code: 25 Code: 321712</p>			<p>030200ZAPR08 - 050700ZAPR08</p> 
<p>US Class VII</p> <p>Symbol Set Code: 25 Code: 321713</p>			<p>030200ZAPR08 - 050700ZAPR08</p> 

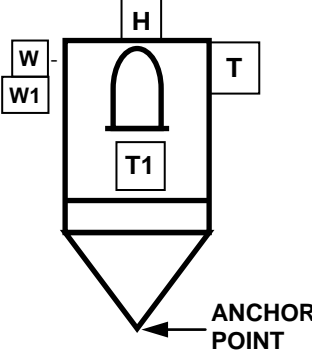
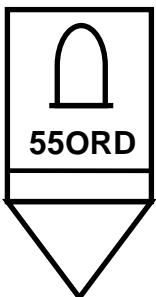
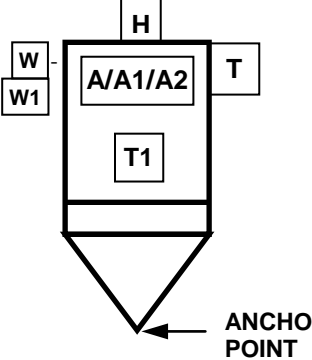
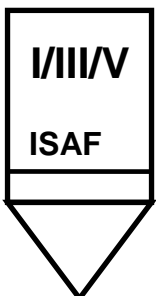
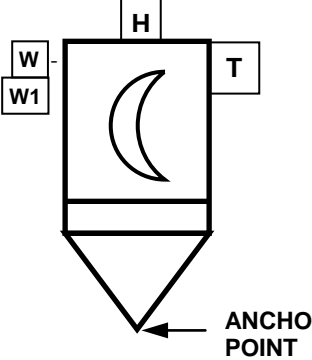
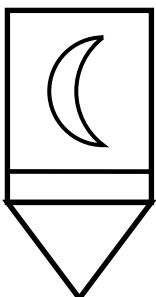
TABLE H-XXIII. Supply point control measure symbols - Continued.

CONTROL MEASURE	TEMPLATE	DRAW RULES	EXAMPLE Note: The symbols that have been colored grey are used to help explain how the control measure is used, but they are not a part of the control measure.
<p>US Class VIII</p> <p>Symbol Set Code: 25 Code: 321714</p>			
<p>US Class IX</p> <p>Symbol Set Code: 25 Code: 321715</p>			
<p>US Class X</p> <p>Symbol Set Code: 25 Code: 321716</p>			

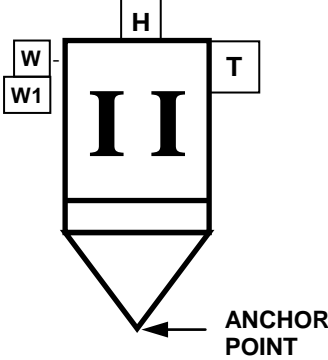
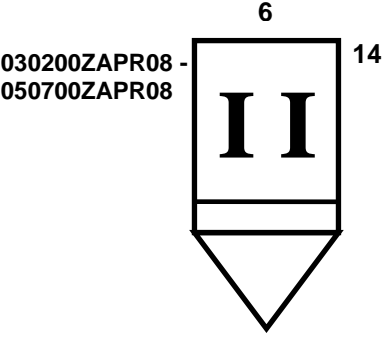
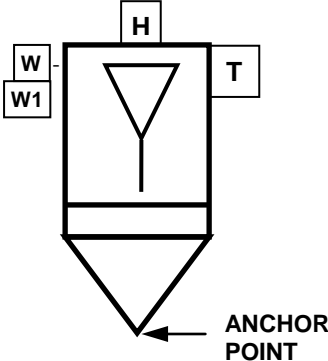
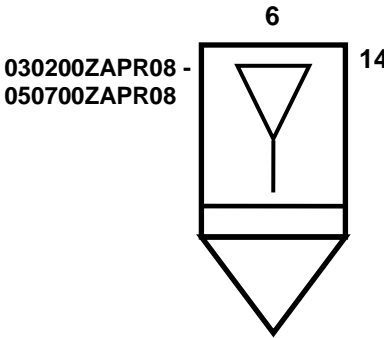
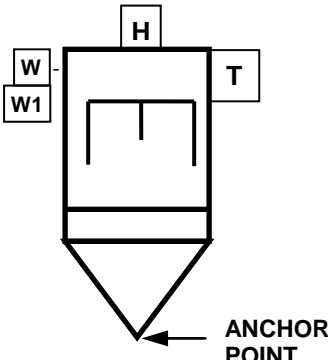
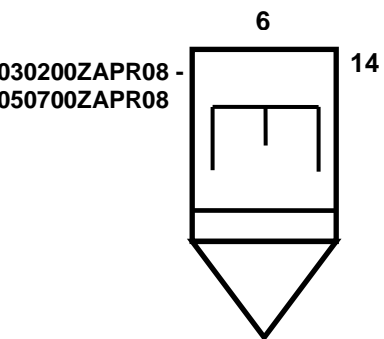
TABLE H-XXIII. Supply point control measure symbols - Continued.



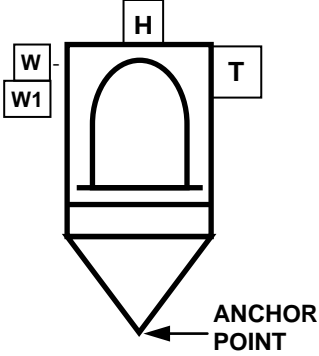
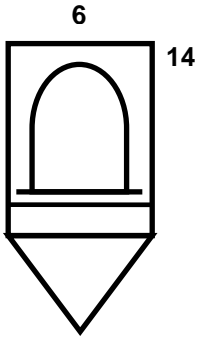
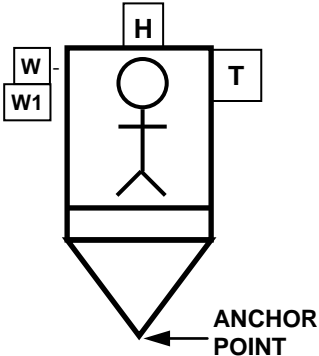
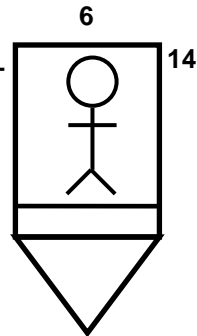
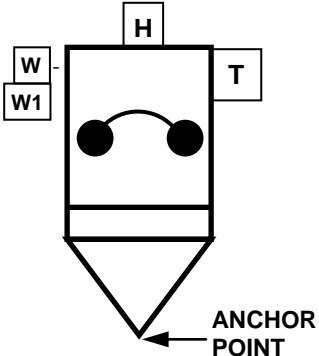
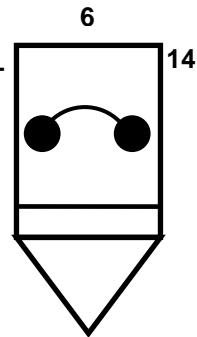

CONTROL MEASURE	TEMPLATE	DRAW RULES	EXAMPLE Note: The symbols that have been colored grey are used to help explain how the control measure is used, but they are not a part of the control measure.
Medical Supply Point Symbol Set Code: 25 Code: 321800			
Convoy A group of vehicles organized for the purpose of control and orderly movement with or without escort protection.			
Sustainment Areas Symbol Set Code: 25 Code: 310000	N/A		N/A
Detainee Holding Area Symbol Set Code: 25 Code: 310100		<u>Anchor Points.</u> This symbol requires at least three anchor points to define the boundary of the area. Add as many points as necessary to accurately reflect the area's size and shape.	
Enemy Prisoner of War Holding Area Symbol Set Code: 25 Code: 310200		accurately reflect the area's size and shape. <u>Size/Shape.</u>	

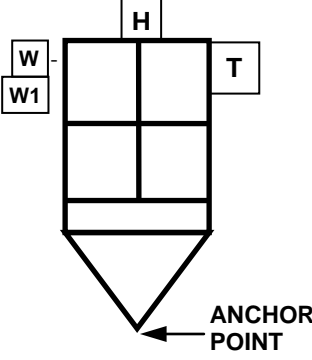
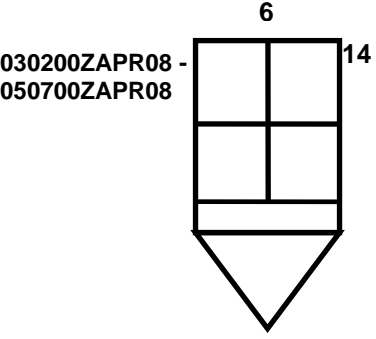
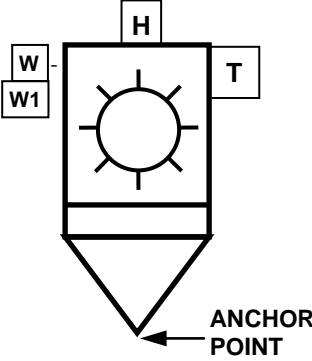
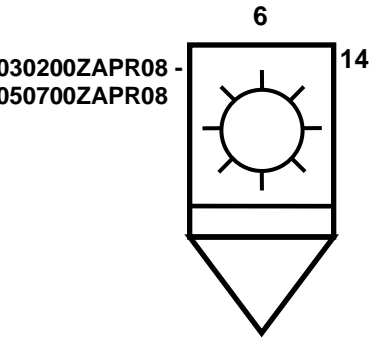
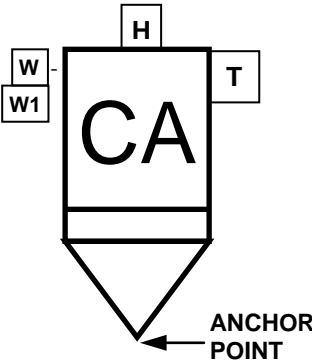
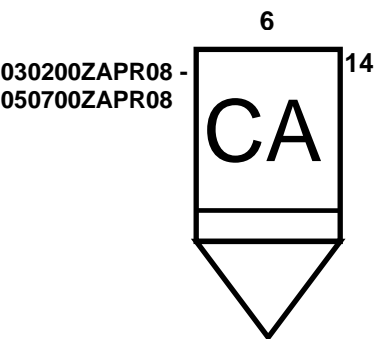
TABLE H-XXIII. Supply point control measure symbols - Continued.



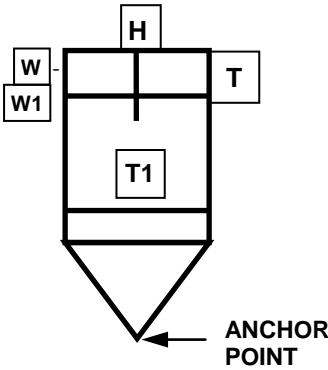
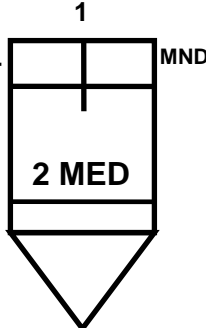
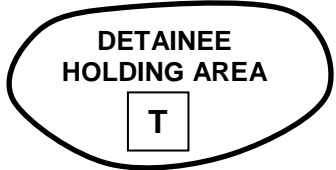

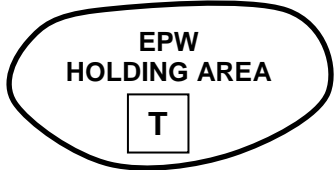
CONTROL MEASURE	TEMPLATE	DRAW RULES	EXAMPLE Note: The symbols that have been colored grey are used to help explain how the control measure is used, but they are not a part of the control measure.
<p>Forward Arming and Refueling Point (FARP)</p> <p>A temporary facility — organized, equipped and deployed by an aviation commander and normally located in the main battle area closer to the area where operations are being conducted than the aviation unit’s combat service area — to provide fuel and ammunition necessary for the employment of aviation maneuver units in combat. The forward arming and refueling point permits combat aircraft to rapidly refuel and rearm simultaneously.</p> <p>Symbol Set Code: 25 Code: 310300</p>		<p>Determined by the anchor points. <u>Orientation.</u> Not applicable.</p> <p>Static/ Dynamic: D</p>	
<p>Refugee Holding Area</p> <p>Symbol Set Code: 25 Code: 310400</p>			

TABLE H-XXIII. Supply point control measure symbols - Continued.

CONTROL MEASURE	TEMPLATE	DRAW RULES	EXAMPLE Note: The symbols that have been colored grey are used to help explain how the control measure is used, but they are not a part of the control measure.
<i>Support Area</i>			
<p>Regimental Support Area</p> <p>Symbol Set Code: 25 Code: 310500</p>		<p><u>Anchor Points.</u> This symbol requires at least three anchor points to define the boundary of the area. Add as many points as necessary to accurately reflect the area's size and shape.</p> <p><u>Size/Shape.</u> Determined by the anchor points.</p> <p><u>Orientation.</u> Not applicable.</p> <p>Static/ Dynamic: D</p>	
<p>Brigade Support Area (BSA)</p> <p>A designated area in which combat service support elements from division support command and corps support command provide logistic support to a brigade.</p> <p>Symbol Set Code: 25 Code: 310600</p>		<p><u>Anchor Points.</u> This symbol requires at least three anchor points to define the boundary of the area. Add as many points as necessary to accurately reflect the area's size and shape.</p> <p><u>Size/Shape.</u> Determined by the anchor points.</p> <p><u>Orientation.</u> Not applicable.</p> <p>Static/ Dynamic: D</p>	
<p>Division Support Area</p> <p>An area normally located in the division rear and often positioned near air-landing facilities along the main supply route.</p> <p>Symbol Set Code: 25 Code: 310700</p>		<p><u>Anchor Points.</u> This symbol requires at least three anchor points to define the boundary of the area. Add as many points as necessary to accurately reflect the area's size and shape.</p> <p><u>Size/Shape.</u> Determined by the anchor points.</p> <p><u>Orientation.</u> Not applicable.</p> <p>Static/ Dynamic: D</p>	

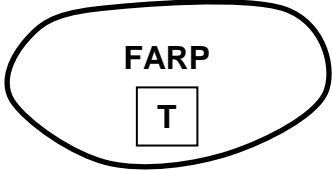
TABLE H-XXIII. Supply point control measure symbols - Continued.

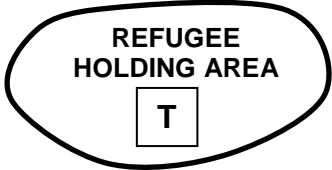
CONTROL MEASURE	TEMPLATE	DRAW RULES	EXAMPLE Note: The symbols that have been colored grey are used to help explain how the control measure is used, but they are not a part of the control measure.
<p>Sustainment Lines</p> <p>Symbol Set Code: 25 Code: 330000</p>	<p>N/A</p>		<p>N/A</p>
<p>Moving Convoy</p> <p>Symbol Set Code: 25 Code: 330100</p> <p>Static/ Dynamic: D</p>	 <p>PT 2 PT 1</p> <p>Note: The arrow points in the direction the convoy is moving.</p>	<p><u>Anchor Points.</u> This symbol requires two anchor points. Point 1 defines the tip of the arrowhead and point 2 defines the rear of the symbol.</p> <p><u>Size/Shape.</u> Points 1 and 2 determine the length of the symbol, which varies only in length.</p> <p><u>Orientation.</u> Not applicable.</p>	 <p>060500ZJUN07 - 060800ZJUN07</p>

TABLE H-XXIII. Supply point control measure symbols - Continued.

CONTROL MEASURE	TEMPLATE	DRAW RULES	EXAMPLE Note: The symbols that have been colored grey are used to help explain how the control measure is used, but they are not a part of the control measure.
<p>Halted Convoy</p> <p>Symbol Set Code: 25 Code: 330200</p> <p>Static/ Dynamic: D</p>		<p><u>Anchor Points.</u> This symbol requires at least two anchor points to define the line. Additional points can be defined to extend and shape the line.</p> <p><u>Size/Shape.</u> The first and last anchor points determine the length of the line. The line segment between each pair of anchor points will repeat all information associated with the line segment.</p> <p><u>Orientation.</u> Orientation is determined by the anchor points.</p>	 <p>251400ZJUN07 - 061600ZJUN07</p>

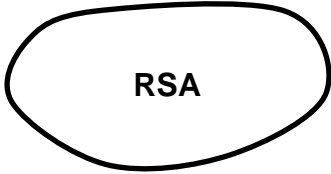
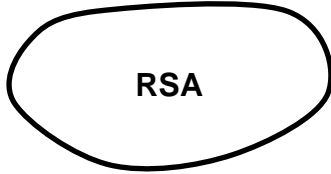
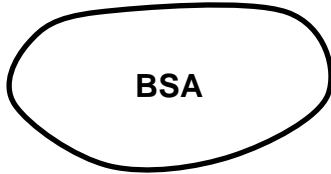
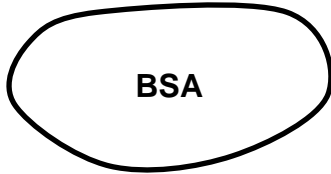
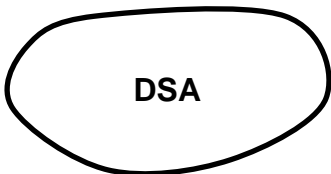
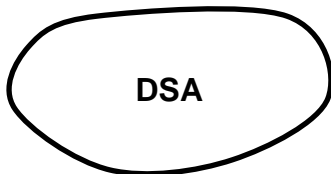
TABLE H-XXIII. Supply point control measure symbols - Continued.



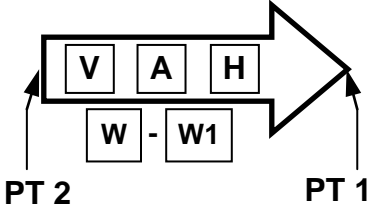
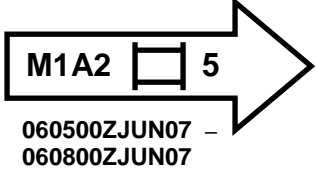



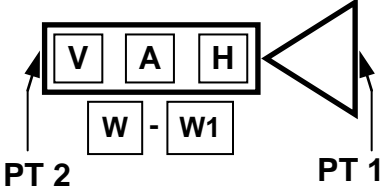
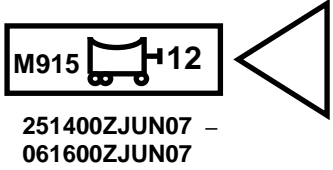



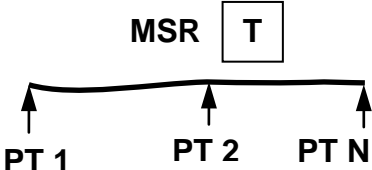

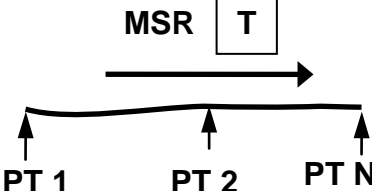
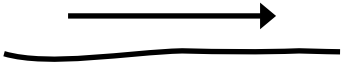
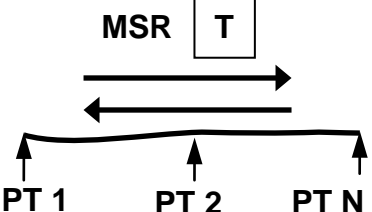
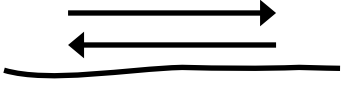
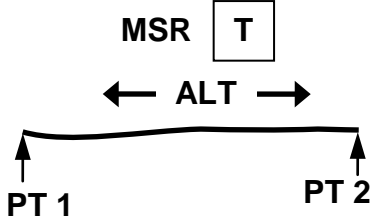
CONTROL MEASURE	TEMPLATE	DRAW RULES	EXAMPLE Note: The symbols that have been colored grey are used to help explain how the control measure is used, but they are not a part of the control measure.
<i>Supply Route</i>			
<p>Main Supply Route (MSR)</p> <p>The route or routes designated within an area of operations upon which the bulk of traffic flows in support of military operations.</p> <p>Symbol Set Code: 25 Code: 330300</p>		<p><u>Anchor Points.</u> This symbol requires at least two anchor points to define the line. Additional points can be defined to extend and shape the line. <u>Size/Shape.</u> The first and last anchor points determine the length of the line. The line segment between each pair of anchor points will repeat all information associated with the line segment. <u>Orientation.</u> Orientation is determined by the anchor points. Supply routes normally follow established roads. Therefore, anchor points normally follow the shape of the road.</p>	<p>MSR CAMEL</p> 
<p>One Way Traffic</p> <p>Symbol Set Code: 25 Code: 330301</p>		<p>segment.</p>	<p>MSR 3</p> 
<p>Two Way Traffic</p> <p>Symbol Set Code: 25 Code: 330302</p>		<p>segment. Orientation is determined by the anchor points. Supply routes normally follow established roads. Therefore, anchor points normally follow the shape of the road.</p>	<p>MSR SUMMER</p> 
<p>Alternating Traffic</p> <p>Symbol Set Code: 25 Code: 330303</p>		<p>Static/ Dynamic: D</p>	<p>MSR 1</p> 

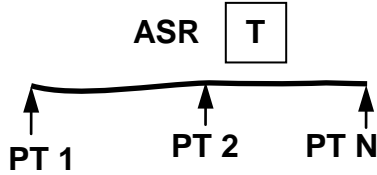
TABLE H-XXIII. Supply point control measure symbols - Continued.

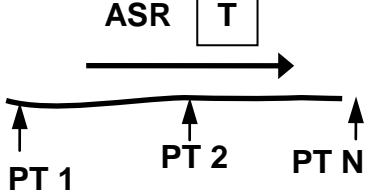
CONTROL MEASURE	TEMPLATE	DRAW RULES	EXAMPLE Note: The symbols that have been colored grey are used to help explain how the control measure is used, but they are not a part of the control measure.
<p>Alternate Supply Route (ASR)</p> <p>A route or routes designated within an area of operations to provide for the movement of traffic when main supply routes become disabled or congested.</p> <p>Symbol Set Code: 25 Code: 330400</p>	 <p>The diagram shows a wavy line representing a route. Above it, the text 'ASR' is followed by a box containing the letter 'T'. Three vertical arrows labeled 'PT 1', 'PT 2', and 'PT N' point upwards to the wavy line.</p>		<p>ASR DONKEY</p>  <p>A simple wavy line representing the ASR control measure.</p>
<p>One Way Traffic</p> <p>Symbol Set Code: 25 Code: 330401</p>	 <p>The diagram shows a wavy line with a straight arrow pointing to the right above it. Above the arrow is the text 'ASR' followed by a box containing 'T'. Three vertical arrows labeled 'PT 1', 'PT 2', and 'PT N' point upwards to the wavy line.</p>		<p>MSR 3</p>  <p>A wavy line with a straight arrow pointing to the right above it, representing MSR 3.</p>
<p>Two Way Traffic</p> <p>Symbol Set Code: 25 Code: 330402</p>	 <p>The diagram shows a wavy line with two straight arrows above it: one pointing right and one pointing left. Above the right-pointing arrow is the text 'ASR' followed by a box containing 'T'. Three vertical arrows labeled 'PT 1', 'PT 2', and 'PT N' point upwards to the wavy line.</p>		<p>MSR SUMMER</p>  <p>A wavy line with two straight arrows above it, one pointing right and one pointing left, representing MSR SUMMER.</p>
<p>Alternating Traffic</p> <p>Symbol Set Code: 25 Code: 330403</p>	 <p>The diagram shows a wavy line with a straight double-headed arrow above it. Above the double-headed arrow is the text 'ASR' followed by a box containing 'T'. Two vertical arrows labeled 'PT 1' and 'PT 2' point upwards to the wavy line.</p>		<p>MSR 1</p>  <p>A wavy line with a straight double-headed arrow above it, representing MSR 1.</p>

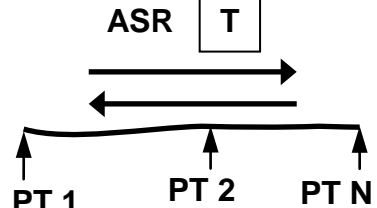
H.5.26 Mission Tasks.

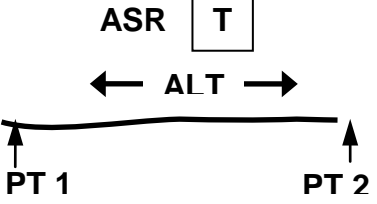
H.5.26.1 Mission Task Symbols. A specific activity performed by a unit while executing a form of tactical operation or form of maneuver.

TABLE H-XXIV. Mission Task Symbols.



CONTROL MEASURE	TEMPLATE	DRAW RULES	EXAMPLE Note: The symbols that have been colored grey are used to help explain how the control measure is used, but they are not a part of the control measure.
<p>Mission Tasks</p> <p>Symbol Set Code: 25 Code: 340000</p> <p>Static/Dynamic: N/A</p>	<p>N/A</p>		<p>N/A</p>
<p>Block</p> <p>Symbol Set Code: 25 Code: 340100</p> <p>Static/Dynamic: D</p>		<p><u>Anchor Points.</u> This graphic requires three anchor points. Points 1 and 2 define the endpoints of the graphic's vertical line. Point 3 defines the endpoint of the graphic's horizontal line. <u>Size/Shape.</u> Points 1 and 2 determine the length of the vertical line. Points 2 and 3 determine the length of the horizontal line, which will project perpendicularly from the midpoint of the vertical line. <u>Orientation.</u> The head of the "T" typically faces enemy forces.</p>	

TABLE H-XXIV. Mission Task Symbols - Continued.

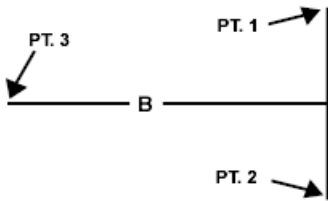

CONTROL MEASURE	TEMPLATE	DRAW RULES	EXAMPLE Note: The symbols that have been colored grey are used to help explain how the control measure is used, but they are not a part of the control measure.
<p>Breach</p> <p>Symbol Set Code: 25 Code: 340200</p> <p>Static/Dynamic: D</p>		<p><u>Anchor Points.</u> This symbol requires three anchor points. Points 1 and 2 define the endpoints of the symbol's opening and point 3 defines the rear of the symbol.</p> <p><u>Size/Shape.</u> Points 1 and 2 determine the symbol's height and point 3 determines its length. The vertical line at the rear of the symbol will be the same height as the opening and parallel to it.</p> <p><u>Orientation.</u> The opening defines the span of the breach and typically faces enemy forces.</p>	
<p>Bypass</p> <p>Symbol Set Code: 25 Code: 340300</p> <p>Static/Dynamic: D</p>		<p><u>Anchor Points.</u> This symbol requires three anchor points. Points 1 and 2 define the tips of the arrowheads and point 3 defines the rear of the symbol.</p> <p><u>Size/Shape.</u> Points 1 and 2 determine the</p>	

TABLE H-XXIV. Mission Task Symbols - Continued.

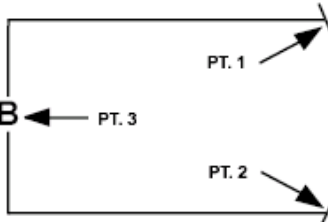

CONTROL MEASURE	TEMPLATE	DRAW RULES	EXAMPLE Note: The symbols that have been colored grey are used to help explain how the control measure is used, but they are not a part of the control measure.
<p>Canalize</p> <p>Symbol Set Code: 25 Code: 340400</p> <p>Static/Dynamic: D</p>		<p>symbol's height and point 3 determines its length. The vertical line at the rear of the symbol will be the same height as the opening and parallel to it. <u>Orientation.</u> The opening typically faces enemy forces.</p>	

TABLE H-XXIV. Mission Task Symbols - Continued.

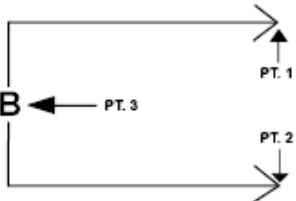
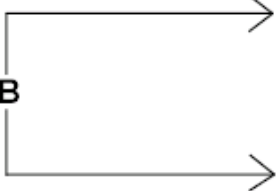
CONTROL MEASURE	TEMPLATE	DRAW RULES	EXAMPLE Note: The symbols that have been colored grey are used to help explain how the control measure is used, but they are not a part of the control measure.
<p>Clear</p> <p>Symbol Set Code: 25 Code: 340500</p> <p>Static/Dynamic: D</p>		<p><u>Anchor Points.</u> This symbol requires three anchor points. Points 1 and 2 define the endpoints of the symbol's vertical line and point 3 defines the rear of the symbol.</p> <p><u>Size/Shape.</u> Points 1 and 2 determine the symbol's height and point 3 determines its length. The spacing between the symbol's arrows will stay proportional to the symbol's height. The tip of the middle arrowhead will be at the midpoint of the vertical line. The arrows will stay perpendicular to the vertical line, regardless of the rotational orientation of the symbol as a whole.</p> <p><u>Orientation.</u> The arrows typically point toward enemy forces.</p>	

TABLE H-XXIV. Mission Task Symbols - Continued.

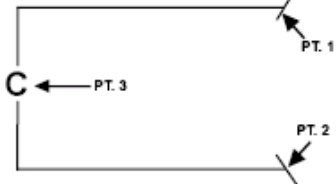

CONTROL MEASURE	TEMPLATE	DRAW RULES	EXAMPLE Note: The symbols that have been colored grey are used to help explain how the control measure is used, but they are not a part of the control measure.
<p>Counterattack</p> <p>Symbol Set Code: 25 Code: 340600</p> <p>Static/Dynamic: D</p> <p>Note: The dashed lines in this graphic shall be displayed in present and anticipated status.</p>		<p><u>Anchor Points.</u> The symbol requires N anchor points, where N is between 3 and 50. Point 1 defines the tip of the arrowhead. Point N-1 defines the rear of the symbol. Point N defines the back of the arrowhead. Anchor points are numbered sequentially beginning with point number one (1), in increments of one (1).</p>	
<p>Counterattack by Fire</p> <p>Symbol Set Code: 25 Code: 340700</p> <p>Static/Dynamic: D</p> <p>Note: The dashed lines in this graphic shall be displayed in present and anticipated status.</p>		<p><u>Size/Shape.</u> Points 1 through N-1 determine the symbol's centerline and Point N determines the width.</p> <p><u>Orientation.</u> The arrowhead typically points toward enemy forces.</p>	

TABLE H-XXIV. Mission Task Symbols - Continued.

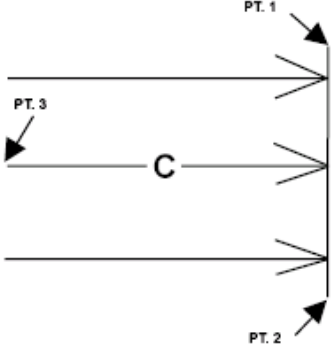
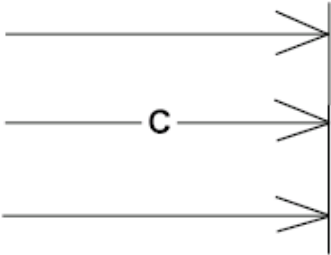
CONTROL MEASURE	TEMPLATE	DRAW RULES	EXAMPLE Note: The symbols that have been colored grey are used to help explain how the control measure is used, but they are not a part of the control measure.
<p>Delay</p> <p>Symbol Set Code: 25 Code: 340800</p> <p>Static/Dynamic: D</p>	 <p>The template diagram shows a horizontal line with an arrowhead pointing left. A 180-degree circular arc is attached to the right end of the line. Three anchor points are marked: PT. 1 at the tip of the arrowhead, PT. 2 at the right end of the line, and PT. 3 at the top of the arc. A diameter 'D' is indicated between PT. 1 and PT. 2, and a width 'W' is indicated for the arc.</p>	<p><u>Anchor Points.</u> This symbol requires three anchor points. Point 1 defines the tip of the arrowhead. Point 2 defines the end of the straight line portion of the symbol. Point 3 defines the diameter and orientation of the 180 degree circular arc.</p> <p><u>Size/Shape.</u> Points 1 and 2 determine the length of the straight line portion of the symbol. Point 3 defines which side of the line the arc is on and the diameter of the arc.</p> <p><u>Orientation.</u> The arrow points in the direction of the action. The tip of the arrowhead may indicate the location where the action is to conclude. The unit's current location is typically represented at the base of the arc. The 180 degree circular arc is always perpendicular to the line.</p>	 <p>The example diagram shows the final symbol: a horizontal line with an arrowhead pointing left and a 180-degree circular arc attached to the right end. A diameter 'D' is shown between the arrowhead and the arc.</p>

TABLE H-XXIV. Mission Task Symbols - Continued.

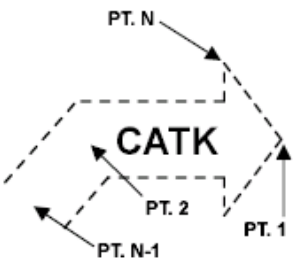
CONTROL MEASURE	TEMPLATE	DRAW RULES	EXAMPLE Note: The symbols that have been colored grey are used to help explain how the control measure is used, but they are not a part of the control measure.
<p>Destroy</p> <p>Symbol Set Code: 25 Code: 340900</p> <p>Static/Dynamic: S</p>		<p><u>Anchor Points.</u> This symbol requires one anchor point. The center point defines center of the symbol.</p> <p><u>Size/Shape.</u> Static.</p> <p><u>Orientation.</u> The symbol is typically centered over the desired location.</p>	

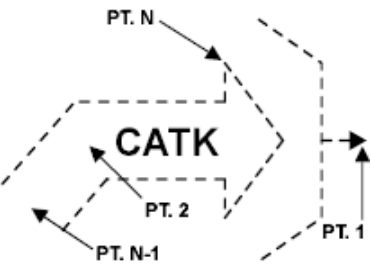
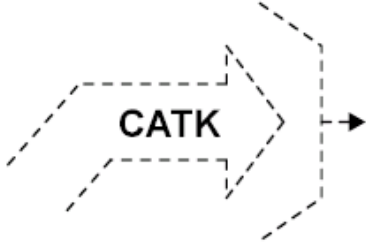
TABLE H-XXIV. Mission Task Symbols - Continued.

CONTROL MEASURE	TEMPLATE	DRAW RULES	EXAMPLE Note: The symbols that have been colored grey are used to help explain how the control measure is used, but they are not a part of the control measure.
<p>Disrupt</p> <p>Symbol Set Code: 25 Code: 341000</p> <p>Static/Dynamic: D</p>		<p><u>Anchor Points.</u> This graphic requires three anchor points. Points 1 and 2 define the end points of the graphic's vertical line. Point 3 defines the tip of the longest arrow.</p> <p><u>Size/Shape.</u> Points 1 and 2 determine the height of the graphic and point 3 determines its length. The spacing between the graphic's arrows will stay proportional to the graphic's vertical line. The length of the short arrows will remain in proportion to the length of the longest arrow. The arrows are perpendicular to the baseline (vertical line) and parallel to each other.</p> <p><u>Orientation.</u> The arrows typically point toward enemy forces.</p>	

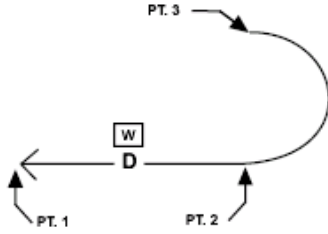
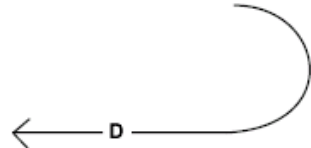
TABLE H-XXIV. Mission Task Symbols - Continued.

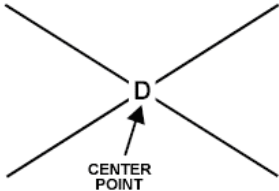
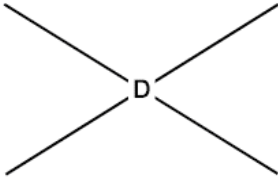

CONTROL MEASURE	TEMPLATE	DRAW RULES	EXAMPLE Note: The symbols that have been colored grey are used to help explain how the control measure is used, but they are not a part of the control measure.
<p>Fix</p> <p>Symbol Set Code: 25 Code: 341100</p> <p>Static/Dynamic: D</p>		<p><u>Anchor Points.</u> This graphic requires 2 anchor points. Point 1 defines the tip of the arrowhead, and point 2 defines the rear of the graphic.</p> <p><u>Size/Shape.</u> Points 1 and 2 determine the length of the graphic, which varies only in length.</p> <p><u>Orientation.</u> The arrow typically points toward enemy forces with the tip of the arrowhead indicating the location of the action.</p>	
<p>Follow and Assume</p> <p>Symbol Set Code: 25 Code: 341200</p> <p>Static/Dynamic: D</p> <p>Note: The dashed lines in this graphic shall be displayed in present and anticipated status.</p>		<p><u>Anchor Points.</u> This symbol requires exactly two anchor points. Point 1 defines the tip of the arrowhead and point 2 defines the rear of the symbol.</p> <p><u>Size/Shape.</u> Points 1 and 2 determine the length of the symbol, which varies only in</p>	

TABLE H-XXIV. Mission Task Symbols - Continued.

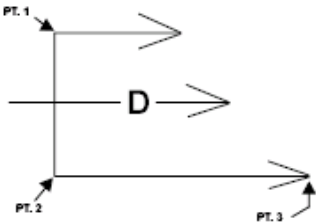
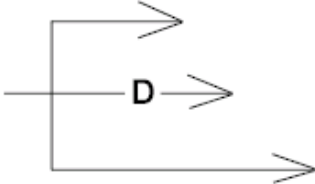

CONTROL MEASURE	TEMPLATE	DRAW RULES	EXAMPLE Note: The symbols that have been colored grey are used to help explain how the control measure is used, but they are not a part of the control measure.
<p>Follow and Support</p> <p>Symbol Set Code: 25 Code: 341300</p> <p>Static/Dynamic: D</p>		<p>length. <u>Orientation.</u> The arrow typically points in the direction of the action.</p>	
<p>Interdict</p> <p>Symbol Set Code: 25 Code: 341400</p> <p>Static/Dynamic: S</p>		<p><u>Anchor Points.</u> This symbol requires one anchor point. The center point defines the center of the symbol. <u>Size/Shape.</u> There should be 45 degrees of angular separation between the two arrows. <u>Orientation.</u> The symbol is typically centered over the desired location.</p>	

TABLE H-XXIV. Mission Task Symbols - Continued.

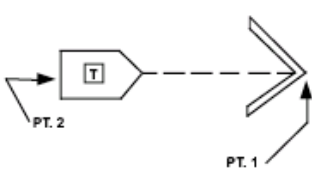
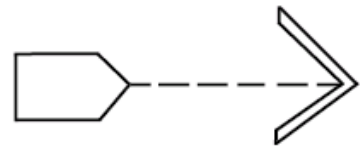
CONTROL MEASURE	TEMPLATE	DRAW RULES	EXAMPLE Note: The symbols that have been colored grey are used to help explain how the control measure is used, but they are not a part of the control measure.
<p>Isolate</p> <p>Symbol Set Code: 25 Code: 341500</p> <p>Static/Dynamic: D</p>		<p><u>Anchor Points.</u> This symbol requires two anchor points. Point 1 defines the center point of the symbol and point 2 defines the symbol's start point and radius. <u>Size/Shape.</u> The radius will be long enough for the symbol to encompass the UEI(s) or feature(s) being isolated. The opening will be a 30 degree arc of the circle. <u>Orientation.</u> The opening will be on the friendly side of the symbol.</p>	
<p>Neutralize</p> <p>Symbol Set Code: 25 Code: 341600</p> <p>Static/Dynamic: S</p> <p>Note: The dashed lines in this graphic shall be displayed in present and anticipated status.</p>		<p><u>Anchor Points.</u> This symbol requires one anchor point. The center point defines the center of the symbol. <u>Size/Shape.</u> Static. <u>Orientation.</u> The symbol is typically centered over the desired location.</p>	

TABLE H-XXIV. Mission Task Symbols - Continued.

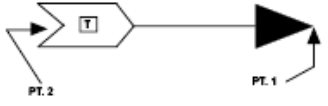
CONTROL MEASURE	TEMPLATE	DRAW RULES	EXAMPLE Note: The symbols that have been colored grey are used to help explain how the control measure is used, but they are not a part of the control measure.
<p>Occupy</p> <p>Symbol Set Code: 25 Code: 341700</p> <p>Static/Dynamic: D</p>		<p><u>Anchor Points.</u> This symbol requires two anchor points. Point 1 defines the center point of the symbol and point 2 defines the symbol's start point and radius.</p> <p><u>Size/Shape.</u> Points 1 and 2 will determine a radius that is long enough for the symbol to encompass the feature(s) being occupied. The opening will be a 30-degree arc of the circle.</p> <p><u>Orientation.</u> The opening will be on the friendly side of the control measure</p>	

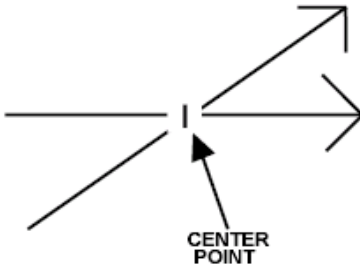
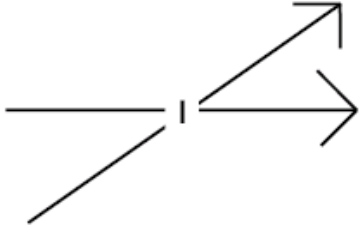
TABLE H-XXIV. Mission Task Symbols - Continued.

CONTROL MEASURE	TEMPLATE	DRAW RULES	EXAMPLE Note: The symbols that have been colored grey are used to help explain how the control measure is used, but they are not a part of the control measure.
<p>Penetrate</p> <p>Symbol Set Code: 25 Code: 341800</p> <p>Static/Dynamic: D</p>	 <p>The template diagram shows a horizontal line with an arrowhead pointing to a vertical line. Three anchor points are indicated: PT. 1 at the top of the vertical line, PT. 2 at the bottom of the vertical line, and PT. 3 at the left end of the horizontal line. A letter 'P' is placed at the junction of the horizontal and vertical lines.</p>	<p><u>Anchor Points.</u> This symbol requires three anchor points. Points 1 and 2 define the endpoints of the symbol's vertical line. Point 3 defines the rear of the symbol.</p> <p><u>Size/Shape.</u> Points 1 and 2 determine the height of the symbol and point 3 determines its length. The arrow will project perpendicularly from the midpoint of the vertical line.</p> <p><u>Orientation.</u> The arrow points toward enemy forces.</p>	 <p>The example diagram shows a horizontal line with an arrowhead pointing to a vertical line. A letter 'P' is placed at the junction of the horizontal and vertical lines.</p>

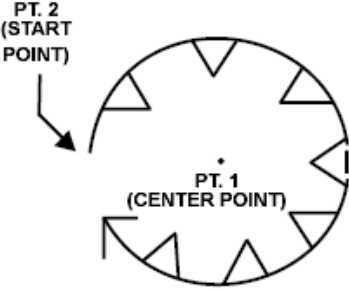
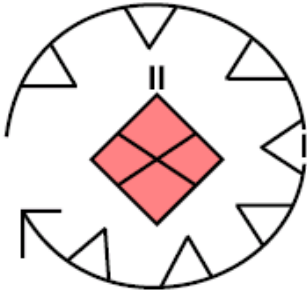
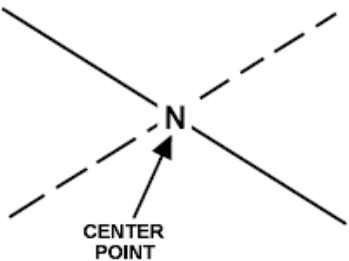
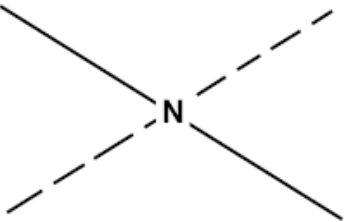
TABLE H-XXIV. Mission Task Symbols - Continued.

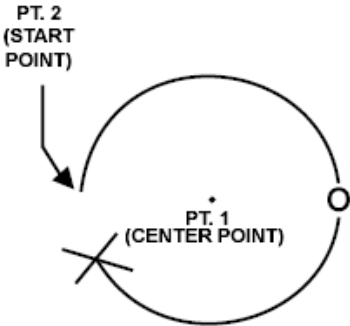
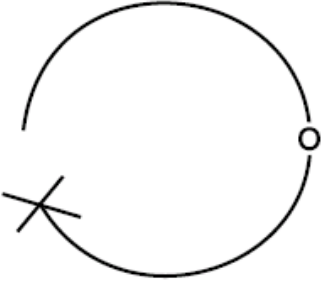

CONTROL MEASURE	TEMPLATE	DRAW RULES	EXAMPLE Note: The symbols that have been colored grey are used to help explain how the control measure is used, but they are not a part of the control measure.
<p>Relief in Place (RIP)</p> <p>Symbol Set Code: 25 Code: 341900</p> <p>Static/Dynamic: D</p>	 <p>The template diagram shows the 'RIP' symbol with four anchor points: PT. 1 at the tip of the top arrow, PT. 2 at the end of the top arrow, PT. 3 at the tip of the bottom arrow, and PT. 4 at the end of the bottom arrow. A smooth, curved line connects PT. 2 and PT. 3. The text 'RIP' is centered between the two arrows.</p>	<p><u>Anchor Points.</u> This symbol requires four anchor points. Point 1 defines the tip of the first arrowhead. Point 2 defines the end of the straight line portion of the first arrow. Point 3 defines the tip of the second arrowhead. Point 4 defines the end of the second arrow.</p> <p><u>Size/Shape.</u> Points 1 and 2 and points 3 and 4 determine the length of each arrow. Points 2 and 3 shall be connected by a smooth, curved line.</p> <p><u>Orientation.</u> Determined by the anchor points. The unit being relieved is typically located at the base of the curve and the unit performing the relief is typically located at the end of the symbol. The arrowhead typically points to the location the relieved unit should move to.</p>	 <p>The example diagram shows the 'RIP' symbol with two units represented by boxes with an 'x' mark. One unit is at the base of the curve, and the other is at the end of the symbol. The arrows point towards the unit at the end of the symbol.</p>

TABLE H-XXIV. Mission Task Symbols - Continued.

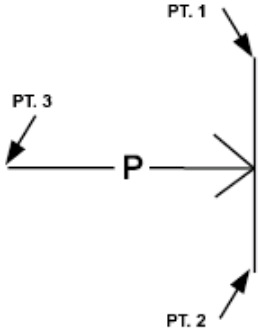
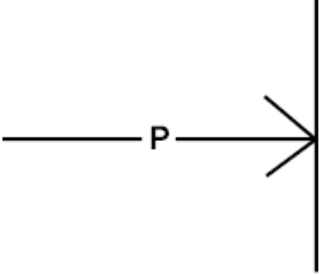
CONTROL MEASURE	TEMPLATE	DRAW RULES	EXAMPLE Note: The symbols that have been colored grey are used to help explain how the control measure is used, but they are not a part of the control measure.
<p>Retire/ Retirement</p> <p>Symbol Set Code: 25 Code: 342000</p> <p>Static/Dynamic: D</p>		<p><u>Anchor Points.</u> This symbol requires three anchor points. Point 1 defines the tip of the arrowhead. Point 2 defines the end of the straight line portion of the symbol. Point 3 defines the diameter and orientation of the 180 degree arc.</p> <p><u>Size/Shape.</u> Points 1 and 2 determine the length of the straight line portion of the symbol. Point 3 defines which side of the line the arc is on and the diameter of the arc.</p> <p><u>Orientation.</u> The arrow points in the direction of the action. The tip of the arrowhead may indicate the location where the action is to conclude. The unit's current location is typically represented at the base of the arc. The 180 degree circular arc is always perpendicular to the line.</p>	

TABLE H-XXIV. Mission Task Symbols - Continued.

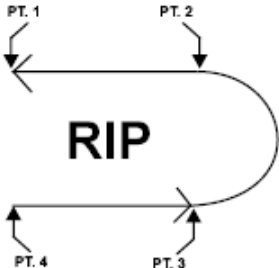

CONTROL MEASURE	TEMPLATE	DRAW RULES	EXAMPLE Note: The symbols that have been colored grey are used to help explain how the control measure is used, but they are not a part of the control measure.
<p>Secure</p> <p>Symbol Set Code: 25 Code: 342100</p> <p>Static/Dynamic: D</p>		<p><u>Anchor Points.</u> This graphic requires two anchor points. Point 1 defines the center point of the graphic and point 2 defines the graphic's start point and radius. <u>Size/Shape.</u> Points 1 and 2 will determine a radius that is long enough for the graphic to encompass the feature(s) being secured. The opening will be a 30-degree arc of the circle. <u>Orientation.</u> The opening will be on the friendly side of the graphic.</p>	
<p>Security</p> <p>Symbol Set Code: 25 Code: 342200</p>	<p>N/A</p>		<p>N/A</p>
<p>Cover</p> <p>Symbol Set Code: 25 Code: 342201</p> <p>Static/Dynamic: D</p>		<p><u>Anchor Points.</u> Where four points are available Point 1 and Point 2 define the ends of one arrow and Point 3 and Point 4 define the ends of the other arrow. Point 1 and Point 4 define the ends of</p>	

TABLE H-XXIV. Mission Task Symbols - Continued.

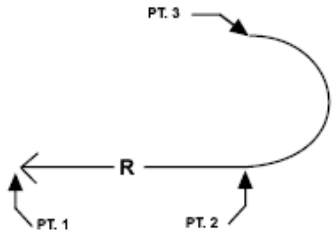
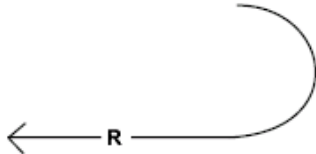
CONTROL MEASURE	TEMPLATE	DRAW RULES	EXAMPLE Note: The symbols that have been colored grey are used to help explain how the control measure is used, but they are not a part of the control measure.
		<p>their respective arrowheads. Where three points are available Point 1 defines the vertex of the graphic. Points 2 and 3 define the tips of the arrowheads.</p> <p><u>Size/Shape.</u> Where four points are available</p>	
<p>Guard</p> <p>Symbol Set Code: 25 Code: 342202</p> <p>Static/Dynamic: D</p>	 	<p>Points 1 and 2 and Points 3 and 4 determine the length of the arrows. Where three points are available Points 1 and 2 and points 1 and 3 determine the length of the arrows. The length and orientation of the arrows can vary independently.</p> <p><u>Orientation.</u> Orientation is determined by the anchor points. The arrowheads may touch other graphics that define the limits of the task. The</p>	 

TABLE H-XXIV. Mission Task Symbols - Continued.

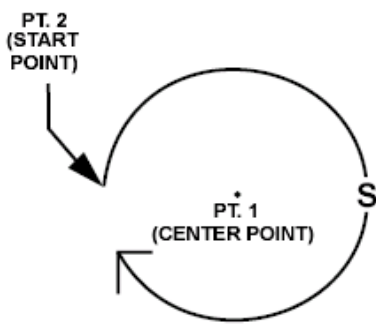
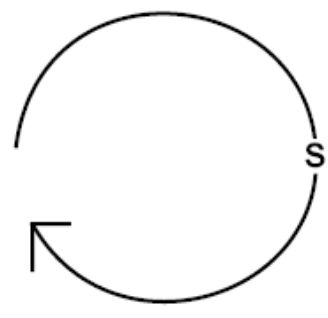
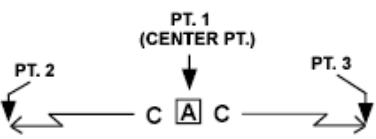
CONTROL MEASURE	TEMPLATE	DRAW RULES	EXAMPLE Note: The symbols that have been colored grey are used to help explain how the control measure is used, but they are not a part of the control measure.
<p>Screen</p> <p>Symbol Set Code: 25 Code: 342203</p> <p>Static/Dynamic: D</p>		<p>tactical symbol indicator is centered between point 2 and point 3 when four points are in use or centered on Point 1 when three points are in use.</p>	
<p>Seize</p> <p>Symbol Set Code: 25 Code: 342300</p> <p>Static/Dynamic: D</p>		<p><u>Anchor Points.</u> Where four points are available Point 1 defines the center of the circle. Point 2 defines the radius of the circle. Point 3 defines the curvature of the arc. Point 4 defines the end of the arrow. Where three points are available Point 1 defines the center point of the circle. Point 2 defines the tip of the arrowhead. Point 3 defines</p>	

TABLE H-XXIV. Mission Task Symbols - Continued.

CONTROL MEASURE	TEMPLATE	DRAW RULES	EXAMPLE Note: The symbols that have been colored grey are used to help explain how the control measure is used, but they are not a part of the control measure.
		<p>the 90 degree arc.</p> <p><u>Size/Shape.</u> Where four points are available Points 1 and 2 define the size of the circle, which should be adjusted as needed to contain the unit assigned the task. Point 3 controls the curvature of the arc. Point 4 defines the end of the arrow. Where three points are available Points 1 and 2 are connected by a 90 degree arc. The circle will at least be large enough to accommodate a tactical symbol. Point 3 indicates on which side of the line the arc is placed.</p> <p><u>Orientation.</u> The arrowhead identifies the location/object to be seized and the circle identifies the unit(s) assigned the task. See paragraph 5.3.11 for options to accommodate multiple units.</p>	

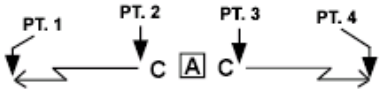
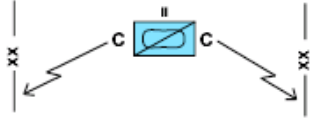
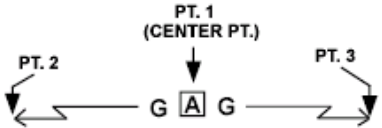
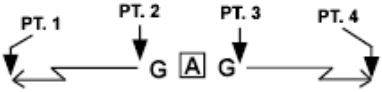
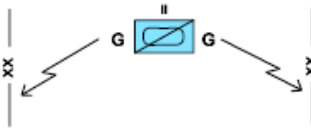
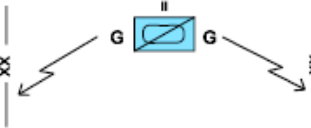
TABLE H-XXIV. Mission Task Symbols - Continued.

CONTROL MEASURE	TEMPLATE	DRAW RULES	EXAMPLE Note: The symbols that have been colored grey are used to help explain how the control measure is used, but they are not a part of the control measure.
<p>Withdraw</p> <p>Symbol Set Code: 25 Code: 342400</p> <p>Static/Dynamic: D</p>		<p><u>Anchor Points.</u> This graphic requires three anchor points. Point 1 defines the tip of the arrowhead. Point 2 defines the end of the straight line portion of the graphic. Point 3 defines the diameter and orientation of the</p>	
<p>Withdraw Under Pressure</p> <p>Symbol Set Code: 25 Code: 342500</p> <p>Static/Dynamic: D</p>		<p>180 degree circular arc. <u>Size/Shape.</u> Points 1 and 2 determine the length of the straight line portion of the symbol. Point 3 defines which side of the line the arc is on and the diameter of the arc. <u>Orientation.</u> The arrow points in the direction of the action. The tip of the arrowhead may indicate the location where the action is to conclude. The unit's current location is typically represented at the base of the arc. The 180 degree circular arc is always perpendicular to the line.</p>	

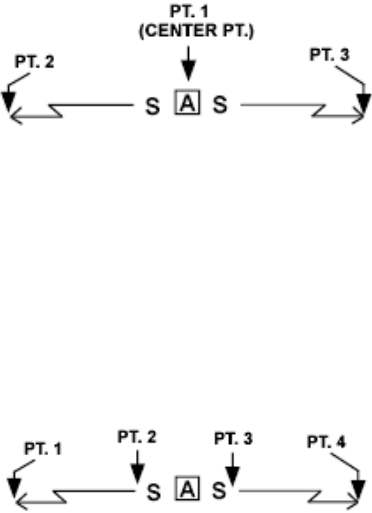
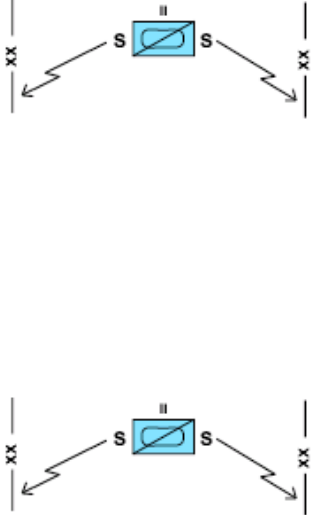
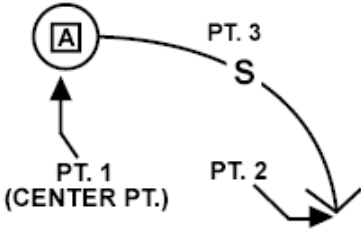
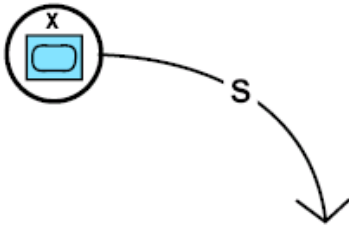
H.5.27 Intelligence control measures.

H.5.27.1 Intelligence control measure symbols. Support the planning, execution and support the acquisition of timely, tailored and accurate intelligence in relation with the commander's mission.

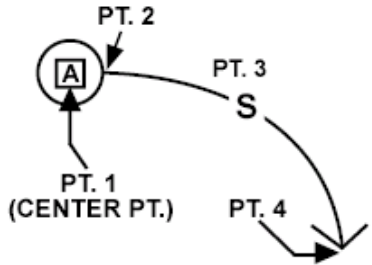
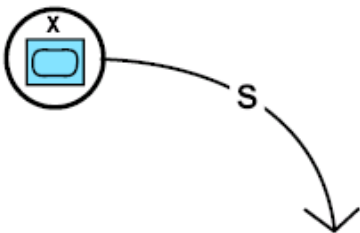
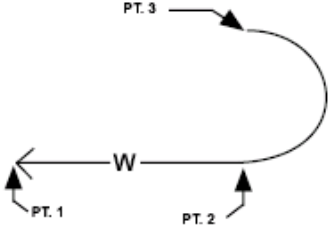
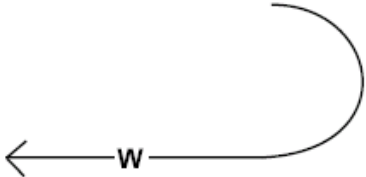
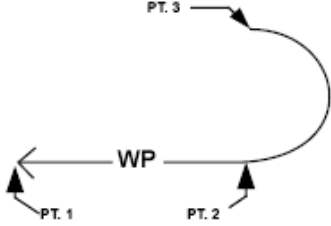
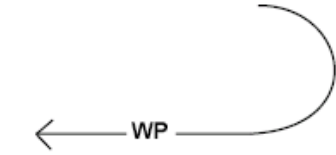
TABLE H-XXV. Intelligence control measure symbols.

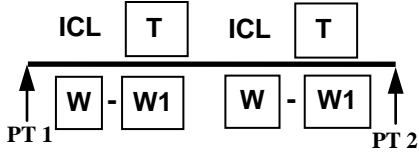
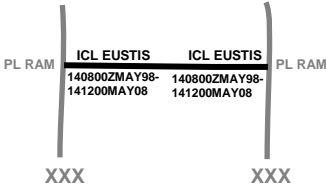
CONTROL MEASURE	TEMPLATE	DRAW RULES	EXAMPLE Note: The symbols that have been colored grey are used to help explain how the control measure is used, but they are not a part of the control measure.
<p>Intelligence Lines</p> <p>Symbol Set Code: 25 Code: 300000</p>	<p>N/A</p>		<p>N/A</p>
<p>Intelligence Coordination Line (ICL)</p> <p>Symbol Set Code: 25 Code: 300100</p> <p>Static/ Dynamic: D</p>		<p><u>Anchor Points.</u> This symbol requires at least two points, points 1 and 2, to define the line. Additional points can be defined to extend the line.</p> <p><u>Size/Shape.</u> The first and last anchor points determine the length of the line. The end-of line information will typically be posted at the ends of the line as it is displayed on the screen.</p> <p><u>Orientation.</u> Orientation is determined by the the order in which the anchor points are entered.</p>	

MIL-STD-2525D - APPENDIX H

H.5.28 Abbreviations and Acronyms for Use with Control Measure Symbols.

H.5.28.1 Boundary abbreviations and acronyms. [Table H-XXIII](#) below provides a list of abbreviations and acronyms for echelons and functional organizations to be used with boundaries.

TABLE H-XXVI. Abbreviations and acronyms for use with boundaries.

ECHELON	ABBREVIATION /ACRONYM	EXAMPLES Note: Any Unit identification can be followed by a 3 letter country code in parenthesis.
Army Group	AG (AAP-15)	1AG
Army	A (AAP-15)	3A
Corps	Does not require an abbreviation. Corps is the only echelon to use Roman numerals.	II
Marine Expeditionary Force	MEF (AAP-15)	III MEF (Use Roman numerals)
Marine Air-Ground Task Force	MAGTF (AAP-15)	4MAGTF
Division	DIV (AAP-15)	1DIV
Air Assault Division	AAD	101AAD
Airborne Division	ABD (AAP-15)	6ABD
Armored Division	AD (AAP-15)	2AD
Cavalry Division	CD	1CD
Infantry Division	ID (AAP-15)	52ID
Marine Division	MARD	1MARD
Mechanized Division	MD (AAP-15)	4MD
Mountain Division	MTND	10MTND
Multinational Division	MND (AAP-15)	1MND or MND(S).
Note: Multinational divisions may use geographical references in parenthesis		
Brigade	BDE (AAP-15)	2BDE
Air Assault Brigade	AAB (AAP-15)	8AAB
Airborne Brigade	ABB (AAP-15)	3ABB
Marine Expeditionary Brigade	MEB (AAP-15)	6MEB
Multinational Brigade	MNB (AAP-15)	2MNB
Naval Infantry Brigade	NIB (AAP-15)	4NIB
Regiment	REGT (AAP-15)	21REGT
Airborne Regiment	ABR (AAP-15)	901ABR
Marine Expeditionary Unit	MEU (AAP-15)	3MEU
Group	GP	41GP
Battle Group	BG (AAP-15)	5BG
Battalion	BN (AAP-15)	7BN
Company	COY (AAP-15)	ACoy or 2COY
Platoon	PLT	2PLT
Team	TM	BTM

H.5.28.2 Unit functions abbreviation and acronyms. [Table H-XXIV](#) provides a list of abbreviations and acronyms for unit functions to be used with control measures. The asterisk behind the abbreviation indicates that it is in AAP-15.

TABLE H-XXVII. Abbreviation and acronyms used in control measure symbols for unit functions.

Function	Abbreviation /Acronyms
Air Defense	<i>ADA*</i>
Antitank/Anti armor	<i>AT*</i>
Armor	<i>AR*</i>
Aviation	<i>AVN*</i>
Chemical Biological Radiological Nuclear (CBRN)	<i>CB</i>
Civil Affairs	<i>CA*</i>
Combined Arms	<i>CAR</i>
Counterintelligence	<i>CI*</i>
Electronic Warfare	<i>EW*</i>
Engineer	<i>EN</i>
Explosive Ordnance Disposal	<i>EOD*</i>
Field Artillery	<i>FA*</i>
Infantry	<i>IN</i>
Logistics	<i>LOG*</i>
Maintenance	<i>MNT</i>
Medical	<i>MED*</i>
Military Intelligence	<i>MI*</i>
Military Police	<i>MP*</i>
Naval	<i>NAV</i>
Ordnance	<i>ORD</i>
Quartermaster	<i>QM</i>
Reconnaissance	<i>REC</i>
Signal	<i>SIG</i>
Special Forces/	<i>SF</i>
Special Operations Force	<i>SOF</i>
Surveillance	<i>SUR</i>
Sustainment	<i>SUST</i>
Transportation	<i>TPT</i>

APPENDIX I - METEOROLOGICAL AND OCEANOGRAPHIC SYMBOLOGY

I.1 SCOPE

I.1.1 Scope. This appendix addresses control measure symbols in the meteorological and oceanographic (METOC) domain. Although the symbology in this domain is outside the configuration management of the Symbology Standards Management Committee (SSMC), it is beneficial to present the information to users of this standard as a separate appendix. This appendix has been coordinated and approved by the joint METOC community and is a mandatory part of this standard. The information contained herein is intended for compliance.

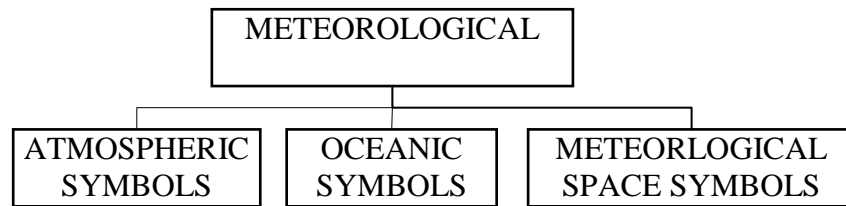

FIGURE I-1. Meteorological and oceanographic appendix sections

I.2 APPLICABLE DOCUMENTS

Specific documents in [2.2](#) of this standard apply to this appendix.

I.3 DEFINITIONS

The definitions in [section 3](#) of this standard apply to this appendix.

I.4 GENERAL REQUIREMENTS

I.4.1 Organization. This appendix contains technical specifications, a symbol coding scheme, a symbology hierarchy and METOC symbology.

I.5 DETAILED REQUIREMENTS

I.5.1 Technical specifications. Composition, construction and display of symbols are explained in the detailed requirements section of the standard.

I.5.2 Symbology identification coding scheme. A symbol identification code (SIDC) is a numeric string that may be used to provide the unique identifier necessary to display or exchange symbol information between MIL-STD-2525 compliant systems. Refer to [Appendix A](#) for SIDC positions and descriptions.

I.5.3 Symbology set. The following graphics are some of those more commonly used to depict weather and should only be used on weather-related displays. These graphics must be implemented as a separate layer or classification since they may conflict with other symbols or icons used in the warrior icon set. These graphics are based on approved symbols and icons from the World Meteorological Organization (WMO).

TABLE I-I. Atmospheric icons.



DESCRIPTION	ICON	DRAW RULES
<p>PRESSURE SYSTEMS</p> <p>Static/Dynamic: N/A Symbol Set Code: 45 Code: 110000</p>	<p>N/A</p>	<p>N/A</p>
<p>PRESSURE SYSTEMS LOW PRESSURE CENTER</p> <p>Static/Dynamic: D Symbol Set Code: 45 Code: 110100</p> <p>Color: Red (RGB 255,0,0)</p>		<p><u>Anchor Points.</u> This graphic requires one anchor point. The center point defines the center of the graphic.</p> <p><u>Size/Shape.</u> Scalable.</p> <p><u>Orientation.</u> The graphic is typically centered over the represented pressure center.</p> <p>Note: The graphic is a letter 'L' with a dynamic tag 'P' below it that represents the lowest atmospheric pressure of the system. The value is three or 4 digits and represents the pressure in hectoPascals (millibars). The value below, 998, represents 998 hectoPascals. A value above 1000 HectoPascals would be reflected in 4 digits like 1008 hectoPascals.</p>
<p>PRESSURE SYSTEMS LOW PRESSURE CENTER CYCLONE CENTER</p> <p>Static/Dynamic: S Symbol Set Code: 45 Code: 110101</p> <p>Color: Red (RGB 255,0,0)</p>		<p><u>Anchor Points.</u> This graphic requires one anchor point. The center point defines the center of the graphic.</p> <p><u>Size/Shape.</u> Scalable.</p> <p><u>Orientation.</u> The graphic is typically centered over the represented pressure center.</p> <p>Note: The graphic is a letter 'C' that represents the atmospheric circulation center of the system.</p>

TABLE I-I. Atmospheric icons - Continued.



DESCRIPTION	ICON	DRAW RULES
<p>PRESSURE SYSTEMS LOW PRESSURE CENTER TROPOPAUSE LOW</p> <p>Static/Dynamic: D Symbol Set Code: 45 Code: 110102</p> <p>Color: Black</p>		<p><u>Anchor Points.</u> This graphic requires one anchor point. The center point defines the center of the graphic.</p> <p><u>Size/Shape.</u> Scalable.</p> <p><u>Orientation.</u> The graphic is typically centered over the represented pressure center.</p> <p>Note: The center of the graphic is the pressure center. The low point of the tropopause topography is indicated by the letter 'L' and the height (H in 3 digits) above mean sea level in hundreds of feet (or meters) is included within the graphic</p>
<p>PRESSURE SYSTEMS HIGH PRESSURE CENTER</p> <p>Static/Dynamic: D Symbol Set Code: 45 Code: 110200</p> <p>Color: Blue (RGB 0,0,255)</p>		<p><u>Anchor Points.</u> This graphic requires one anchor point. The center point defines the center of the graphic.</p> <p><u>Size/Shape.</u> Scalable.</p> <p><u>Orientation.</u> The graphic is typically centered over the represented pressure center.</p> <p>Note: The graphic is a letter 'H' with a dynamic tag 'P' below it that represents the highest atmospheric pressure of the system. The value is three or four digits and represents the pressure in hectoPascals (millibars). The value below, 1016, represents 1016 hectoPascals. A value below 1000 HectoPascals would be reflected in three digits like 998 hectoPascals.</p>
<p>PRESSURE SYSTEMS HIGH PRESSURE CENTER ANTICYCLONE CENTER</p> <p>Static/Dynamic: S Symbol Set Code: 45 Code: 110201</p> <p>Color: Blue (RGB 0,0,255)</p>		<p><u>Anchor Points.</u> This graphic requires one anchor point. The center point defines the center of the graphic.</p> <p><u>Size/Shape.</u> Scalable.</p> <p><u>Orientation.</u> The graphic is typically centered over the represented pressure center</p> <p>Note: The graphic is a letter 'A' that represents the atmospheric circulation center of the system.</p>

TABLE I-I. Atmospheric icons - Continued.



DESCRIPTION	ICON	DRAW RULES
<p>PRESSURE SYSTEMS HIGH PRESSURE CENTER TROPOPAUSE HIGH</p> <p>Static/Dynamic: D Symbol Set Code: 45 Code: 110202</p> <p>Color: Black</p>		<p><u>Anchor Points.</u> This graphic requires one anchor point. The center point defines the center of the graphic.</p> <p><u>Size/Shape.</u> Scalable.</p> <p><u>Orientation.</u> The graphic is typically centered over the represented pressure center.</p> <p>Note: The center of the graphic is the pressure center. The high point of the tropopause topography is indicated by the letter 'H' and the height (X in 3 digits) above mean sea level in hundreds of feet (or meters) is included within the graphic.</p>
<p>PRESSURE SYSTEMS FRONTAL SYSTEMS</p> <p>Static/Dynamic: N/A Symbol Set Code: 45 Code: 110300</p>	<p>N/A</p>	<p>Note: For special lines that are not symmetrical, such as Fronts, the sequence of anchor points determines the proper alignment of the line. For two anchor points that describe the position of the front or a section of the front, with L (for left point) and R (for right point): (1) If R comes before L in sequence, the front is rendered in the way shown, (2) If L comes before R in sequence, the front is rendered in the reverse with pips shown facing the opposite direction.).</p>
<p>PRESSURE SYSTEMS FRONTAL SYSTEMS COLD FRONT</p> <p>Static/Dynamic: D Symbol Set Code: 45 Code: 110301</p> <p>Color: Blue (RGB 0,0,255)</p>		<p><u>Anchor Points.</u> This graphic requires at least two anchor points, points 1 and 2, to define the line. Additional points can be defined to extend the line.</p> <p><u>Size/Shape.</u> Scalable/Curve. The points are typically connected with a curved line with solid, triangular pips spaced evenly along the line. The curvature of the line is operator defined.</p> <p><u>Orientation.</u> The first and last anchor points determine the length of the line. The line should be drawn from the pressure center to the extent of the front. The pips will be evenly spaced.</p>

TABLE I-I. Atmospheric icons - Continued.



DESCRIPTION	ICON	DRAW RULES
<p>PRESSURE SYSTEMS FRONTAL SYSTEMS COLD FRONT UPPER COLD FRONT</p> <p>Static/Dynamic: D Symbol Set Code: 45 Code: 110302</p> <p>Color: Blue (RGB 0,0,255)</p>		<p><u>Anchor Points.</u> This graphic requires at least two anchor points, points 1 and 2, to define the line. Additional points can be defined to extend the line.</p> <p><u>Size/Shape.</u> Scalable/Curve. The points are typically connected with a curved line with solid, triangular pips spaced evenly along the line. The curvature of the line is operator defined.</p> <p><u>Orientation.</u> The first and last anchor points determine the length of the line. The line should be drawn from the pressure center to the extent of the front. The pips will be evenly spaced.</p>
<p>PRESSURE SYSTEMS FRONTAL SYSTEMS COLD FRONT COLD FRONTOGENESIS</p> <p>Static/Dynamic: D Symbol Set Code: 45 Code: 110303</p> <p>Color: Blue (RGB 0,0,255)</p>		<p><u>Anchor Points.</u> This graphic requires at least two anchor points, points 1 and 2, to define the line. Additional points can be defined to extend the line.</p> <p><u>Size/Shape.</u> Scalable/Curve. The points are typically connected with a curved line with solid, triangular pips spaced evenly along the line. The curvature of the line is operator defined.</p> <p><u>Orientation.</u> The first and last anchor points determine the length of the line. The line should be drawn from the pressure center to the extent of the front. The pips will be evenly spaced along the line. Pips point in the direction the front is moving.</p>

TABLE I-I. Atmospheric icons - Continued.



DESCRIPTION	ICON	DRAW RULES
<p>PRESSURE SYSTEMS FRONTAL SYSTEMS COLD FRONT COLD FRONTOLYSIS</p> <p>Static/Dynamic: D Symbol Set Code: 45 Code: 110304</p> <p>Color: Blue (RGB 0,0,255)</p>		<p><u>Anchor Points.</u> This graphic requires at least two anchor points, points 1 and 2, to define the line. Additional points can be defined to extend the line.</p> <p><u>Size/Shape.</u> Scalable/Curve. The points are typically connected with a curved line with solid, triangular pips spaced evenly along the line separated by a crossed line. The curvature of the line is operator defined.</p> <p><u>Orientation.</u> The first and last anchor points determine the length of the line. The line should be drawn from the pressure center to the extent of the front. The pips will be evenly spaced along the line. Pips point in the direction the front is moving.</p> <p>Note: Frontolysis is the process where a frontal system is dissipating/weakening</p>
<p>PRESSURE SYSTEMS FRONTAL SYSTEMS WARM FRONT</p> <p>Static/Dynamic: D Symbol Set Code: 45 Code: 110305</p> <p>Color: Red (RGB 255,0,0)</p>		<p><u>Anchor Points.</u> This graphic requires at least two anchor points, points 1 and 2, to define the line. Additional points can be defined to extend the line.</p> <p><u>Size/Shape.</u> Scalable/Curve. The points are typically connected with a curved line with solid, half-circle pips spaced evenly along the line. The curvature of the line is operator defined.</p> <p><u>Orientation.</u> The first and last anchor points determine the length of the line. The line should be drawn from the pressure center to the extent of the front. The pips will be evenly spaced along the line. Pips point in the direction the front is moving.</p>

TABLE I-I. Atmospheric icons - Continued.



DESCRIPTION	ICON	DRAW RULES
<p>PRESSURE SYSTEMS FRONTAL SYSTEMS WARM FRONT UPPER WARM FRONT</p> <p>Static/Dynamic: D Symbol Set Code: 45 Code: 110306</p> <p>Color: Red (RGB 255,0,0)</p>		<p><u>Anchor Points.</u> This graphic requires at least two anchor points, points 1 and 2, to define the line. Additional points can be defined to extend the line.</p> <p><u>Size/Shape.</u> Scalable/Curve. The points are typically connected with a curved line with solid, half-circle pips spaced evenly along the line. The curvature of the line is operator defined.</p> <p><u>Orientation.</u> The first and last anchor points determine the length of the line. The line should be drawn from the pressure center to the extent of the front. The pips will be evenly spaced along the line. Pips point in the direction the front is moving.</p>
<p>PRESSURE SYSTEMS FRONTAL SYSTEMS WARM FRONT WARM FRONTOGENESIS</p> <p>Static/Dynamic: D Symbol Set Code: 45 Code: 110307</p> <p>Color: Red (RGB 255,0,0)</p>		<p><u>Anchor Points.</u> This graphic requires at least two anchor points, points 1 and 2, to define the line. Additional points can be defined to extend the line.</p> <p><u>Size/Shape.</u> Scalable/Curve. The points are typically connected with a curved line with solid, half-circle pips spaced evenly along the line separated by one dot. The curvature of the line is operator defined.</p> <p><u>Orientation.</u> The first and last anchor points determine the length of the line. The line should be drawn from the pressure center to the extent of the front. The pips will be evenly spaced along the line. Pips point in the direction the front is moving.</p> <p>Note: Frontogenesis is the process where a frontal boundary is developing..</p>

TABLE I-I. Atmospheric icons - Continued.



DESCRIPTION	ICON	DRAW RULES
<p>PRESSURE SYSTEMS FRONTAL SYSTEMS WARM FRONT WARM FRONTOLYSIS</p> <p>Static/Dynamic: D Symbol Set Code: 45 Code: 110308</p> <p>Color: Red (RGB 255,0,0)</p>		<p><u>Anchor Points.</u> This graphic requires at least two anchor points, points 1 and 2, to define the line. Additional points can be defined to extend the line.</p> <p><u>Size/Shape.</u> Scalable/Curve. The points are typically connected with a curved line with solid, half-circle pips spaced evenly along the line separated by a crossed line. The curvature of the line is operator defined</p> <p><u>Orientation.</u> The first and last anchor points determine the length of the line. The line should be drawn from the pressure center to the extent of the front. The pips will be evenly spaced along the line. Pips point in the direction the front is moving.</p> <p>Note: Frontolysis is the process where a frontal system is dissipating/weakening.</p>
<p>PRESSURE SYSTEMS FRONTAL SYSTEMS OCCLUDED FRONT</p> <p>Static/Dynamic: D Symbol Set Code: 45 Code: 110309</p> <p>Color: Purple (RGB 111,49,152)</p>		<p><u>Anchor Points.</u> This graphic requires at least two anchor points, points 1 and 2, to define the line. Additional points can be defined to extend the line.</p> <p><u>Size/Shape.</u> Scalable/Curve. The points are typically connected with a curved line with alternating solid, triangular and half-circle pips spaced evenly along the line. The curvature of the line is operator defined.</p> <p><u>Orientation.</u> The first and last anchor points determine the length of the line. The line should be drawn from the pressure center to the extent of the front. The pips will be evenly spaced along the line. Pips point in the direction the front is moving.</p> <p>Note: An occluded front is where a cold front has overtaken a warm front and is the discontinuity between colder air and cooler air and the colder air forces the cooler air aloft.</p>

TABLE I-I. Atmospheric icons - Continued.



DESCRIPTION	ICON	DRAW RULES
<p>PRESSURE SYSTEMS FRONTAL SYSTEMS OCCLUDED FRONT UPPER OCCLUDED FRONT</p> <p>Static/Dynamic: D Symbol Set Code: 45 Code: 110310</p> <p>Color: Purple (RGB 111,49,152)</p>		<p><u>Anchor Points.</u> This graphic requires at least two anchor points, points 1 and 2, to define the line. Additional points can be defined to extend the line.</p> <p><u>Size/Shape.</u> Scalable/Curve. The points are typically connected with a curved line with alternating hollow, triangular and half-circle pips spaced evenly along the line. The curvature of the line is operator defined.</p> <p><u>Orientation.</u> The first and last anchor points determine the length of the line. The line should be drawn from the pressure center to the extent of the front. The pips will be evenly spaced along the line. Pips point in the direction the front is moving.</p>
<p>PRESSURE SYSTEMS FRONTAL SYSTEMS OCCLUDED FRONT OCCLUDED FRONTOLYSIS</p> <p>Static/Dynamic: D Symbol Set Code: 45 Code: 110311</p> <p>Color: Purple (RGB 111,49,152)</p>		<p><u>Anchor Points.</u> This graphic requires at least two anchor points, points 1 and 2, to define the line. Additional points can be defined to extend the line.</p> <p><u>Size/Shape.</u> Scalable/Curve. The points are typically connected with a curved line with alternating solid, triangular and half-circle pips spaced evenly along the line separated by a crossed line. The curvature of the line is operator defined.</p> <p><u>Orientation.</u> The first and last anchor points determine the length of the line. The line should be drawn from the pressure center to the extent of the front. The pips will be evenly spaced along the line. Pips point in the direction the front is moving.</p> <p>Note: Frontolysis is the process where a frontal system is dissipating/weakening.</p>

TABLE I-I. Atmospheric icons - Continued.



DESCRIPTION	ICON	DRAW RULES
<p>PRESSURE SYSTEMS FRONTAL SYSTEMS STATIONARY FRONT</p> <p>Static/Dynamic: D Symbol Set Code: 45 Code: 110312</p> <p>Color: Alternate Red (RGB 255,0,0) & Blue (RGB 0,0,255)</p>		<p><u>Anchor Points.</u> This graphic requires at least two anchor points, points 1 and 2, to define the line. Additional points can be defined to extend the line.</p> <p><u>Size/Shape.</u> Scalable/Curve. The points are typically connected with a curved line with solid, triangular and half-circle pips spaced evenly on alternating sides of the line. The curvature of the line is operator defined.</p> <p><u>Orientation.</u> The first and last anchor points determine the length of the line. The line should be drawn from the pressure center to the extent of the front. The pips will be evenly spaced. Since the front is not moving, pips alternate with warm (red) pointing one direction (normally to left or up) and the cold (blue) pointing the other (normally right or down).</p>
<p>PRESSURE SYSTEMS FRONTAL SYSTEMS STATIONARY FRONT UPPER STATIONARY FRONT</p> <p>Static/Dynamic: D Symbol Set Code: 45 Code: 110313</p> <p>Color: Alternate Red (RGB 255,0,0) & Blue (RGB 0,0,255)</p>		<p><u>Anchor Points.</u> This graphic requires at least two anchor points, points 1 and 2, to define the line. Additional points can be defined to extend the line.</p> <p><u>Size/Shape.</u> Scalable/Curve. The points are typically connected with a curved line with hollow, triangular and half-circle pips spaced evenly on alternating sides of the line. The curvature of the line is operator defined.</p> <p><u>Orientation.</u> The first and last anchor points determine the length of the line. The line should be drawn from the pressure center to the extent of the front. The pips will be evenly spaced along the line. Since the front is not moving, pips alternate with warm (red) pointing one direction (normally to left or up) and the cold (blue) pointing the other (normally right or down).</p>

TABLE I-I. Atmospheric icons - Continued.



DESCRIPTION	ICON	DRAW RULES
<p>PRESSURE SYSTEMS FRONTAL SYSTEMS STATIONARY FRONT STATIONARY FRONTOGENESIS</p> <p>Static/Dynamic: D Symbol Set Code: 45 Code: 110314</p> <p>Color: Alternate Red (RGB 255,0,0) & Blue (RGB 0,0,255)</p>		<p><u>Size/Shape</u>. Scalable/Curve. The points are typically connected with a curved line with solid, triangular and half-circle pips spaced evenly on alternating sides of the line separated by one dot. The curvature of the line is operator defined.</p> <p><u>Orientation</u>. The first and last anchor points determine the length of the line. The line should be drawn from the pressure center to the extent of the front. The pips will be evenly spaced along the line. Since the front is not moving, pips alternate with warm (red) pointing one direction (normally to left or up) and the cold (blue) pointing the other (normally right or down).</p>
<p>PRESSURE SYSTEMS FRONTAL SYSTEMS STATIONARY FRONT STATIONARY FRONTOLYSIS</p> <p>Static/Dynamic: D Symbol Set Code: 45 Code: 110315</p> <p>Color: Alternate Red (RGB 255,0,0) & Blue (RGB 0,0,255)</p>		<p><u>Anchor Points</u>. This graphic requires at least two anchor points, points 1 and 2, to define the line. Additional points can be defined to extend the line.</p> <p><u>Size/Shape</u>. Scalable/Curve. The points are typically connected with a curved line with solid, triangular and half-circle pips spaced evenly on alternating sides of the line separated by a crossed line. The curvature of the line is operator defined.</p> <p><u>Orientation</u>. The first and last anchor points determine the length of the line. The line should be drawn from the pressure center to the extent of the front. The pips will be evenly spaced. Since the front is not moving, pips alternate with warm (red) pointing one direction (normally to left or up) and the cold (blue) pointing the other (normally right or down)..</p>
<p>PRESSURE SYSTEMS LINES</p> <p>Static/Dynamic: N/A Symbol Set Code: 45 Code: 110400</p>	<p>N/A</p>	

TABLE I-I. Atmospheric icons - Continued.



DESCRIPTION	ICON	DRAW RULES
<p>PRESSURE SYSTEMS LINES TROUGH AXIS</p> <p>Static/Dynamic: D Symbol Set Code: 45 Code: 110401</p> <p>Color: Black</p>		<p><u>Anchor Points</u>. This graphic requires at least two anchor points, points 1 and 2, to define the line. Additional points can be defined to extend the line.</p> <p><u>Size/Shape</u>. Scalable/Curve. The points are typically connected with a dashed curved line. The curvature of the line is operator defined.</p> <p><u>Orientation</u>. The first and last anchor points determine the length of the line. The line should be drawn along the trough axis.</p> <p>Note: This is a surface feature.</p>
<p>PRESSURE SYSTEMS LINES UPPER TROUGH AXIS</p> <p>Static/Dynamic: D Symbol Set Code: 45 Code: 110402</p> <p>Color: Black</p>		<p><u>Anchor Points</u>. This graphic requires at least two anchor points, points 1 and 2, to define the line. Additional points can be defined to extend the line.</p> <p><u>Size/Shape</u>. Scalable/Curve. The points are typically connected with a solid curved line. The curvature of the line is operator defined.</p> <p><u>Orientation</u>. The first and last anchor points determine the length of the line. The line should be drawn along the trough axis.</p>
<p>PRESSURE SYSTEMS LINES RIDGE AXIS</p> <p>Static/Dynamic: D Symbol Set Code: 45 Code: 110403</p> <p>Color: Black</p>		<p><u>Anchor Points</u>. This graphic requires at least two anchor points, points 1 and 2, to define the line. Additional points can be defined to extend the line.</p> <p><u>Size/Shape</u>. Scalable/Curve. The points are typically connected with a solid zigzag line. The zigzag of the line is operator defined.</p> <p><u>Orientation</u>. The first and last anchor points determine the length of the line. The line should be drawn along the ridge axis. The zigzag of the line will be placed at regular intervals along the entire length of the line.</p>

TABLE I-I. Atmospheric icons - Continued.

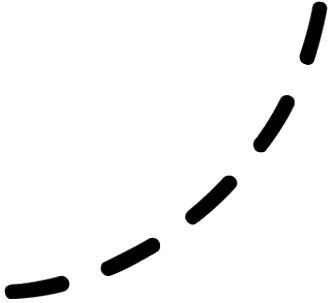

DESCRIPTION	ICON	DRAW RULES
<p>PRESSURE SYSTEMS LINES SEVERE SQUALL LINE</p> <p>Static/Dynamic: D Symbol Set Code: 45 Code: 110404</p> <p>Color: Black</p>		<p><u>Anchor Points.</u> This graphic requires at least two anchor points, points 1 and 2, to define the line. Additional points can be defined to extend the line.</p> <p><u>Size/Shape.</u> Scalable/Curve. The points are typically connected with a straight line consisting of a short line section and an alternating V shape. The curvature and amplitude of the waves of the line are operator defined.</p> <p><u>Orientation.</u> The first and last anchor points determine the length of the line. The line should be drawn so the "V" shapes are facing in the direction of movement. The "V" shapes and short line segment will alternate along the line.</p> <p>Note: This line type is rarely seen, but may appear in products from the Canadian meteorological service (Meteorological Services of Canada). The term "severe squall line" is generally implied by "squall line"</p>
<p>PRESSURE SYSTEMS LINES INSTABILITY LINE</p> <p>Static/Dynamic: D Symbol Set Code: 45 Code: 110405</p> <p>Color: Black</p>		<p><u>Anchor Points.</u> This graphic requires at least two anchor points, points 1 and 2, to define the line. Additional points can be defined to extend the line.</p> <p><u>Size/Shape.</u> Scalable/Curve. The points are typically connected with a straight line consisting of a short line section and alternating two dots. The curvature and amplitude of the waves of the line are operator defined.</p> <p><u>Orientation.</u> The first and last anchor points determine the length of the line. The two dots and the short line segment will alternate along the line.</p>

TABLE I-I. Atmospheric icons - Continued.



DESCRIPTION	ICON	DRAW RULES
<p>PRESSURE SYSTEMS LINES SHEAR LINE</p> <p>Static/Dynamic: D Symbol Set Code: 45 Code: 110406</p> <p>Color: Black</p>		<p><u>Anchor Points.</u> This graphic requires at least two anchor points, points 1 and 2, to define the line. Additional points can be defined to extend the line.</p> <p><u>Size/Shape.</u> Scalable/Curve. The points are typically connected with a curved/wavy line consisting of a short line and one dot. The curvature and amplitude of the waves of the line are operator defined.</p> <p><u>Orientation.</u> The first and last anchor points determine the length of the line. The dot and the short line segment will alternate along the line.</p> <p>Note: A shear line is normally the convergent easterly winds where a cold front has intruded into a tropical region.</p>
<p>PRESSURE SYSTEMS LINES INTER-TROPICAL CONVERGANCE ZONE</p> <p>Static/Dynamic: D Symbol Set Code: 45 Code: 110407</p> <p>Color: Orange (RGB 255,128,0)</p>		<p><u>Anchor Points.</u> This graphic requires at least three anchor points to define the boundary of the area. Add as many points as necessary to accurately reflect the area's size and shape.</p> <p><u>Size/Shape.</u> Determined by the anchor points.</p> <p><u>Orientation.</u> The first and last anchor points determine the length of the line. The dual line segments will be parallel to slightly wider at the western end..</p> <p>Note: The operator should place the modifier(s) to indicate areas of weather activity within the graphic. The Inter-Tropical Convergence Zone (ITCZ) is a region where the northeasterly and southeasterly trade winds converge.</p>

TABLE I-I. Atmospheric icons - Continued.



DESCRIPTION	ICON	DRAW RULES
<p>PRESSURE SYSTEMS LINES CONVERGANCE LINE</p> <p>Static/Dynamic: D Symbol Set Code: 45 Code: 110408</p> <p>Color: Orange (RGB 255,128,0)</p>		<p><u>Anchor Points</u>. This graphic requires at least two anchor points, points 1 and 2, to define the line. Additional points can be defined to extend the line.</p> <p><u>Size/Shape</u>. Scalable/Curve. The points are typically connected with a solid straight line with alternating slanted lines connected as depicted in the example to indicate convergence.</p> <p><u>Orientation</u>. The first and last anchor points determine the length of the line. The alternating slanted lines will be evenly spaced along the line. Orientation is determined by the anchor points.</p>
<p>PRESSURE SYSTEMS LINES INTER-TROPICAL DISCONTINUITY</p> <p>Static/Dynamic: D Symbol Set Code: 45 Code: 110409</p> <p>Color: : Alternate Red (RGB 255,0,0) and Green (RGB 13,223,39)</p>		<p><u>Anchor Points</u>. This graphic requires at least two anchor points, points 1 and 2, to define the line. Additional points can be defined to extend the line.</p> <p><u>Size/Shape</u>. Scalable/Curve. The points are typically connected with a dashed straight or curved line. The curvature of the line is operator defined.</p> <p><u>Orientation</u>. The first and last anchor points determine the length of the line. The red and green line segments will alternate along the line. Orientation is determined by the anchor points.</p>
<p>PRESSURE SYSTEMS PRESSURE TENDENCY</p> <p>Static/Dynamic: D Symbol Set Code: 45 Code: 110500</p>	<p>N/A</p>	<p>Note: Each symbol within the pressure tendency group is static, but only one can be applied to a particular station plot, dependent upon the pressure tendency at that location. As such, the group of symbols is dynamic.</p>

TABLE I-I. Atmospheric icons - Continued.

DESCRIPTION	ICON	DRAW RULES
<p>PRESSURE SYSTEMS PRESSURE TENDENCY RISE THEN FALL HIGHER</p> <p>Static/Dynamic: D Symbol Set Code: 45 Code: 110501</p> <p>Color: Black / Blue (RGB 0,0,255)</p>		<p><u>Anchor Points:</u> This graphic requires one anchor point. The center point defines the geometric center of the graphic.</p> <p><u>Size/Shape:</u> Scalable.</p> <p><u>Orientation:</u> The graphic is centered over the anchor location.</p> <p>Note: Pressure tendency symbols are depicted to the right of the plot circle just after the text value for the actual pressure change.</p> <p>Pressure tendency is displayed in two digits in black immediately to right of the plot circle followed by the pressure tendency symbol.</p>
<p>PRESSURE SYSTEMS PRESSURE TENDENCY RISE THEN STEADY</p> <p>Static/Dynamic: D Symbol Set Code: 45 Code: 110502</p> <p>Color: Black / Blue (RGB 0,0,255)</p>		<p><u>Anchor Points:</u> This graphic requires one anchor point. The center point defines the geometric center of the graphic.</p> <p><u>Size/Shape:</u> Scalable.</p> <p><u>Orientation:</u> The graphic is centered over the anchor location.</p> <p>Note: Pressure tendency symbols are depicted to the right of the plot circle just after the text value for the actual pressure change.</p> <p>Pressure tendency is displayed in two digits in black immediately to right of the plot circle followed by the pressure tendency symbol.</p>

TABLE I-I. Atmospheric icons - Continued.



DESCRIPTION	ICON	DRAW RULES
<p>PRESSURE SYSTEMS PRESSURE TENDENCY RISE</p> <p>Static/Dynamic: D Symbol Set Code: 45 Code: 110503</p> <p>Color: Black / Blue (RGB 0,0,255)</p>		<p><u>Anchor Points:</u> This graphic requires one anchor point. The center point defines the geometric center of the graphic.</p> <p><u>Size/Shape:</u> Scalable.</p> <p><u>Orientation:</u> The graphic is centered over the anchor location.</p> <p>Note: Pressure tendency symbols are depicted to the right of the plot circle just after the text value for the actual pressure change.</p> <p>Pressure tendency is displayed in two digits in black immediately to right of the plot circle followed by the pressure tendency symbol.</p>
<p>PRESSURE SYSTEMS PRESSURE TENDENCY RISE THEN RISE HIGHER</p> <p>Static/Dynamic: D Symbol Set Code: 45 Code: 110504</p> <p>Color: Black / Blue (RGB 0,0,255)</p>		<p><u>Anchor Points:</u> This graphic requires one anchor point. The center point defines the geometric center of the graphic.</p> <p><u>Size/Shape:</u> Scalable.</p> <p><u>Orientation:</u> The graphic is centered over the anchor location.</p> <p>Note: Pressure tendency symbols are depicted to the right of the plot circle just after the text value for the actual pressure change.</p> <p>Pressure tendency is displayed in two digits in black immediately to right of the plot circle followed by the pressure tendency symbol.</p>

TABLE I-I. Atmospheric icons - Continued.

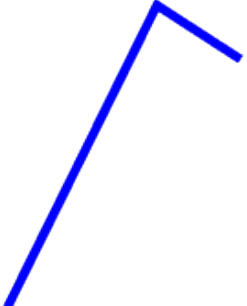
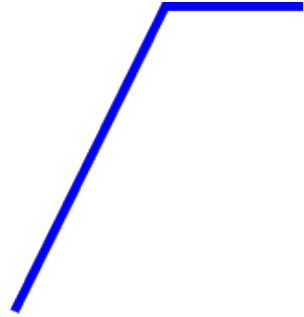

DESCRIPTION	ICON	DRAW RULES
<p>PRESSURE SYSTEMS PRESSURE TENDENCY STEADY</p> <p>Static/Dynamic: D Symbol Set Code: 45 Code: 110505</p> <p>Color: Black</p>		<p><u>Anchor Points:</u> This graphic requires one anchor point. The center point defines the geometric center of the graphic.</p> <p><u>Size/Shape:</u> Scalable.</p> <p><u>Orientation:</u> The graphic is centered over the anchor location.</p> <p>Note: Pressure tendency symbols are depicted to the right of the plot circle just after the text value for the actual pressure change.</p> <p>Pressure tendency is displayed in two digits in black immediately to right of the plot circle followed by the pressure tendency symbol.</p>
<p>PRESSURE SYSTEMS PRESSURE TENDENCY FALL THEN RISE LOWER</p> <p>Static/Dynamic: D Symbol Set Code: 45 Code: 110506</p> <p>Color: Black / Red (RGB 255,0,0)</p>		<p><u>Anchor Points:</u> This graphic requires one anchor point. The center point defines the geometric center of the graphic.</p> <p><u>Size/Shape:</u> Scalable.</p> <p><u>Orientation:</u> The graphic is centered over the anchor location.</p> <p>Note: Pressure tendency symbols are depicted to the right of the plot circle just after the text value for the actual pressure change.</p> <p>Pressure tendency is displayed in two digits in black immediately to right of the plot circle followed by the pressure tendency symbol.</p>
<p>PRESSURE SYSTEMS PRESSURE TENDENCY FALL THEN STEADY</p> <p>Static/Dynamic: D Symbol Set Code: 45 Code: 110507</p> <p>Color: Black / Red (RGB 255,0,0)</p>		<p><u>Anchor Points:</u> This graphic requires one anchor point. The center point defines the geometric center of the graphic.</p> <p><u>Size/Shape:</u> Scalable.</p> <p><u>Orientation:</u> The graphic is centered over the anchor location.</p> <p>Note: Pressure tendency symbols are depicted to the right of the plot circle just after the text value for the actual pressure change.</p> <p>Pressure tendency is displayed in two digits in black immediately to right of the plot circle followed by the pressure tendency symbol.</p>

TABLE I-I. Atmospheric icons - Continued.

DESCRIPTION	ICON	DRAW RULES
<p>PRESSURE SYSTEMS PRESSURE TENDENCY FALL</p> <p>Static/Dynamic: D Symbol Set Code: 45 Code: 110508</p> <p>Color: Black / Red (RGB 255,0,0)</p>		<p><u>Anchor Points:</u> This graphic requires one anchor point. The center point defines the geometric center of the graphic.</p> <p><u>Size/Shape:</u> Scalable.</p> <p><u>Orientation:</u> The graphic is centered over the anchor location.</p> <p>Note: Pressure tendency symbols are depicted to the right of the plot circle just after the text value for the actual pressure change. Pressure tendency is displayed in two digits in black immediately to right of the plot circle followed by the pressure tendency symbol.</p>
<p>PRESSURE SYSTEMS PRESSURE TENDENCY RISE THEN FALL LOWER</p> <p>Static/Dynamic: D Symbol Set Code: 45 Code: 110509</p> <p>Color: Black / Red (RGB 255,0,0)</p>		<p><u>Anchor Points:</u> This graphic requires one anchor point. The center point defines the geometric center of the graphic.</p> <p><u>Size/Shape:</u> Scalable.</p> <p><u>Orientation:</u> The graphic is centered over the anchor location.</p> <p>Note: Pressure tendency symbols are depicted to the right of the plot circle just after the text value for the actual pressure change. Pressure tendency is displayed in two digits in black immediately to right of the plot circle followed by the pressure tendency symbol.</p>
<p>TURBULENCE</p> <p>Static/Dynamic: N/A Symbol Set Code: 45 Code: 120000</p>	<p>N/A</p>	<p>Note: USAF turbulence forecasts are based on Category II type aircraft.</p>

TABLE I-I. Atmospheric icons - Continued.

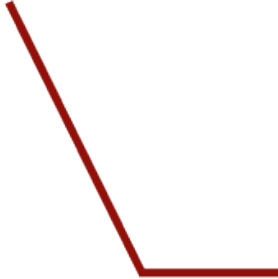

DESCRIPTION	ICON	DRAW RULES
<p>TURBULENCE LIGHT</p> <p>Static/Dynamic: D Symbol Set Code: 45 Code: 120100</p> <p>Color: Blue (RGB 0,0,255)</p>		<p><u>Anchor Points.</u> This graphic requires one anchor point. The center point defines the center of the graphic.</p> <p><u>Size/Shape.</u> Scalable.</p> <p><u>Orientation:</u> The graphic is oriented upright on the display and operator-centered over the desired location.</p> <p>Note: Intensity is dependent upon the associated aircraft type. The turbulence is indicated by the graphic and the height (X in 3 digits) above mean sea level in hundreds of feet (or meters) is included within the graphic.</p>
<p>TURBULENCE MODERATE</p> <p>Static/Dynamic: D Symbol Set Code: 45 Code: 120200</p> <p>Color: Blue (RGB 0,0,255)</p>		<p><u>Anchor Points.</u> This graphic requires one anchor point. The center point defines the center of the graphic.</p> <p><u>Size/Shape.</u> Scalable.</p> <p><u>Orientation:</u> The graphic is oriented upright on the display and operator-centered over the desired location.</p> <p>Note: Intensity is dependent upon the associated aircraft type. The turbulence is indicated by the graphic and the height (X in 3 digits) above mean sea level in hundreds of feet (or meters) is included within the graphic.</p>
<p>TURBULENCE SEVERE</p> <p>Static/Dynamic: D Symbol Set Code: 45 Code: 120300</p> <p>Color: Blue (RGB 0,0,255)</p>		<p><u>Anchor Points.</u> This graphic requires one anchor point. The center point defines the center of the graphic.</p> <p><u>Size/Shape.</u> Scalable.</p> <p><u>Orientation:</u> The graphic is oriented upright on the display and operator-centered over the desired location.</p> <p>Note: Intensity is dependent upon the associated aircraft type. The turbulence is indicated by the graphic and the height (X in 3 digits) above mean sea level in hundreds of feet (or meters) is included within the graphic.</p>

TABLE I-I. Atmospheric icons - Continued.

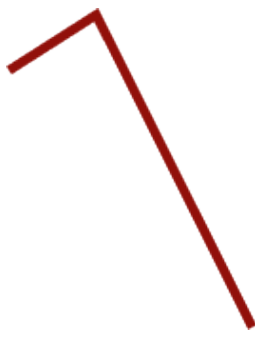

DESCRIPTION	ICON	DRAW RULES
<p>TURBULENCE EXTREME</p> <p>Static/Dynamic: D Symbol Set Code: 45 Code: 120400</p> <p>Color: Blue (RGB 0,0,255)</p>		<p><u>Anchor Points.</u> This graphic requires one anchor point. The center point defines the center of the graphic.</p> <p><u>Size/Shape.</u> Scalable.</p> <p><u>Orientation:</u> The graphic is oriented upright on the display and operator-centered over the desired location.</p> <p>Note: Intensity is dependent upon the associated aircraft type. The turbulence is indicated by the graphic and the height (X in 3 digits) above mean sea level in hundreds of feet (or meters) is included within the graphic.</p>
<p>TURBULENCE MOUNTAIN WAVES</p> <p>Static/Dynamic: D Symbol Set Code: 45 Code: 120500</p> <p>Color: Blue (RGB 0,0,255)</p>		<p><u>Anchor Points.</u> This graphic requires one anchor point. The center point defines the center of the graphic.</p> <p><u>Size/Shape.</u> Scalable.</p> <p><u>Orientation:</u> The graphic is oriented upright on the display and operator-centered over the desired location.</p> <p>Note: The turbulence is indicated by the graphic and the height (X in 3 digits) above mean sea level in hundreds of feet (or meters) is included within the graphic.</p>
<p>ICING</p> <p>Static/Dynamic: N/A Symbol Set Code: 45 Code: 130000</p>	<p>N/A</p>	<p>N/A</p>
<p>ICING CLEAR ICING</p> <p>Static/Dynamic: N/A Symbol Set Code: 45 Code: 130100</p>	<p>N/A</p>	<p>N/A</p>

TABLE I-I. Atmospheric icons - Continued.



DESCRIPTION	ICON	DRAW RULES
<p>ICING CLEAR ICING LIGHT</p> <p>Static/Dynamic: D Symbol Set Code: 45 Code: 130101</p> <p>Color: Brown (RGB 124,96,13)</p>		<p><u>Anchor Points.</u> This graphic requires one anchor point. The center point defines the center of the graphic.</p> <p><u>Size/Shape.</u> Scalable.</p> <p><u>Orientation:</u> The graphic is oriented upright on the display and operator-centered over the desired location.</p> <p>Note: The icing is indicated by the graphic and the height (X in 3 digits) above mean sea level in hundreds of feet (or meters) is included within the graphic.</p>
<p>ICING CLEAR ICING MODERATE</p> <p>Static/Dynamic: D Symbol Set Code: 45 Code: 130102</p> <p>Color: Brown (RGB 124,96,13)</p>		<p><u>Anchor Points.</u> This graphic requires one anchor point. The center point defines the center of the graphic.</p> <p><u>Size/Shape.</u> Scalable.</p> <p><u>Orientation:</u> The graphic is oriented upright on the display and operator-centered over the desired location.</p> <p>Note: The icing is indicated by the graphic and the height (X in 3 digits) above mean sea level in hundreds of feet (or meters) is included within the graphic.</p>
<p>ICING CLEAR ICING SEVERE</p> <p>Static/Dynamic: D Symbol Set Code: 45 Code: 130103</p> <p>Color: Brown (RGB 124,96,13)</p>		<p><u>Anchor Points.</u> This graphic requires one anchor point. The center point defines the center of the graphic.</p> <p><u>Size/Shape.</u> Scalable.</p> <p><u>Orientation:</u> The graphic is oriented upright on the display and operator-centered over the desired location.</p> <p>Note: The icing is indicated by the graphic and the height (X in 3 digits) above mean sea level in hundreds of feet (or meters) is included within the graphic.</p>

TABLE I-I. Atmospheric icons - Continued.



DESCRIPTION	ICON	DRAW RULES
<p>ICING RIME ICING</p> <p>Static/Dynamic: N/A Symbol Set Code: 45 Code: 130200</p>	<p>N/A</p>	<p>N/A</p>
<p>ICING RIME ICING LIGHT</p> <p>Static/Dynamic: D Symbol Set Code: 45 Code: 130201</p> <p>Color: Brown (RGB 124,96,13)</p>		<p><u>Anchor Points.</u> This graphic requires one anchor point. The center point defines the center of the graphic.</p> <p><u>Size/Shape.</u> Scalable.</p> <p><u>Orientation:</u> The graphic is oriented upright on the display and operator-centered over the desired location.</p> <p>Note: The icing is indicated by the graphic and the height (X in 3 digits) above mean sea level in hundreds of feet (or meters) is included within the graphic.</p>
<p>ICING RIME ICING MODERATE</p> <p>Static/Dynamic: D Symbol Set Code: 45 Code: 130202</p> <p>Color: Brown (RGB 124,96,13)</p>		<p><u>Anchor Points.</u> This graphic requires one anchor point. The center point defines the center of the graphic.</p> <p><u>Size/Shape.</u> Scalable.</p> <p><u>Orientation:</u> The graphic is oriented upright on the display and operator-centered over the desired location.</p> <p>Note: The icing is indicated by the graphic and the height (X in 3 digits) above mean sea level in hundreds of feet (or meters) is included within the graphic.</p>

TABLE I-I. Atmospheric icons - Continued.



DESCRIPTION	ICON	DRAW RULES
<p>ICING RIME ICING SEVERE</p> <p>Static/Dynamic: D Symbol Set Code: 45 Code: 130203</p> <p>Color: Brown (RGB 124,96,13)</p>		<p><u>Anchor Points.</u> This graphic requires one anchor point. The center point defines the center of the graphic.</p> <p><u>Size/Shape.</u> Scalable.</p> <p><u>Orientation:</u> The graphic is oriented upright on the display and operator-centered over the desired location.</p> <p>Note: The icing is indicated by the graphic and the height (X in 3 digits) above mean sea level in hundreds of feet (or meters) is included within the graphic.</p>
<p>ICING MIXED ICING</p> <p>Static/Dynamic: N/A Symbol Set Code: 45 Code: 130300</p>	<p>N/A</p>	
<p>ICING MIXED ICING LIGHT</p> <p>Static/Dynamic: D Symbol Set Code: 45 Code: 130301</p> <p>Color: Brown (RGB 124,96,13)</p>		<p><u>Anchor Points.</u> This graphic requires one anchor point. The center point defines the center of the graphic.</p> <p><u>Size/Shape.</u> Scalable.</p> <p><u>Orientation:</u> The graphic is oriented upright on the display and operator-centered over the desired location.</p> <p>Note: The icing is indicated by the graphic and the height (X in 3 digits) above mean sea level in hundreds of feet (or meters) is included within the graphic.</p>

TABLE I-I. Atmospheric icons - Continued.



DESCRIPTION	ICON	DRAW RULES
<p>ICING MIXED ICING MODERATE</p> <p>Static/Dynamic: D Symbol Set Code: 45 Code: 130302</p> <p>Color: Brown (RGB 124,96,13)</p>		<p><u>Anchor Points.</u> This graphic requires one anchor point. The center point defines the center of the graphic.</p> <p><u>Size/Shape.</u> Scalable.</p> <p><u>Orientation:</u> The graphic is oriented upright on the display and operator-centered over the desired location.</p> <p>Note: The icing is indicated by the graphic and the height (X in 3 digits) above mean sea level in hundreds of feet (or meters) is included within the graphic.</p>
<p>ICING MIXED ICING SEVERE</p> <p>Static/Dynamic: D Symbol Set Code: 45 Code: 130303</p> <p>Color: Brown (RGB 124,96,13)</p>		<p><u>Anchor Points.</u> This graphic requires one anchor point. The center point defines the center of the graphic.</p> <p><u>Size/Shape.</u> Scalable.</p> <p><u>Orientation:</u> The graphic is oriented upright on the display and operator-centered over the desired location.</p> <p>Note: The icing is indicated by the graphic and the height (X in 3 digits) above mean sea level in hundreds of feet (or meters) is included within the graphic.</p>
<p>WINDS</p> <p>Static/Dynamic: N/A Symbol Set Code: 45 Code: 140000</p>	<p>N/A</p>	
<p>WINDS CALM WINDS</p> <p>Static/Dynamic: D Symbol Set Code: 45 Code: 140100</p> <p>Color: Black</p>		<p><u>Anchor Points.</u> This graphic requires one anchor point. The center point defines the center of the graphic.</p> <p><u>Size/Shape.</u> Scalable.</p> <p><u>Orientation.</u> The graphic is centered over the location of the reported wind.</p>

TABLE I-I. Atmospheric icons - Continued.



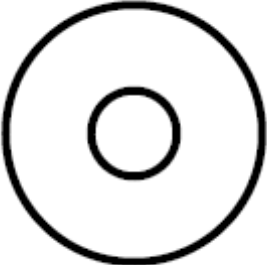

DESCRIPTION	ICON	DRAW RULES
<p>WINDS</p> <p>WIND PLOT</p> <p>Static/Dynamic: D Symbol Set Code: 45 Code: 140200</p> <p>Color: Black</p>	<p>Image 1</p> 	<p><u>Anchor Points.</u> This graphic requires a minimum of two anchor points. The first point defines the location of the plot circle. Additional points define the wind shaft and the speed of the wind. Wind speed is depicted on the shaft using a combination of the shaft alone (1-2 knots), half barbs (5 knots), barbs (10 knots) and pennants (50 knots). Wind speeds 5 knots or greater are rounded to the nearest 5 knots. Missing wind speed is depicted by an "X" at the end of the wind shaft. Winds with missing direction are not displayed.</p> <p><u>Size/Shape.</u> Not applicable.</p> <p><u>Orientation.</u> The shaft of the graphic is oriented with reference to true north in the direction from which the wind is blowing to the nearest 10 degrees. The barbs and pennants lie back from the shaft at an angle of 120 degrees and are oriented to the left of the shaft in the Northern Hemisphere and to the right in the Southern Hemisphere. The graphic is operator-centered over the desired location.</p> <p>Note: Cloud coverage is typically depicted in the plot circle in accordance with cloud coverage graphics. The wind speed, direction and cloud coverage depicted in wind plot graphics are example only.</p> <p><u>Image 1:</u> From 270 degrees at 1-2 knots</p> <p><u>Image 2:</u> From 270 degrees at 5 knots</p> <p><u>Image 3:</u> From 250 degrees at 10 knots</p> <p><u>Image 4:</u> From 110 degrees at 25 knots</p> <p><u>Image 5:</u> From 250 degrees at 50 knots</p>
	<p>Image 2</p> 	
	<p>Image 3</p> 	
	<p>Image 4</p> 	
	<p>Image 5</p> 	

TABLE I-I. Atmospheric icons - Continued.

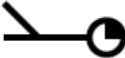

DESCRIPTION	ICON	DRAW RULES
	<p>Image 6</p> 	<p>Image 6: From 270 degrees with missing wind speed</p>
<p>WINDS JET STREAM</p> <p>Static/Dynamic: D Symbol Set Code: 45 Code: 140300</p> <p>Color: Red or Black</p>		<p><u>Anchor Points</u>. This graphic requires at least two anchor points, points 1 and 2, to define the line. Additional points can be defined to extend the line.</p> <p><u>Size/Shape</u>. Scalable/Curve.</p> <p><u>Orientation</u>. The first and last anchor points determine the length of the line. The arrowheads will be evenly spaced along the line.</p>
<p>WINDS STREAM LINE</p> <p>Static/Dynamic: D Symbol Set Code: 45 Code: 140400</p> <p>Color: Operator Defined</p>		<p><u>Anchor Points</u>. This graphic requires at least two anchor points, points 1 and 2, to define the line. Additional points can be defined to extend the line.</p> <p><u>Size/Shape</u>. Scalable/Curve.</p> <p><u>Orientation</u>. The first and last anchor points determine the length of the line. The arrowheads will be evenly spaced along the line.</p>
<p>CLOUD COVERAGE</p> <p>Static/Dynamic: N/A Symbol Set Code: 45 Code: 150000</p>	<p>N/A</p>	<p>N/A</p>
<p>CLOUD COVERAGE CLOUD COVERAGE SYMBOLS</p> <p>Static/Dynamic: N/A Symbol Set Code: 45 Code: 150100</p>	<p>N/A</p>	<p>N/A</p>

TABLE I-I. Atmospheric icons - Continued.

DESCRIPTION	ICON	DRAW RULES
<p>CLOUD COVERAGE CLOUD COVERAGE SYMBOLS CLEAR SKY</p> <p>Static/Dynamic: D Symbol Set Code: 45 Code: 150101</p> <p>Color: Black</p>		<p><u>Anchor Points.</u> This graphic requires one anchor point. The center point defines the center of the graphic.</p> <p><u>Size/Shape.</u> Scalable.</p> <p><u>Orientation.</u> The graphic is centered over the location of the reported cloud cover.</p>
<p>CLOUD COVERAGE CLOUD COVERAGE SYMBOLS FEW COVERAGE</p> <p>Static/Dynamic: D Symbol Set Code: 45 Code: 150102</p> <p>Color: Black</p>		<p><u>Anchor Points.</u> This graphic requires one anchor point. The center point defines the center of the graphic.</p> <p><u>Size/Shape.</u> Scalable.</p> <p><u>Orientation.</u> The graphic is centered over the location of the reported cloud cover.</p>
<p>CLOUD COVERAGE CLOUD COVERAGE SYMBOLS SCATTERED COVERAGE</p> <p>Static/Dynamic: D Symbol Set Code: 45 Code: 150103</p> <p>Color: Black</p>		<p><u>Anchor Points.</u> This graphic requires one anchor point. The center point defines the center of the graphic.</p> <p><u>Size/Shape.</u> Scalable.</p> <p><u>Orientation.</u> The graphic is centered over the location of the reported cloud cover.</p>
<p>CLOUD COVERAGE CLOUD COVERAGE SYMBOLS BROKEN COVERAGE</p> <p>Static/Dynamic: D Symbol Set Code: 45 Code: 150104</p> <p>Color: Black</p>		<p><u>Anchor Points.</u> This graphic requires one anchor point. The center point defines the center of the graphic.</p> <p><u>Size/Shape.</u> Scalable.</p> <p><u>Orientation.</u> The graphic is centered over the location of the reported cloud cover.</p>

TABLE I-I. Atmospheric icons - Continued.



DESCRIPTION	ICON	DRAW RULES
<p>CLOUD COVERAGE CLOUD COVERAGE SYMBOLS OVERCAST COVERAGE</p> <p>Static/Dynamic: D Symbol Set Code: 45 Code: 150105</p> <p>Color: Black</p>		<p><u>Anchor Points.</u> This graphic requires one anchor point. The center point defines the center of the graphic.</p> <p><u>Size/Shape.</u> Scalable.</p> <p><u>Orientation.</u> The graphic is centered over the location of the reported cloud cover.</p>
<p>CLOUD COVERAGE CLOUD COVERAGE SYMBOLS SKY TOTALLY OR PARTIALLY OBSCURED</p> <p>Static/Dynamic: D Symbol Set Code: 45 Code: 150106</p> <p>Color: Black</p>		<p><u>Anchor Points.</u> This graphic requires one anchor point. The center point defines the center of the graphic.</p> <p><u>Size/Shape.</u> Scalable.</p> <p><u>Orientation.</u> The graphic is centered over the location of the reported cloud cover.</p>
<p>WEATHER SYMBOLS</p> <p>Static/Dynamic: S Symbol Set Code: 45 Code: 160000</p>	<p>N/A</p>	
<p>WEATHER SYMBOLS RAIN</p> <p>Static/Dynamic: S Symbol Set Code: 45 Code: 160100</p>	<p>N/A</p>	
<p>WEATHER SYMBOLS RAIN INTERMITTENT LIGHT</p> <p>Static/Dynamic: S Symbol Set Code: 45 Code: 160101</p> <p>Color: Green</p>		<p><u>Anchor Points.</u> This graphic requires one anchor point. The center point defines the center of the graphic.</p> <p><u>Size/Shape.</u> Scalable.</p> <p><u>Orientation.</u> The graphic is centered over the location of the reported conditions.</p>

TABLE I-I. Atmospheric icons - Continued.

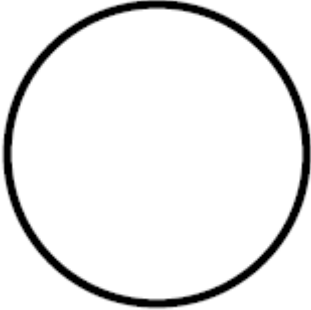
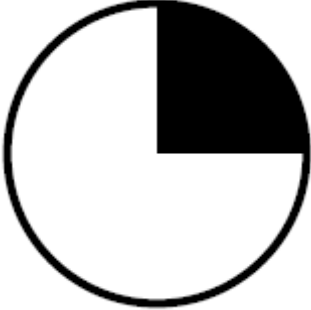
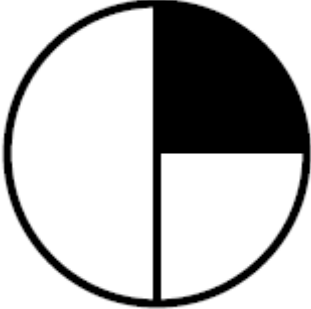
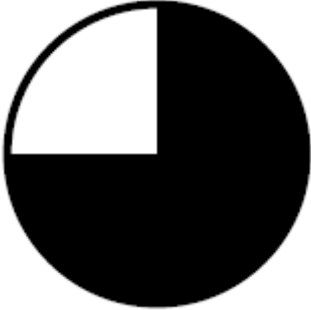

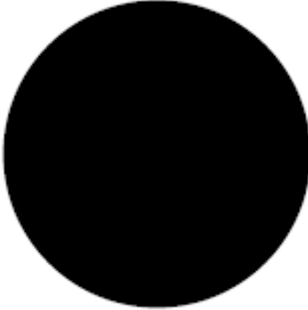
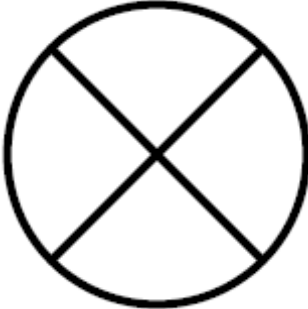

DESCRIPTION	ICON	DRAW RULES
<p>WEATHER SYMBOLS RAIN INTERMITTENT LIGHT CONTINUOUS LIGHT</p> <p>Static/Dynamic: S Symbol Set Code: 45 Code: 160102</p> <p>Color: Green</p>		<p><u>Anchor Points.</u> This graphic requires one anchor point. The center point defines the center of the graphic.</p> <p><u>Size/Shape.</u> Scalable.</p> <p><u>Orientation.</u> The graphic is centered over the location of the reported conditions.</p>
<p>WEATHER SYMBOLS RAIN INTERMITTENT MODERATE</p> <p>Static/Dynamic: S Symbol Set Code: 45 Code: 160103</p> <p>Color: Green</p>		<p><u>Anchor Points.</u> This graphic requires one anchor point. The center point defines the center of the graphic.</p> <p><u>Size/Shape.</u> Scalable.</p> <p><u>Orientation.</u> The graphic is centered over the location of the reported conditions.</p>
<p>WEATHER SYMBOLS RAIN INTERMITTENT MODERATE/CONTINUOUS MODERATE</p> <p>Static/Dynamic: S Symbol Set Code: 45 Code: 160104</p> <p>Color: Green</p>		<p><u>Anchor Points.</u> This graphic requires one anchor point. The center point defines the center of the graphic.</p> <p><u>Size/Shape.</u> Scalable.</p> <p><u>Orientation.</u> The graphic is centered over the location of the reported conditions.</p>
<p>WEATHER SYMBOLS RAIN INTERMITTENT HEAVY</p> <p>Static/Dynamic: S Symbol Set Code: 45 Code: 160105</p> <p>Color: Green</p>		<p><u>Anchor Points.</u> This graphic requires one anchor point. The center point defines the center of the graphic.</p> <p><u>Size/Shape.</u> Scalable.</p> <p><u>Orientation.</u> The graphic is centered over the location of the reported conditions.</p>

TABLE I-I. Atmospheric icons - Continued.



DESCRIPTION	ICON	DRAW RULES
<p>WEATHER SYMBOLS RAIN INTERMITTENT HEAVY/CONTINUOUS HEAVY</p> <p>Static/Dynamic: S Symbol Set Code: 45 Code: 160106</p> <p>Color: Green</p>		<p><u>Anchor Points.</u> This graphic requires one anchor point. The center point defines the center of the graphic.</p> <p><u>Size/Shape.</u> Scalable.</p> <p><u>Orientation.</u> The graphic is centered over the location of the reported conditions.</p>
<p>WEATHER SYMBOLS FREEZING RAIN</p> <p>Static/Dynamic: N/A Symbol Set Code: 45 Code: 160200</p>	<p>N/A</p>	
<p>WEATHER SYMBOLS FREEZING RAIN LIGHT</p> <p>Static/Dynamic: S Symbol Set Code: 45 Code: 160201</p> <p>Color: Red</p>		<p><u>Anchor Points.</u> This graphic requires one anchor point. The center point defines the center of the graphic.</p> <p><u>Size/Shape.</u> Scalable.</p> <p><u>Orientation.</u> The graphic is centered over the location of the reported conditions.</p>
<p>WEATHER SYMBOLS FREEZING RAIN MODERATE/HEAVY</p> <p>Static/Dynamic: S Symbol Set Code: 45 Code: 160202</p> <p>Color: Red</p>		<p><u>Anchor Points.</u> This graphic requires one anchor point. The center point defines the center of the graphic.</p> <p><u>Size/Shape.</u> Scalable.</p> <p><u>Orientation.</u> The graphic is centered over the location of the reported conditions.</p>
<p>WEATHER SYMBOLS RAIN SHOWERS</p> <p>Static/Dynamic: N/A Symbol Set Code: 45 Code: 160300</p>	<p>N/A</p>	

TABLE I-I. Atmospheric icons - Continued.





DESCRIPTION	ICON	DRAW RULES
<p>WEATHER SYMBOLS RAIN SHOWERS LIGHT</p> <p>Static/Dynamic: S Symbol Set Code: 45 Code: 160301</p> <p>Color: Green</p>		<p><u>Anchor Points.</u> This graphic requires one anchor point. The center point defines the center of the graphic.</p> <p><u>Size/Shape.</u> Scalable.</p> <p><u>Orientation.</u> The graphic is centered over the location of the reported conditions.</p>
<p>WEATHER SYMBOLS RAIN SHOWERS MODERATE/HEAVY</p> <p>Static/Dynamic: S Symbol Set Code: 45 Code: 160302</p> <p>Color: Green</p>		<p><u>Anchor Points.</u> This graphic requires one anchor point. The center point defines the center of the graphic.</p> <p><u>Size/Shape.</u> Scalable.</p> <p><u>Orientation.</u> The graphic is centered over the location of the reported conditions.</p>
<p>WEATHER SYMBOLS RAIN SHOWERS TORRENTIAL</p> <p>Static/Dynamic: S Symbol Set Code: 45 Code: 160303</p> <p>Color: Green</p>		<p><u>Anchor Points.</u> This graphic requires one anchor point. The center point defines the center of the graphic.</p> <p><u>Size/Shape.</u> Scalable.</p> <p><u>Orientation.</u> The graphic is centered over the location of the reported conditions.</p>
<p>WEATHER SYMBOLS DRIZZLE</p> <p>Static/Dynamic: N/A Symbol Set Code: 45 Code: 160400</p>	<p>N/A</p>	
<p>WEATHER SYMBOLS DRIZZLE INTERMITTENT LIGHT</p> <p>Static/Dynamic: S Symbol Set Code: 45 Code: 160401</p> <p>Color: Green</p>		<p><u>Anchor Points.</u> This graphic requires one anchor point. The center point defines the center of the graphic.</p> <p><u>Size/Shape.</u> Scalable.</p> <p><u>Orientation.</u> The graphic is centered over the location of the reported conditions.</p>

TABLE I-I. Atmospheric icons - Continued.





DESCRIPTION	ICON	DRAW RULES
<p>WEATHER SYMBOLS DRIZZLE INTERMITTENT LIGHT/CONTINUOUS LIGHT</p> <p>Static/Dynamic: S Symbol Set Code: 45 Code: 160402</p> <p>Color: Green</p>		<p><u>Anchor Points.</u> This graphic requires one anchor point. The center point defines the center of the graphic.</p> <p><u>Size/Shape.</u> Scalable.</p> <p><u>Orientation.</u> The graphic is centered over the location of the reported conditions.</p>
<p>WEATHER SYMBOLS DRIZZLE INTERMITTENT MODERATE</p> <p>Static/Dynamic: S Symbol Set Code: 45 Code: 160403</p> <p>Color: Green</p>		<p><u>Anchor Points.</u> This graphic requires one anchor point. The center point defines the center of the graphic.</p> <p><u>Size/Shape.</u> Scalable.</p> <p><u>Orientation.</u> The graphic is centered over the location of the reported conditions.</p>
<p>WEATHER SYMBOLS DRIZZLE INTERMITTENT MODERATE/CONTINUOUS MODERATE</p> <p>Static/Dynamic: S Symbol Set Code: 45 Code: 160404</p> <p>Color: Green</p>		<p><u>Anchor Points.</u> This graphic requires one anchor point. The center point defines the center of the graphic.</p> <p><u>Size/Shape.</u> Scalable.</p> <p><u>Orientation.</u> The graphic is centered over the location of the reported conditions.</p>
<p>WEATHER SYMBOLS DRIZZLE INTERMITTENT HEAVY</p> <p>Static/Dynamic: S Symbol Set Code: 45 Code: 160405</p> <p>Color: Green</p>		<p><u>Anchor Points.</u> This graphic requires one anchor point. The center point defines the center of the graphic.</p> <p><u>Size/Shape.</u> Scalable.</p> <p><u>Orientation.</u> The graphic is centered over the location of the reported conditions.</p>

TABLE I-I. Atmospheric icons - Continued.



DESCRIPTION	ICON	DRAW RULES
<p>WEATHER SYMBOLS DRIZZLE INTERMITTENT HEAVY/CONTINUOUS HEAVY</p> <p>Static/Dynamic: S Symbol Set Code: 45 Code: 160406</p> <p>Color: Green</p>		<p><u>Anchor Points.</u> This graphic requires one anchor point. The center point defines the center of the graphic.</p> <p><u>Size/Shape.</u> Scalable.</p> <p><u>Orientation.</u> The graphic is centered over the location of the reported conditions.</p>
<p>WEATHER SYMBOLS FREEZING DRIZZLE</p> <p>Static/Dynamic: N/A Symbol Set Code: 45 Code: 160500</p>	<p>N/A</p>	<p>N/A</p>
<p>WEATHER SYMBOLS FREEZING DRIZZLE LIGHT</p> <p>Static/Dynamic: S Symbol Set Code: 45 Code: 160501</p> <p>Color: Red</p>		<p><u>Anchor Points.</u> This graphic requires one anchor point. The center point defines the center of the graphic.</p> <p><u>Size/Shape.</u> Scalable.</p> <p><u>Orientation.</u> The graphic is centered over the location of the reported conditions.</p>
<p>WEATHER SYMBOLS FREEZING DRIZZLE MODERATE/HEAVY</p> <p>Static/Dynamic: S Symbol Set Code: 45 Code: 160502</p> <p>Color: Red</p>		<p><u>Anchor Points.</u> This graphic requires one anchor point. The center point defines the center of the graphic.</p> <p><u>Size/Shape.</u> Scalable.</p> <p><u>Orientation.</u> The graphic is centered over the location of the reported conditions.</p>
<p>WEATHER SYMBOLS RAIN AND SNOW MIXED</p> <p>Static/Dynamic: N/A Symbol Set Code: 45 Code: 160600</p>	<p>N/A</p>	

TABLE I-I. Atmospheric icons - Continued.





DESCRIPTION	ICON	DRAW RULES
<p>WEATHER SYMBOLS RAIN AND SNOW MIXED RAIN OR DRIZZLE AND SNOW - LIGHT</p> <p>Static/Dynamic: S Symbol Set Code: 45 Code: 160601</p> <p>Color: Green</p>		<p><u>Anchor Points.</u> This graphic requires one anchor point. The center point defines the center of the graphic.</p> <p><u>Size/Shape.</u> Scalable.</p> <p><u>Orientation.</u> The graphic is centered over the location of the reported conditions.</p>
<p>WEATHER SYMBOLS RAIN AND SNOW MIXED RAIN OR DRIZZLE AND SNOW - MODERATE/HEAVY</p> <p>Static/Dynamic: S Symbol Set Code: 45 Code: 160602</p> <p>Color: Green</p>		<p><u>Anchor Points.</u> This graphic requires one anchor point. The center point defines the center of the graphic.</p> <p><u>Size/Shape.</u> Scalable.</p> <p><u>Orientation.</u> The graphic is centered over the location of the reported conditions.</p>
<p>WEATHER SYMBOLS RAIN AND SNOW MIXED RAIN AND SNOW SHOWERS - LIGHT</p> <p>Static/Dynamic: S Symbol Set Code: 45 Code: 160603</p> <p>Color: Green</p>		<p><u>Anchor Points.</u> This graphic requires one anchor point. The center point defines the center of the graphic.</p> <p><u>Size/Shape.</u> Scalable.</p> <p><u>Orientation.</u> The graphic is centered over the location of the reported conditions.</p>
<p>WEATHER SYMBOLS RAIN AND SNOW MIXED RAIN AND SNOW SHOWERS - MODERATE/HEAVY</p> <p>Static/Dynamic: S Symbol Set Code: 45 Code: 160604</p> <p>Color: Green</p>		<p><u>Anchor Points.</u> This graphic requires one anchor point. The center point defines the center of the graphic.</p> <p><u>Size/Shape.</u> Scalable.</p> <p><u>Orientation.</u> The graphic is centered over the location of the reported conditions.</p>
<p>WEATHER SYMBOLS SNOW</p> <p>Static/Dynamic: N/A Symbol Set Code: 45 Code: 160700</p>	<p>N/A</p>	

TABLE I-I. Atmospheric icons - Continued.



DESCRIPTION	ICON	DRAW RULES
<p>WEATHER SYMBOLS SNOW INTERMITTENT LIGHT</p> <p>Static/Dynamic: S Symbol Set Code: 45 Code: 160701</p> <p>Color: Green</p>		<p><u>Anchor Points.</u> This graphic requires one anchor point. The center point defines the center of the graphic.</p> <p><u>Size/Shape.</u> Scalable.</p> <p><u>Orientation.</u> The graphic is centered over the location of the reported conditions.</p>
<p>WEATHER SYMBOLS SNOW INTERMITTENT LIGHT/CONTINUOUS LIGHT</p> <p>Static/Dynamic: S Symbol Set Code: 45 Code: 160702</p> <p>Color: Green</p>		<p><u>Anchor Points.</u> This graphic requires one anchor point. The center point defines the center of the graphic.</p> <p><u>Size/Shape.</u> Scalable.</p> <p><u>Orientation.</u> The graphic is centered over the location of the reported conditions.</p>
<p>WEATHER SYMBOLS SNOW INTERMITTENT MODERATE</p> <p>Static/Dynamic: S Symbol Set Code: 45 Code: 160703</p> <p>Color: Green</p>		<p><u>Anchor Points.</u> This graphic requires one anchor point. The center point defines the center of the graphic.</p> <p><u>Size/Shape.</u> Scalable.</p> <p><u>Orientation.</u> The graphic is centered over the location of the reported conditions.</p>
<p>WEATHER SYMBOLS SNOW INTERMITTENT MODERATE/CONTINUOUS MODERATE</p> <p>Static/Dynamic: S Symbol Set Code: 45 Code: 160704</p> <p>Color: Green</p>		<p><u>Anchor Points.</u> This graphic requires one anchor point. The center point defines the center of the graphic.</p> <p><u>Size/Shape.</u> Scalable.</p> <p><u>Orientation.</u> The graphic is centered over the location of the reported conditions.</p>

TABLE I-I. Atmospheric icons - Continued.



DESCRIPTION	ICON	DRAW RULES
<p>WEATHER SYMBOLS SNOW INTERMITTENT HEAVY</p> <p>Static/Dynamic: S Symbol Set Code: 45 Code: 160705</p> <p>Color: Green</p>		<p><u>Anchor Points.</u> This graphic requires one anchor point. The center point defines the center of the graphic.</p> <p><u>Size/Shape.</u> Scalable.</p> <p><u>Orientation.</u> The graphic is centered over the location of the reported conditions.</p>
<p>WEATHER SYMBOLS SNOW INTERMITTENT HEAVY/CONTINUOUS HEAVY</p> <p>Static/Dynamic: S Symbol Set Code: 45 Code: 160706</p> <p>Color: Green</p>		<p><u>Anchor Points.</u> This graphic requires one anchor point. The center point defines the center of the graphic.</p> <p><u>Size/Shape.</u> Scalable.</p> <p><u>Orientation.</u> The graphic is centered over the location of the reported conditions.</p>
<p>WEATHER SYMBOLS SNOW BLOWING SNOW - LIGHT/MODERATE</p> <p>Static/Dynamic: S Symbol Set Code: 45 Code: 160707</p> <p>Color: Green</p>		<p><u>Anchor Points.</u> This graphic requires one anchor point. The center point defines the center of the graphic.</p> <p><u>Size/Shape.</u> Scalable.</p> <p><u>Orientation.</u> The graphic is centered over the location of the reported conditions.</p>
<p>WEATHER SYMBOLS SNOW BLOWING SNOW - HEAVY</p> <p>Static/Dynamic: S Symbol Set Code: 45 Code: 160708</p> <p>Color: Green</p>		<p><u>Anchor Points.</u> This graphic requires one anchor point. The center point defines the center of the graphic.</p> <p><u>Size/Shape.</u> Scalable.</p> <p><u>Orientation.</u> The graphic is centered over the location of the reported conditions.</p>

TABLE I-I. Atmospheric icons - Continued.

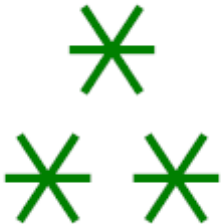

DESCRIPTION	ICON	DRAW RULES
<p>WEATHER SYMBOLS SNOW GRAINS</p> <p>Static/Dynamic: S Symbol Set Code: 45 Code: 160800</p> <p>Color: Green</p>		<p><u>Anchor Points.</u> This graphic requires one anchor point. The center point defines the center of the graphic.</p> <p><u>Size/Shape.</u> Scalable.</p> <p><u>Orientation.</u> The graphic is centered over the location of the reported conditions.</p>
<p>WEATHER SYMBOLS SNOW SHOWERS</p> <p>Static/Dynamic: N/A Symbol Set Code: 45 Code: 160900</p>	<p>N/A</p>	<p>N/A</p>
<p>WEATHER SYMBOLS SNOW SHOWERS LIGHT</p> <p>Static/Dynamic: S Symbol Set Code: 45 Code: 160901</p> <p>Color: Green</p>		<p><u>Anchor Points.</u> This graphic requires one anchor point. The center point defines the center of the graphic.</p> <p><u>Size/Shape.</u> Scalable.</p> <p><u>Orientation.</u> The graphic is centered over the location of the reported conditions.</p>
<p>WEATHER SYMBOLS SNOW SHOWERS MODERATE/HEAVY</p> <p>Static/Dynamic: S Symbol Set Code: 45 Code: 160902</p> <p>Color: Green</p>		<p><u>Anchor Points.</u> This graphic requires one anchor point. The center point defines the center of the graphic.</p> <p><u>Size/Shape.</u> Scalable.</p> <p><u>Orientation.</u> The graphic is centered over the location of the reported conditions.</p>
<p>WEATHER SYMBOLS HAIL</p> <p>Static/Dynamic: N/A Symbol Set Code: 45 Code: 161000</p>	<p>N/A</p>	<p>N/A</p>

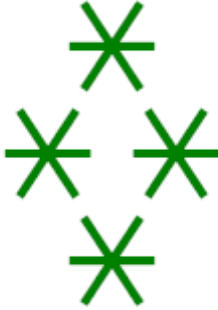
TABLE I-I. Atmospheric icons - Continued.





DESCRIPTION	ICON	DRAW RULES
<p>WEATHER SYMBOLS HAIL LIGHT NOT ASSOCIATED WITH THUNDER</p> <p>Static/Dynamic: S Symbol Set Code: 45 Code: 161001</p> <p>Color: Red</p>		<p><u>Anchor Points</u>. This graphic requires one anchor point. The center point defines the center of the graphic.</p> <p><u>Size/Shape</u>. Scalable.</p> <p><u>Orientation</u>. The graphic is centered over the location of the reported conditions.</p>
<p>WEATHER SYMBOLS HAIL MODERATE/HEAVY NOT ASSOCIATED WITH THUNDER</p> <p>Static/Dynamic: S Symbol Set Code: 45 Code: 161002</p> <p>Color: Red</p>		<p><u>Anchor Points</u>. This graphic requires one anchor point. The center point defines the center of the graphic.</p> <p><u>Size/Shape</u>. Scalable.</p> <p><u>Orientation</u>. The graphic is centered over the location of the reported conditions.</p>
<p>WEATHER SYMBOLS ICE CRYSTALS (DIAMOND DUST)</p> <p>Static/Dynamic: S Symbol Set Code: 45 Code: 161100</p> <p>Color: Red</p>		<p><u>Anchor Points</u>. This graphic requires one anchor point. The center point defines the center of the graphic.</p> <p><u>Size/Shape</u>. Scalable.</p> <p><u>Orientation</u>. The graphic is centered over the location of the reported conditions.</p>
<p>WEATHER SYMBOLS ICE PELLETS (SLEET)</p> <p>Static/Dynamic: N/A Symbol Set Code: 45 Code: 161200</p>	<p>N/A</p>	<p>N/A</p>
<p>WEATHER SYMBOLS ICE PELLETS (SLEET) LIGHT</p> <p>Static/Dynamic: S Symbol Set Code: 45 Code: 161201</p> <p>Color: Red</p>		<p><u>Anchor Points</u>. This graphic requires one anchor point. The center point defines the center of the graphic.</p> <p><u>Size/Shape</u>. Scalable.</p> <p><u>Orientation</u>. The graphic is centered over the location of the reported conditions.</p>

TABLE I-I. Atmospheric icons - Continued.





DESCRIPTION	ICON	DRAW RULES
<p>WEATHER SYMBOLS ICE PELLETS (SLEET) MODERATE</p> <p>Static/Dynamic: S Symbol Set Code: 45 Code: 161202</p> <p>Color: Red</p>		<p><u>Anchor Points.</u> This graphic requires one anchor point. The center point defines the center of the graphic.</p> <p><u>Size/Shape.</u> Scalable.</p> <p><u>Orientation.</u> The graphic is centered over the location of the reported conditions.</p>
<p>WEATHER SYMBOLS ICE PELLETS (SLEET) HEAVY</p> <p>Static/Dynamic: S Symbol Set Code: 45 Code: 161203</p> <p>Color: Red</p>		<p><u>Anchor Points.</u> This graphic requires one anchor point. The center point defines the center of the graphic.</p> <p><u>Size/Shape.</u> Scalable.</p> <p><u>Orientation.</u> The graphic is centered over the location of the reported conditions.</p>
<p>WEATHER SYMBOLS INVERSION</p> <p>Static/Dynamic: N/A Symbol Set Code: 45 Code: 161300</p>		<p><u>Anchor Points.</u> This graphic requires one anchor point. The center point defines the center of the graphic.</p> <p><u>Size/Shape.</u> Scalable.</p> <p><u>Orientation.</u> The graphic is centered over the location of the reported conditions.</p>
<p>WEATHER SYMBOLS STORMS</p> <p>Static/Dynamic: N/A Symbol Set Code: 45 Code: 161400</p>	<p>N/A</p>	
<p>WEATHER SYMBOLS STORMS THUNDERSTORM - NO PRECIPITATION</p> <p>Static/Dynamic: S Symbol Set Code: 45 Code: 161401</p> <p>Color: Red</p>		<p><u>Anchor Points.</u> This graphic requires one anchor point. The center point defines the center of the graphic.</p> <p><u>Size/Shape.</u> Scalable.</p> <p><u>Orientation.</u> The graphic is centered over the location of the reported conditions.</p>

TABLE I-I. Atmospheric icons - Continued.



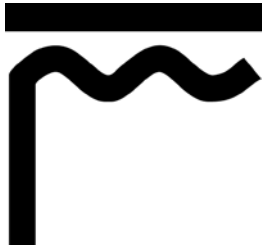

DESCRIPTION	ICON	DRAW RULES
<p>WEATHER SYMBOLS STORMS THUNDERSTORM LIGHT TO MODERATE WITH RAIN/SNOW - NO HAIL</p> <p>Static/Dynamic: S Symbol Set Code: 45 Code: 161402</p> <p>Color: Red</p>		<p><u>Anchor Points.</u> This graphic requires one anchor point. The center point defines the center of the graphic.</p> <p><u>Size/Shape.</u> Scalable.</p> <p><u>Orientation.</u> The graphic is centered over the location of the reported conditions.</p>
<p>WEATHER SYMBOLS STORMS THUNDERSTORM HEAVY WITH RAIN/SNOW - NO HAIL</p> <p>Static/Dynamic: S Symbol Set Code: 45 Code: 161403</p> <p>Color: Red</p>		<p><u>Anchor Points.</u> This graphic requires one anchor point. The center point defines the center of the graphic.</p> <p><u>Size/Shape.</u> Scalable.</p> <p><u>Orientation.</u> The graphic is centered over the location of the reported conditions.</p>
<p>WEATHER SYMBOLS STORMS THUNDERSTORM LIGHT TO MODERATE - WITH HAIL</p> <p>Static/Dynamic: S Symbol Set Code: 45 Code: 161404</p> <p>Color: Red</p>		<p><u>Anchor Points.</u> This graphic requires one anchor point. The center point defines the center of the graphic.</p> <p><u>Size/Shape.</u> Scalable.</p> <p><u>Orientation.</u> The graphic is centered over the location of the reported conditions.</p>
<p>WEATHER SYMBOLS STORMS THUNDERSTORM HEAVY - WITH HAIL</p> <p>Static/Dynamic: S Symbol Set Code: 45 Code: 161405</p> <p>Color: Red</p>		<p><u>Anchor Points.</u> This graphic requires one anchor point. The center point defines the center of the graphic.</p> <p><u>Size/Shape.</u> Scalable.</p> <p><u>Orientation.</u> The graphic is centered over the location of the reported conditions.</p>

TABLE I-I. Atmospheric icons - Continued.





DESCRIPTION	ICON	DRAW RULES
<p>WEATHER SYMBOLS STORMS FUNNEL CLOUD (TORNADO/WATERSPOUT)</p> <p>Static/Dynamic: S Symbol Set Code: 45 Code: 161406</p> <p>Color: Red</p>		<p><u>Anchor Points.</u> This graphic requires one anchor point. The center point defines the center of the graphic.</p> <p><u>Size/Shape.</u> Scalable.</p> <p><u>Orientation.</u> The graphic is centered over the location of the reported conditions.</p>
<p>WEATHER SYMBOLS STORMS SQUALL</p> <p>Static/Dynamic: S Symbol Set Code: 45 Code: 161407</p> <p>Color: Red</p>		<p><u>Anchor Points.</u> This graphic requires one anchor point. The center point defines the center of the graphic.</p> <p><u>Size/Shape.</u> Scalable.</p> <p><u>Orientation.</u> The graphic is centered over the location of the reported conditions.</p>
<p>WEATHER SYMBOLS STORMS LIGHTNING</p> <p>Static/Dynamic: S Symbol Set Code: 45 Code: 161408</p> <p>Color: Red</p>		<p><u>Anchor Points.</u> This graphic requires one anchor point. The center point defines the center of the graphic.</p> <p><u>Size/Shape.</u> Scalable.</p> <p><u>Orientation.</u> The graphic is centered over the location of the reported conditions.</p>
<p>WEATHER SYMBOLS FOG</p> <p>Static/Dynamic: N/A Symbol Set Code: 45 Code: 161500</p>	<p>N/A</p>	<p>N/A</p>
<p>WEATHER SYMBOLS FOG SHALLOW PATCHES</p> <p>Static/Dynamic: S Symbol Set Code: 45 Code: 161501</p> <p>Color: Yellow</p>		<p><u>Anchor Points.</u> This graphic requires one anchor point. The center point defines the center of the graphic.</p> <p><u>Size/Shape.</u> Scalable.</p> <p><u>Orientation.</u> The graphic is centered over the location of the reported conditions.</p>

TABLE I-I. Atmospheric icons - Continued.



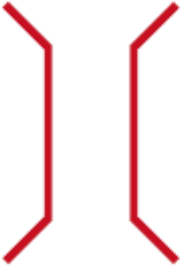

DESCRIPTION	ICON	DRAW RULES
<p>WEATHER SYMBOLS FOG SHALLOW CONTINUOUS</p> <p>Static/Dynamic: S Symbol Set Code: 45 Code: 161502</p> <p>Color: Yellow</p>		<p><u>Anchor Points</u>. This graphic requires one anchor point. The center point defines the center of the graphic.</p> <p><u>Size/Shape</u>. Scalable.</p> <p><u>Orientation</u>. The graphic is centered over the location of the reported conditions.</p>
<p>WEATHER SYMBOLS FOG PATCHY</p> <p>Static/Dynamic: S Symbol Set Code: 45 Code: 161503</p> <p>Color: Yellow</p>		<p><u>Anchor Points</u>. This graphic requires one anchor point. The center point defines the center of the graphic.</p> <p><u>Size/Shape</u>. Scalable.</p> <p><u>Orientation</u>. The graphic is centered over the location of the reported conditions.</p>
<p>WEATHER SYMBOLS FOG SKY VISIBLE</p> <p>Static/Dynamic: S Symbol Set Code: 45 Code: 161504</p> <p>Color: Yellow</p>		<p><u>Anchor Points</u>. This graphic requires one anchor point. The center point defines the center of the graphic.</p> <p><u>Size/Shape</u>. Scalable.</p> <p><u>Orientation</u>. The graphic is centered over the location of the reported conditions.</p>
<p>WEATHER SYMBOLS FOG SKY OBSCURED</p> <p>Static/Dynamic: S Symbol Set Code: 45 Code: 161505</p> <p>Color: Yellow</p>		<p><u>Anchor Points</u>. This graphic requires one anchor point. The center point defines the center of the graphic.</p> <p><u>Size/Shape</u>. Scalable.</p> <p><u>Orientation</u>. The graphic is centered over the location of the reported conditions.</p>

TABLE I-I. Atmospheric icons - Continued.



DESCRIPTION	ICON	DRAW RULES
<p>WEATHER SYMBOLS FOG FREEZING, SKY VISIBLE</p> <p>Static/Dynamic: S Symbol Set Code: 45 Code: 161506</p> <p>Color: Red</p>		<p><u>Anchor Points.</u> This graphic requires one anchor point. The center point defines the center of the graphic.</p> <p><u>Size/Shape.</u> Scalable.</p> <p><u>Orientation.</u> The graphic is centered over the location of the reported conditions.</p>
<p>WEATHER SYMBOLS FOG FREEZING, SKY NOT VISIBLE</p> <p>Static/Dynamic: S Symbol Set Code: 45 Code: 161507</p> <p>Color: Red</p>		<p><u>Anchor Points.</u> This graphic requires one anchor point. The center point defines the center of the graphic.</p> <p><u>Size/Shape.</u> Scalable.</p> <p><u>Orientation.</u> The graphic is centered over the location of the reported conditions.</p>
<p>WEATHER SYMBOLS MIST</p> <p>Static/Dynamic: S Symbol Set Code: 45 Code: 161600</p> <p>Color: Yellow</p>		<p><u>Anchor Points.</u> This graphic requires one anchor point. The center point defines the center of the graphic.</p> <p><u>Size/Shape.</u> Scalable.</p> <p><u>Orientation.</u> The graphic is centered over the location of the reported conditions.</p>
<p>WEATHER SYMBOLS SMOKE</p> <p>Static/Dynamic: S Symbol Set Code: 45 Code: 161700</p> <p>Color: Brown</p>		<p><u>Anchor Points.</u> This graphic requires one anchor point. The center point defines the center of the graphic.</p> <p><u>Size/Shape.</u> Scalable.</p> <p><u>Orientation.</u> The graphic is centered over the location of the reported conditions.</p>

TABLE I-I. Atmospheric icons - Continued.



DESCRIPTION	ICON	DRAW RULES
<p>WEATHER SYMBOLS HAZE</p> <p>Static/Dynamic: S Symbol Set Code: 45 Code: 161800</p> <p>Color: Brown</p>		<p><u>Anchor Points.</u> This graphic requires one anchor point. The center point defines the center of the graphic.</p> <p><u>Size/Shape.</u> Scalable.</p> <p><u>Orientation.</u> The graphic is centered over the location of the reported conditions.</p>
<p>WEATHER SYMBOLS DUST OR SAND</p> <p>Static/Dynamic: N/A Symbol Set Code: 45 Code: 161900</p>	<p>N/A</p>	<p>N/A</p>
<p>WEATHER SYMBOLS DUST OR SAND LIGHT TO MODERATE</p> <p>Static/Dynamic: S Symbol Set Code: 45 Code: 161901</p> <p>Color: Brown</p>		<p><u>Anchor Points.</u> This graphic requires one anchor point. The center point defines the center of the graphic.</p> <p><u>Size/Shape.</u> Scalable.</p> <p><u>Orientation.</u> The graphic is centered over the location of the reported conditions.</p>
<p>WEATHER SYMBOLS DUST OR SAND SEVERE</p> <p>Static/Dynamic: S Symbol Set Code: 45 Code: 161902</p> <p>Color: Brown</p>		<p><u>Anchor Points.</u> This graphic requires one anchor point. The center point defines the center of the graphic.</p> <p><u>Size/Shape.</u> Scalable.</p> <p><u>Orientation.</u> The graphic is centered over the location of the reported conditions.</p>

TABLE I-I. Atmospheric icons - Continued.

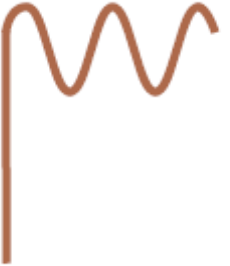

DESCRIPTION	ICON	DRAW RULES
<p>WEATHER SYMBOLS DUST OR SAND DUST DEVIL</p> <p>Static/Dynamic: S Symbol Set Code: 45 Code: 161903</p> <p>Color: Brown</p>		<p><u>Anchor Points.</u> This graphic requires one anchor point. The center point defines the center of the graphic.</p> <p><u>Size/Shape.</u> Scalable.</p> <p><u>Orientation.</u> The graphic is centered over the location of the reported conditions.</p>
<p>WEATHER SYMBOLS DUST OR SAND BLOWING DUST OR SAND</p> <p>Static/Dynamic: S Symbol Set Code: 45 Code: 161904</p> <p>Color: Brown</p>		<p><u>Anchor Points.</u> This graphic requires one anchor point. The center point defines the center of the graphic.</p> <p><u>Size/Shape.</u> Scalable.</p> <p><u>Orientation.</u> The graphic is centered over the location of the reported conditions.</p>
<p>WEATHER SYMBOLS TROPICAL STORM SYSTEMS</p> <p>Static/Dynamic: N/A Symbol Set Code: 45 Code: 162000</p>	<p>N/A</p>	<p>N/A</p>
<p>WEATHER SYMBOLS TROPICAL STORM SYSTEMS TROPICAL DEPRESSION</p> <p>Static/Dynamic: D Symbol Set Code: 45 Code: 162001</p> <p>Color: Red, Purple or Black</p> <p><i>Red or Purple</i> - Current and Forecast Position <i>Black</i> - Past Position</p>		<p><u>Anchor Points.</u> This graphic requires one anchor point. The center point defines the center of the graphic.</p> <p><u>Size/Shape.</u> Scalable.</p> <p><u>Orientation.</u> The graphic is centered over the position of the tropical system.</p>

TABLE I-I. Atmospheric icons - Continued.



DESCRIPTION	ICON	DRAW RULES
<p>WEATHER SYMBOLS TROPICAL STORM SYSTEMS TROPICAL STORM</p> <p>Static/Dynamic: D Symbol Set Code: 45 Code: 162002</p> <p>Color: Red, Purple or Black</p> <p><i>Red or Purple</i> - Current and Forecast Position <i>Black</i> - Past Position</p>		<p><u>Anchor Points.</u> This graphic requires one anchor point. The center point defines the center of the graphic.</p> <p><u>Size/Shape.</u> Scalable.</p> <p><u>Orientation.</u> The graphic is centered over the position of the tropical system.</p>
<p>WEATHER SYMBOLS TROPICAL STORM SYSTEMS HURRICANE/TYPHOON</p> <p>Static/Dynamic: D Symbol Set Code: 45 Code: 162003</p> <p>Color: Red, Purple or Black</p> <p><i>Red or Purple</i> - Current and Forecast Position <i>Black</i> - Past Position</p>		<p><u>Anchor Points.</u> This graphic requires one anchor point. The center point defines the center of the graphic.</p> <p><u>Size/Shape.</u> Scalable.</p> <p><u>Orientation.</u> The graphic is centered over the position of the tropical system.</p>
<p>WEATHER SYMBOLS TROPICAL STORM SYSTEMS TROPICAL STORM WIND AREAS AND DATE/TIME LABELS</p> <p>Static/Dynamic: D Symbol Set Code: 45 Code: 162004</p> <p>Color: Red/Purple/Black</p> <p><i>Red</i> - Outermost area of winds = 34 knots <i>Purple</i> - Second area of winds = 50 knots [=64 knots Atlantic only] <i>Red or Black</i> - Innermost area of winds = 100 knots</p> <p>Note: US Navy ship avoidance areas can be depicted using Operator-Defined Freeform.</p>		<p><u>Anchor Points.</u> This graphic requires at least three anchor points to define the boundary of the area. Add as many points as necessary to accurately reflect the area's size and shape.</p> <p><u>Size/Shape.</u> Scalable.</p> <p><u>Orientation.</u> Not applicable.</p>

TABLE I-I. Atmospheric icons - Continued.



DESCRIPTION	ICON	DRAW RULES
<p>WEATHER SYMBOLS VOLCANIC ERUPTION</p> <p>Static/Dynamic: S Symbol Set Code: 45 Code: 162100</p> <p>Color: Black</p>		<p><u>Anchor Points.</u> This graphic requires one anchor point. The center point defines the center of the graphic.</p> <p><u>Size/Shape.</u> Scalable.</p> <p><u>Orientation.</u> The graphic is centered over the location of the reported conditions.</p>
<p>WEATHER SYMBOLS VOLCANIC ERUPTION VOLCANIC ASH</p> <p>Static/Dynamic: S Symbol Set Code: 45 Code: 162101</p> <p>Color: Black or Brown</p>		<p><u>Anchor Points.</u> This graphic requires one anchor point. The center point defines the center of the graphic.</p> <p><u>Size/Shape.</u> Scalable.</p> <p><u>Orientation.</u> The graphic is centered over the location of the reported conditions.</p>
<p>WEATHER SYMBOLS TROPOPAUSE LEVEL</p> <p>Static/Dynamic: D Symbol Set Code: 45 Code: 162200</p> <p>Color: Black</p>		<p><u>Anchor Points.</u> This graphic requires one anchor point. The center point defines the center of the graphic.</p> <p><u>Size/Shape.</u> Scalable.</p> <p><u>Orientation.</u> The graphic is centered over the location of the reported conditions.</p>
<p>WEATHER SYMBOLS FREEZING LEVEL</p> <p>Static/Dynamic: D Symbol Set Code: 45 Code: 162300</p> <p>Color: Black</p>		<p><u>Anchor Points.</u> This graphic requires one anchor point. The center point defines the center of the graphic.</p> <p><u>Size/Shape.</u> Scalable.</p> <p><u>Orientation.</u> The graphic is centered over the location of the reported conditions.</p>

TABLE I-I. Atmospheric icons - Continued.

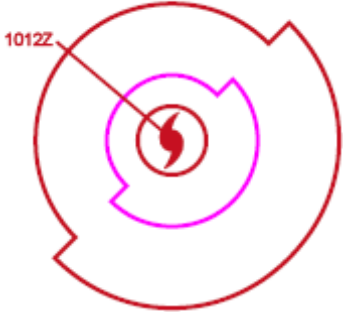

DESCRIPTION	ICON	DRAW RULES
<p>WEATHER SYMBOLS PRECIPITATION OF UNKNOWN TYPE AND INTENSITY</p> <p>Static/Dynamic: S Symbol Set Code: 45 Code: 162400</p> <p>Color: Green</p>		<p><u>Anchor Points.</u> This graphic requires one anchor point. The center point defines the center of the graphic.</p> <p><u>Size/Shape.</u> Scalable.</p> <p><u>Orientation.</u> The graphic is centered over the location of the reported conditions.</p>
<p>BOUNDED AREAS OF WEATHER</p> <p>Static/Dynamic: N/A Symbol Set Code: 45 Code: 170000</p>	<p>N/A</p>	
<p>BOUNDED AREAS OF WEATHER INSTRUMENT FLIGHT RULE (IFR)</p> <p>Static/Dynamic: S Symbol Set Code: 45 Code: 170100</p> <p>Color: Red</p>		<p><u>Anchor Points.</u> This graphic requires at least three anchor points to define the boundary of the area. Add as many points as necessary to accurately reflect the area's size and shape.</p> <p><u>Size/Shape.</u> Determined by the anchor points.</p> <p><u>Orientation.</u> Not applicable.</p>
<p>BOUNDED AREAS OF WEATHER MARGINAL VISUAL FLIGHT RULE (MVFR)</p> <p>Static/Dynamic: S Symbol Set Code: 45 Code: 170200</p> <p>Color: Blue</p>		<p><u>Anchor Points.</u> This graphic requires at least three anchor points to define the boundary of the area. Add as many points as necessary to accurately reflect the area's size and shape.</p> <p><u>Size/Shape.</u> Determined by the anchor points.</p> <p><u>Orientation.</u> Not applicable.</p>
<p>BOUNDED AREAS OF WEATHER TURBULENCE</p> <p>Static/Dynamic: S Symbol Set Code: 45 Code: 170300</p> <p>Color: Blue</p>		<p><u>Anchor Points.</u> This graphic requires at least three anchor points to define the boundary of the area. Add as many points as necessary to accurately reflect the area's size and shape.</p> <p><u>Size/Shape.</u> Determined by the anchor points.</p> <p><u>Orientation.</u> Not applicable.</p>

TABLE I-I. Atmospheric icons - Continued.

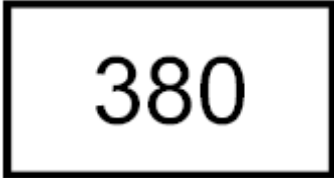
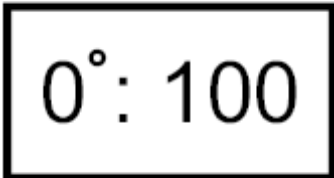

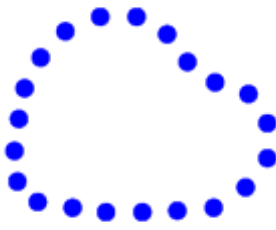

DESCRIPTION	ICON	DRAW RULES
<p>BOUNDED AREAS OF WEATHER ICING</p> <p>Static/Dynamic: S Symbol Set Code: 45 Code: 170400</p> <p>Color: Brown</p>		<p><u>Anchor Points.</u> This graphic requires at least three anchor points to define the boundary of the area. Add as many points as necessary to accurately reflect the area's size and shape.</p> <p><u>Size/Shape.</u> Determined by the anchor points.</p> <p><u>Orientation.</u> Not applicable.</p>
<p>BOUNDED AREAS OF WEATHER LIQUID PRECIPITATION - NON-CONVECTIVE CONTINUOUS OR INTERMITTENT</p> <p>Static/Dynamic: S Symbol Set Code: 45 Code: 170500</p> <p>Color: Green</p>		<p><u>Anchor Points.</u> This graphic requires at least three anchor points to define the boundary of the area. Add as many points as necessary to accurately reflect the area's size and shape.</p> <p><u>Size/Shape.</u> Determined by the anchor points.</p> <p><u>Orientation.</u> Not applicable.</p>
<p>BOUNDED AREAS OF WEATHER LIQUID PRECIPITATION - NON-CONVECTIVE CONTINUOUS OR INTERMITTENT LIQUID PRECIPITATION – CONVECTIVE</p> <p>Static/Dynamic: S Symbol Set Code: 45 Code: 170501</p> <p>Color: Green</p>		<p><u>Anchor Points.</u> This graphic requires at least three anchor points to define the boundary of the area. Add as many points as necessary to accurately reflect the area's size and shape.</p> <p><u>Size/Shape.</u> Determined by the anchor points.</p> <p><u>Orientation.</u> Not applicable.</p>
<p>BOUNDED AREAS OF WEATHER FREEZING/FROZEN PRECIPITATION</p> <p>Static/Dynamic: S Symbol Set Code: 45 Code: 170600</p> <p>Color: Red</p>		<p><u>Anchor Points.</u> This graphic requires at least three anchor points to define the boundary of the area. Add as many points as necessary to accurately reflect the area's size and shape.</p> <p><u>Size/Shape.</u> Determined by the anchor points.</p> <p><u>Orientation.</u> Not applicable.</p>

TABLE I-I. Atmospheric icons - Continued.



DESCRIPTION	ICON	DRAW RULES
<p>BOUNDED AREAS OF WEATHER THUNDERSTORMS</p> <p>Static/Dynamic: S Symbol Set Code: 45 Code: 170700</p> <p>Color: Red</p>		<p><u>Anchor Points.</u> This graphic requires at least three anchor points to define the boundary of the area. Add as many points as necessary to accurately reflect the area's size and shape.</p> <p><u>Size/Shape.</u> Determined by the anchor points.</p> <p><u>Orientation.</u> Not applicable.</p>
<p>BOUNDED AREAS OF WEATHER FOG</p> <p>Static/Dynamic: S Symbol Set Code: 45 Code: 170800</p> <p>Color: Yellow</p>		<p><u>Anchor Points.</u> This graphic requires at least three anchor points to define the boundary of the area. Add as many points as necessary to accurately reflect the area's size and shape.</p> <p><u>Size/Shape.</u> Determined by the anchor points.</p> <p><u>Orientation.</u> Not applicable.</p>
<p>BOUNDED AREAS OF WEATHER DUST OR SAND</p> <p>Static/Dynamic: S Symbol Set Code: 45 Code: 170900</p> <p>Color: Brown</p>		<p><u>Anchor Points.</u> This graphic requires at least three anchor points to define the boundary of the area. Add as many points as necessary to accurately reflect the area's size and shape.</p> <p><u>Size/Shape.</u> Determined by the anchor points.</p> <p><u>Orientation.</u> Not applicable.</p>

TABLE I-I. Atmospheric icons - Continued.

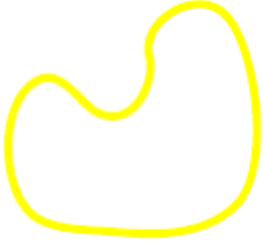

DESCRIPTION	ICON	DRAW RULES
<p>BOUNDED AREAS OF WEATHER OPERATOR-DEFINED FREEFORM</p> <p>Static/Dynamic: S Symbol Set Code: 45 Code: 171000</p> <p>Color: Operator Defined</p>		<p>(Used to designate areas of specific weather phenomenon as determined by the operator.)</p> <p><u>Anchor Points</u>. This graphic requires at least three anchor points to define the boundary of the area. Add as many points as necessary to accurately reflect the area's size and shape.</p> <p><u>Size/Shape</u>. Determined by the anchor points.</p> <p><u>Orientation</u>. Not applicable.</p>
<p>ISOPLETHS</p> <p>Static/Dynamic: N/A Symbol Set Code: 45 Code: 180000</p>	<p>N/A</p>	<p>N/A</p>
<p>ISOPLETHS ISOBAR – SURFACE</p> <p>Static/Dynamic: D Symbol Set Code: 45 Code: 180100</p> <p>Color: Black</p>		<p><u>Anchor Points</u>. This graphic requires at least two anchor points, points 1 and 2, to define the line. Additional points can be defined to extend the line.</p> <p><u>Size/Shape</u>. Scalable/Curve.</p> <p><u>Orientation</u>. The first and last anchor points determine the length of the line. The modifier text will be placed at each end of the line and once in the middle of the line.</p> <p>Note: Used on surface analyses. Although not part of the graphic, numerical values of the isopleth can be placed along the line for presentation.</p>

TABLE I-I. Atmospheric icons - Continued.

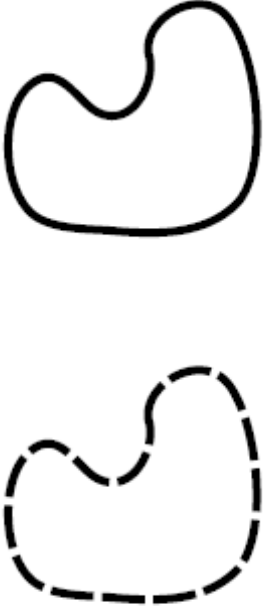

DESCRIPTION	ICON	DRAW RULES
<p>ISOPLETHS CONTOUR - UPPER AIR</p> <p>Static/Dynamic: D Symbol Set Code: 45 Code: 180200</p> <p>Color: Black</p>		<p><u>Anchor Points.</u> This graphic requires at least two anchor points, points 1 and 2, to define the line. Additional points can be defined to extend the line.</p> <p><u>Size/Shape.</u> Scalable/Curve.</p> <p><u>Orientation.</u> The first and last anchor points determine the length of the line. The modifier text will be placed at each end of the line and once in the middle of the line.</p> <p>Note: Used on upper air analyses. Although not part of the graphic, numerical values of the isopleth can be placed along the line for presentation.</p>
<p>ISOPLETHS ISOTHERM</p> <p>Static/Dynamic: D Symbol Set Code: 45 Code: 180300</p> <p>Color: Red</p>		<p><u>Anchor Points.</u> This graphic requires at least two anchor points, points 1 and 2, to define the line. Additional points can be defined to extend the line.</p> <p><u>Size/Shape.</u> Scalable/Curve.</p> <p><u>Orientation.</u> The first and last anchor points determine the length of the line. The modifier text will be placed at each end of the line and once in the middle of the line.</p>
<p>ISOPLETHS ISOTACH</p> <p>Static/Dynamic: D Symbol Set Code: 45 Code: 180400</p> <p>Color: Purple</p>		<p><u>Anchor Points.</u> This graphic requires at least two anchor points, points 1 and 2, to define the line. Additional points can be defined to extend the line.</p> <p><u>Size/Shape.</u> Scalable/Curve.</p> <p><u>Orientation.</u> The first and last anchor points determine the length of the line. The modifier text will be placed at each end of the line and once in the middle of the line.</p>

TABLE I-I. Atmospheric icons - Continued.



DESCRIPTION	ICON	DRAW RULES
<p>ISOPLETHS ISODROSOTHERM</p> <p>Static/Dynamic: D Symbol Set Code: 45 Code: 180500</p> <p>Color: Green</p>		<p><u>Anchor Points.</u> This graphic requires at least two anchor points, points 1 and 2, to define the line. Additional points can be defined to extend the line.</p> <p><u>Size/Shape.</u> Scalable/Curve.</p> <p><u>Orientation.</u> The first and last anchor points determine the length of the line. The modifier text will be placed at each end of the line and once in the middle of the line.</p>
<p>ISOPLETHS THICKNESS</p> <p>Static/Dynamic: D Symbol Set Code: 45 Code: 180600</p> <p>Color: Red</p>		<p><u>Anchor Points.</u> This graphic requires at least two anchor points, points 1 and 2, to define the line. Additional points can be defined to extend the line.</p> <p><u>Size/Shape.</u> Scalable/Curve.</p> <p><u>Orientation.</u> The first and last anchor points determine the length of the line. The modifier text will be placed at each end of the line and once in the middle of the line.</p>
<p>ISOPLETHS OPERATOR-DEFINED FREEFORM</p> <p>Static/Dynamic: D Symbol Set Code: 45 Code: 180700</p> <p>Color: Operator Defined</p>		<p>(Used to display isopleth areas of specific weather parameters as determined by the operator.)</p> <p><u>Anchor Points.</u> This graphic requires at least two anchor points, points 1 and 2, to define the line. Additional points can be defined to extend the line.</p> <p><u>Size/Shape.</u> Scalable/Curve.</p> <p><u>Orientation.</u> The first and last anchor points determine the length of the line. The modifier text will be placed at each end of the line and once in the middle of the line.</p>
<p>STATE OF THE GROUND</p> <p>Static/Dynamic: N/A Symbol Set Code: 45 Code: 190000</p>	<p>N/A</p>	<p>N/A</p>

TABLE I-I. Atmospheric icons - Continued.



DESCRIPTION	ICON	DRAW RULES
<p>STATE OF THE GROUND WITHOUT SNOW OR MEASURABLE ICE COVER</p> <p>Static/Dynamic: N/A Symbol Set Code: 45 Code: 190100</p>	<p>N/A</p>	<p>N/A</p>
<p>STATE OF THE GROUND WITHOUT SNOW OR MEASURABLE ICE COVER SURFACE DRY WITHOUT CRACKS OR APPRECIABLE DUST OR LOOSE SAND</p> <p>Static/Dynamic: S Symbol Set Code: 45 Code: 190101</p> <p>Color: Black</p>		<p><u>Anchor Points.</u> This graphic requires one anchor point. The center point defines the center of the graphic.</p> <p><u>Size/Shape.</u> Scalable.</p> <p><u>Orientation.</u> The graphic is typically centered over the desired location.</p>
<p>STATE OF THE GROUND WITHOUT SNOW OR MEASURABLE ICE COVER SURFACE MOIST</p> <p>Static/Dynamic: S Symbol Set Code: 45 Code: 190102</p> <p>Color: Black</p>		<p><u>Anchor Points.</u> This graphic requires one anchor point. The center point defines the center of the graphic.</p> <p><u>Size/Shape.</u> Scalable.</p> <p><u>Orientation.</u> The graphic is typically centered over the desired location.</p>
<p>STATE OF THE GROUND WITHOUT SNOW OR MEASURABLE ICE COVER SURFACE WET, STANDING WATER IN SMALL OR LARGE POOLS</p> <p>Static/Dynamic: S Symbol Set Code: 45 Code: 190103</p> <p>Color: Black</p>		<p><u>Anchor Points.</u> This graphic requires one anchor point. The center point defines the center of the graphic.</p> <p><u>Size/Shape.</u> Scalable.</p> <p><u>Orientation.</u> The graphic is typically centered over the desired location.</p>

TABLE I-I. Atmospheric icons - Continued.

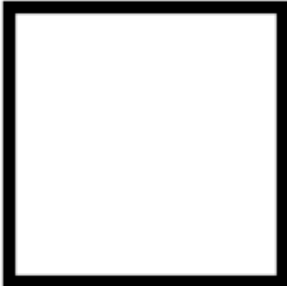
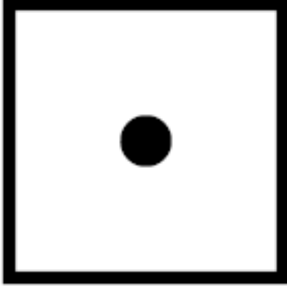

DESCRIPTION	ICON	DRAW RULES
<p>STATE OF THE GROUND WITHOUT SNOW OR MEASURABLE ICE COVER SURFACE FLOODED</p> <p>Static/Dynamic: S Symbol Set Code: 45 Code: 190104</p> <p>Color: Black</p>		<p><u>Anchor Points.</u> This graphic requires one anchor point. The center point defines the center of the graphic.</p> <p><u>Size/Shape.</u> Scalable.</p> <p><u>Orientation.</u> The graphic is typically centered over the desired location.</p>
<p>STATE OF THE GROUND WITHOUT SNOW OR MEASURABLE ICE COVER SURFACE FROZEN</p> <p>Static/Dynamic: S Symbol Set Code: 45 Code: 190105</p> <p>Color: Black</p>		<p><u>Anchor Points.</u> This graphic requires one anchor point. The center point defines the center of the graphic.</p> <p><u>Size/Shape.</u> Scalable.</p> <p><u>Orientation.</u> The graphic is typically centered over the desired location.</p>
<p>STATE OF THE GROUND WITHOUT SNOW OR MEASURABLE ICE COVER GLAZE (THIN ICE) ON GROUND</p> <p>Static/Dynamic: S Symbol Set Code: 45 Code: 190106</p> <p>Color: Black</p>		<p><u>Anchor Points.</u> This graphic requires one anchor point. The center point defines the center of the graphic.</p> <p><u>Size/Shape.</u> Scalable.</p> <p><u>Orientation.</u> The graphic is typically centered over the desired location.</p>
<p>STATE OF THE GROUND WITHOUT SNOW OR MEASURABLE ICE COVER LOOSE DRY DUST OR SAND NOT COVERING GROUND COMPLETELY</p> <p>Static/Dynamic: S Symbol Set Code: 45 Code: 190107</p> <p>Color: Black</p>		<p><u>Anchor Points.</u> This graphic requires one anchor point. The center point defines the center of the graphic.</p> <p><u>Size/Shape.</u> Scalable.</p> <p><u>Orientation.</u> The graphic is typically centered over the desired location.</p>

TABLE I-I. Atmospheric icons - Continued.

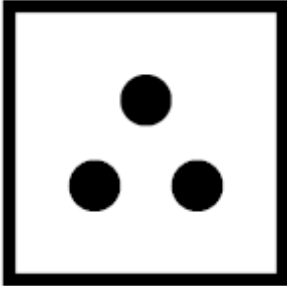
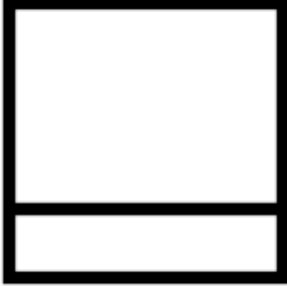
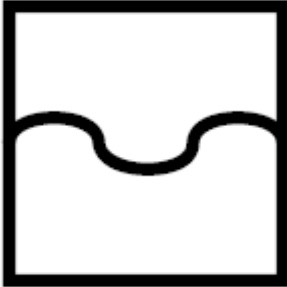

DESCRIPTION	ICON	DRAW RULES
<p>STATE OF THE GROUND WITHOUT SNOW OR MEASURABLE ICE COVER THIN LOOSE DRY DUST OR SAND COVERING GROUND COMPLETELY</p> <p>Static/Dynamic: S Symbol Set Code: 45 Code: 190108</p> <p>Color: Black</p>		<p><u>Anchor Points.</u> This graphic requires one anchor point. The center point defines the center of the graphic.</p> <p><u>Size/Shape.</u> Scalable.</p> <p><u>Orientation.</u> The graphic is typically centered over the desired location.</p>
<p>STATE OF THE GROUND WITHOUT SNOW OR MEASURABLE ICE COVER MODERATE/THICK LOOSE DRY DUST OR SAND COVERING GROUND COMPLETELY</p> <p>Static/Dynamic: S Symbol Set Code: 45 Code: 190109</p> <p>Color: Black</p>		<p><u>Anchor Points.</u> This graphic requires one anchor point. The center point defines the center of the graphic.</p> <p><u>Size/Shape.</u> Scalable.</p> <p><u>Orientation.</u> The graphic is typically centered over the desired location.</p>
<p>STATE OF THE GROUND WITHOUT SNOW OR MEASURABLE ICE COVER EXTREMELY DRY WITH CRACKS</p> <p>Static/Dynamic: S Symbol Set Code: 45 Code: 190110</p> <p>Color: Black</p>		<p><u>Anchor Points.</u> This graphic requires one anchor point. The center point defines the center of the graphic.</p> <p><u>Size/Shape.</u> Scalable.</p> <p><u>Orientation.</u> The graphic is typically centered over the desired location.</p>
<p>STATE OF THE GROUND WITH SNOW OR MEASURABLE ICE COVER</p> <p>Static/Dynamic: N/A Symbol Set Code: 45 Code: 190200</p>	<p>N/A</p>	

TABLE I-I. Atmospheric icons - Continued.



DESCRIPTION	ICON	DRAW RULES
<p>STATE OF THE GROUND WITH SNOW OR MEASURABLE ICE COVER PREDOMINATELY ICE COVERED</p> <p>Static/Dynamic: S Symbol Set Code: 45 Code: 190201</p> <p>Color: Black</p>		<p><u>Anchor Points.</u> This graphic requires one anchor point. The center point defines the center of the graphic.</p> <p><u>Size/Shape.</u> Scalable.</p> <p><u>Orientation.</u> The graphic is typically centered over the desired location.</p>
<p>STATE OF THE GROUND WITH SNOW OR MEASURABLE ICE COVER COMPACT OR WET SNOW (WITH OR WITHOUT ICE) COVERING LESS THAN ONE- HALF OF GROUND</p> <p>Static/Dynamic: S Symbol Set Code: 45 Code: 190202</p> <p>Color: Black</p>		<p><u>Anchor Points.</u> This graphic requires one anchor point. The center point defines the center of the graphic.</p> <p><u>Size/Shape.</u> Scalable.</p> <p><u>Orientation.</u> The graphic is typically centered over the desired location.</p>
<p>STATE OF THE GROUND WITH SNOW OR MEASURABLE ICE COVER COMPACT OR WET SNOW (WITH OR WITHOUT ICE) COVERING AT LEAST ONE-HALF GROUND, BUT GROUND NOT COMPLETELY COVERED</p> <p>Static/Dynamic: S Symbol Set Code: 45 Code: 190203</p> <p>Color: Black</p>		<p><u>Anchor Points.</u> This graphic requires one anchor point. The center point defines the center of the graphic.</p> <p><u>Size/Shape.</u> Scalable.</p> <p><u>Orientation.</u> The graphic is typically centered over the desired location.</p>
<p>STATE OF THE GROUND WITH SNOW OR MEASURABLE ICE COVER EVEN LAYER OF COMPACT OR WET SNOW COVERING GROUND COMPLETELY</p> <p>Static/Dynamic: S Symbol Set Code: 45 Code: 190204</p> <p>Color: Black</p>		<p><u>Anchor Points.</u> This graphic requires one anchor point. The center point defines the center of the graphic.</p> <p><u>Size/Shape.</u> Scalable.</p> <p><u>Orientation.</u> The graphic is typically centered over the desired location.</p>

TABLE I-I. Atmospheric icons - Continued.

DESCRIPTION	ICON	DRAW RULES
<p>STATE OF THE GROUND WITH SNOW OR MEASURABLE ICE COVER UNEVEN LAYER OF COMPACT OR WET SNOW COVERING GROUND COMPLETELY</p> <p>Static/Dynamic: S Symbol Set Code: 45 Code: 190205</p> <p>Color: Black</p>		<p><u>Anchor Points.</u> This graphic requires one anchor point. The center point defines the center of the graphic.</p> <p><u>Size/Shape.</u> Scalable.</p> <p><u>Orientation.</u> The graphic is typically centered over the desired location.</p>
<p>STATE OF THE GROUND WITH SNOW OR MEASURABLE ICE COVER LOOSE DRY SNOW COVERING LESS THAN ONE-HALF OF GROUND</p> <p>Static/Dynamic: S Symbol Set Code: 45 Code: 190206</p> <p>Color: Black</p>		<p><u>Anchor Points.</u> This graphic requires one anchor point. The center point defines the center of the graphic.</p> <p><u>Size/Shape.</u> Scalable.</p> <p><u>Orientation.</u> The graphic is typically centered over the desired location.</p>
<p>STATE OF THE GROUND WITH SNOW OR MEASURABLE ICE COVER LOOSE DRY SNOW COVERING AT LEAST ONE-HALF GROUND, BUT GROUND NOT COMPLETELY COVERED</p> <p>Static/Dynamic: S Symbol Set Code: 45 Code: 190207</p> <p>Color: Black</p>		<p><u>Anchor Points.</u> This graphic requires one anchor point. The center point defines the center of the graphic.</p> <p><u>Size/Shape.</u> Scalable.</p> <p><u>Orientation.</u> The graphic is typically centered over the desired location.</p>
<p>STATE OF THE GROUND WITH SNOW OR MEASURABLE ICE COVER EVEN LAYER OF LOOSE DRY SNOW COVERING GROUND COMPLETELY</p> <p>Static/Dynamic: S Symbol Set Code: 45 Code: 190208</p> <p>Color: Black</p>		<p><u>Anchor Points.</u> This graphic requires one anchor point. The center point defines the center of the graphic.</p> <p><u>Size/Shape.</u> Scalable.</p> <p><u>Orientation.</u> The graphic is typically centered over the desired location.</p>

TABLE I-I. Atmospheric icons - Continued.

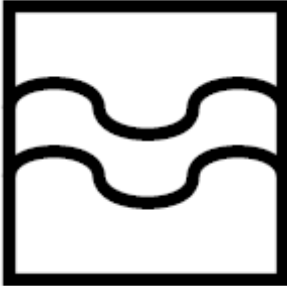
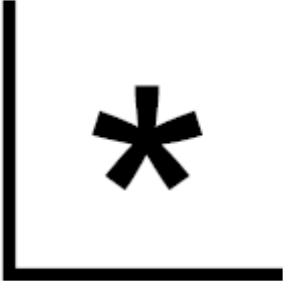

DESCRIPTION	ICON	DRAW RULES
<p>STATE OF THE GROUND WITH SNOW OR MEASURABLE ICE COVER UNEVEN LAYER OF LOOSE DRY SNOW COVERING GROUND COMPLETELY</p> <p>Static/Dynamic: S Symbol Set Code: 45 Code: 190209</p> <p>Color: Black</p>		<p><u>Anchor Points.</u> This graphic requires one anchor point. The center point defines the center of the graphic.</p> <p><u>Size/Shape.</u> Scalable.</p> <p><u>Orientation.</u> The graphic is typically centered over the desired location.</p>
<p>STATE OF THE GROUND WITH SNOW OR MEASURABLE ICE COVER SNOW COVERING GROUND COMPLETELY, DEEP DRIFTS</p> <p>Static/Dynamic: S Symbol Set Code: 45 Code: 190210</p> <p>Color: Black</p>		<p><u>Anchor Points.</u> This graphic requires one anchor point. The center point defines the center of the graphic.</p> <p><u>Size/Shape.</u> Scalable.</p> <p><u>Orientation.</u> The graphic is typically centered over the desired location.</p>

TABLE I-II. Oceanographic icons.

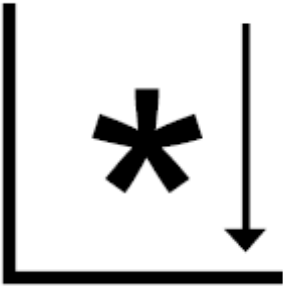
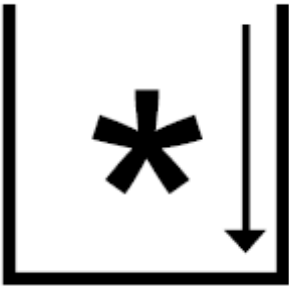
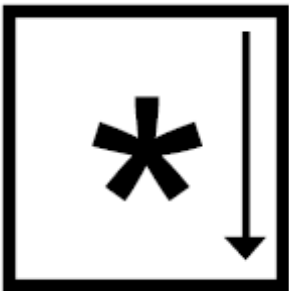
DESCRIPTION	ICON	DRAW RULES
<p>ICE SYSTEMS</p> <p>Static/Dynamic: N/A Symbol Set Code: 46 Code: 110000</p>	<p>N/A</p>	<p>N/A</p>
<p>ICE SYSTEMS ICEBERGS</p> <p>Static/Dynamic: S Symbol Set Code: 46 Code: 110100</p> <p>Color: Black</p>	<p>N/A</p>	<p>N/A</p>

TABLE I-II. Oceanographic icons - Continued.





DESCRIPTION	ICON	DRAW RULES
<p>ICE SYSTEMS ICEBERGS MANY ICEBERGS</p> <p>Static/Dynamic: S Symbol Set Code: 46 Code: 110101</p> <p>Color: Black</p>		<p><u>Anchor Points:</u> This graphic requires one anchor point. The center point defines the center of the graphic.</p> <p><u>Size/Shape:</u> Scalable.</p> <p><u>Orientation:</u> The graphic is oriented upright on the display and operator-centered over the desired location.</p>
<p>ICE SYSTEMS ICEBERGS BELTS AND STRIPS</p> <p>Static/Dynamic: S Symbol Set Code: 46 Code: 110102</p> <p>Color: Black</p>		<p><u>Anchor Points:</u> This graphic requires one anchor point. The center point defines the center of the graphic.</p> <p><u>Size/Shape:</u> Scalable.</p> <p><u>Orientation:</u> The graphic is oriented upright on the display and operator-centered over the desired location.</p>
<p>ICE SYSTEMS ICEBERGS GENERAL</p> <p>Static/Dynamic: S Symbol Set Code: 46 Code: 110103</p> <p>Color: Black</p>		<p><u>Anchor Points:</u> This graphic requires one anchor point. The center point defines the center of the graphic.</p> <p><u>Size/Shape:</u> Scalable.</p> <p><u>Orientation:</u> The graphic is typically centered over the desired location.</p>
<p>ICE SYSTEMS ICEBERGS MANY ICEBERGS – GENERAL</p> <p>Static/Dynamic: S Symbol Set Code: 46 Code: 110104</p> <p>Color: Black</p>		<p><u>Anchor Points:</u> This graphic requires one anchor point. The center point defines the center of the graphic.</p> <p><u>Size/Shape:</u> Scalable.</p> <p><u>Orientation:</u> The graphic is typically centered over the desired location.</p>

TABLE I-II. Oceanographic icons - Continued.





DESCRIPTION	ICON	DRAW RULES
<p>ICE SYSTEMS ICEBERGS BERGY BIT</p> <p>Static/Dynamic: S Symbol Set Code: 46 Code: 110105</p> <p>Color: Black</p>		<p><u>Anchor Points.</u> This graphic requires one anchor point. The center point defines the center of the graphic.</p> <p><u>Size/Shape.</u> Scalable.</p> <p><u>Orientation.</u> The graphic is oriented upright on the display as shown in the example and is operator-centered over the desired location.</p>
<p>ICE SYSTEMS ICEBERGS MANY BERGY BITS</p> <p>Static/Dynamic: S Symbol Set Code: 46 Code: 110106</p> <p>Color: Black</p>		<p><u>Anchor Points.</u> This graphic requires one anchor point. The center point defines the center of the graphic.</p> <p><u>Size/Shape.</u> Scalable.</p> <p><u>Orientation.</u> The graphic is oriented upright on the display as shown in the example and is operator-centered over the desired location.</p>
<p>ICE SYSTEMS ICEBERGS GROWLER</p> <p>Static/Dynamic: S Symbol Set Code: 46 Code: 110107</p> <p>Color: Black</p>		<p><u>Anchor Points.</u> This graphic requires one anchor point. The center point defines the center of the graphic.</p> <p><u>Size/Shape.</u> Scalable.</p> <p><u>Orientation.</u> The graphic is oriented upright on the display as shown in the example and is operator-centered over the desired location.</p>
<p>ICE SYSTEMS ICEBERGS MANY GROWLERS</p> <p>Static/Dynamic: S Symbol Set Code: 46 Code: 110108</p> <p>Color: Black</p>		<p><u>Anchor Points.</u> This graphic requires one anchor point. The center point defines the center of the graphic.</p> <p><u>Size/Shape.</u> Scalable.</p> <p><u>Orientation.</u> The graphic is oriented upright on the display as shown in the example and is operator-centered over the desired location.</p>

TABLE I-II. Oceanographic icons - Continued.

DESCRIPTION	ICON	DRAW RULES
<p>ICE SYSTEMS ICEBERGS FLOEBERG</p> <p>Static/Dynamic: S Symbol Set Code: 46 Code: 110109</p> <p>Color: Black Top with White Bottom</p>		<p><u>Anchor Points.</u> This graphic requires one anchor point. The center point defines the center of the graphic.</p> <p><u>Size/Shape.</u> Scalable.</p> <p><u>Orientation.</u> The graphic is oriented upright on the display as shown in the example and is operator-centered over the desired location.</p>
<p>ICE SYSTEMS ICEBERGS ICE ISLAND</p> <p>Static/Dynamic: S Symbol Set Code: 46 Code: 110110</p> <p>Color: White Hexagon/Black Hatches</p>		<p><u>Anchor Points.</u> This graphic requires one anchor point. The center point defines the center of the graphic.</p> <p><u>Size/Shape.</u> Scalable.</p> <p><u>Orientation.</u> The graphic is oriented upright on the display as shown in the example and is operator-centered over the desired location.</p>
<p>ICE SYSTEMS ICE CONCENTRATION</p> <p>Static/Dynamic: N/A Symbol Set Code: 46 Code: 110200</p> <p>Color: Black</p>	<p>N/A</p>	
<p>ICE SYSTEMS ICE CONCENTRATION BERGY WATER</p> <p>Static/Dynamic: S Symbol Set Code: 46 Code: 110201</p> <p>Color: Black</p>		<p><u>Anchor Points.</u> This graphic requires one anchor point. The center point defines the center of the graphic.</p> <p><u>Size/Shape.</u> Scalable.</p> <p><u>Orientation.</u> The graphic is oriented upright on the display as shown in the example and is operator-centered over the desired location.</p>

TABLE I-II. Oceanographic icons - Continued.



DESCRIPTION	ICON	DRAW RULES
<p>ICE SYSTEMS ICE CONCENTRATION WATER WITH RADAR TARGETS</p> <p>Static/Dynamic: S Symbol Set Code: 46 Code: 110202</p> <p>Color: Black</p>		<p><u>Anchor Points.</u> This graphic requires one anchor point. The center point defines the center of the graphic.</p> <p><u>Size/Shape.</u> Scalable.</p> <p><u>Orientation.</u> The graphic is oriented upright on the display as shown in the example and is operator-centered over the desired location.</p>
<p>ICE SYSTEMS ICE CONCENTRATION ICE FREE</p> <p>Static/Dynamic: S Symbol Set Code: 46 Code: 110203</p> <p>Color: Black</p>		<p><u>Anchor Points.</u> This graphic requires one anchor point. The center point defines the center of the graphic.</p> <p><u>Size/Shape.</u> Scalable.</p> <p><u>Orientation.</u> The graphic is oriented upright on the display as shown in the example and is operator-centered over the desired location.</p>
<p>ICE SYSTEMS DYNAMIC PROCESSES</p> <p>Static/Dynamic: N/A Symbol Set Code: 46 Code: 110300</p>	<p>N/A</p>	
<p>ICE SYSTEMS DYNAMIC PROCESSES CONVERGENCE</p> <p>Static/Dynamic: D Symbol Set Code: 46 Code: 110301</p> <p>Color: Black</p>		<p><u>Anchor Points.</u> This graphic requires one anchor point. The center point defines the center of the graphic.</p> <p><u>Size/Shape.</u> Scalable.</p> <p><u>Orientation.</u> The graphic is oriented upright on the display as shown in the example and is operator-centered over the desired location.</p>

TABLE I-II. Oceanographic icons - Continued.

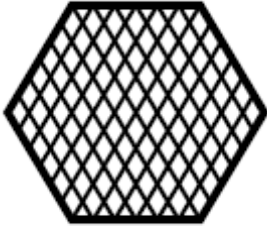
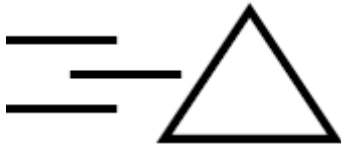

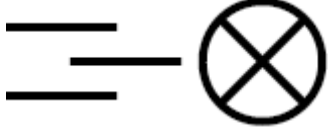
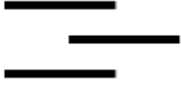

DESCRIPTION	ICON	DRAW RULES
<p>ICE SYSTEMS DYNAMIC PROCESSES DIVERGENCE</p> <p>Static/Dynamic: D Symbol Set Code: 46 Code: 110302</p> <p>Color: Black</p>		<p><u>Anchor Points.</u> This graphic requires one anchor point. The center point defines the center of the graphic.</p> <p><u>Size/Shape.</u> Scalable.</p> <p><u>Orientation.</u> The graphic is oriented upright on the display as shown in the example and is operator-centered over the desired location.</p>
<p>ICE SYSTEMS DYNAMIC PROCESSES SHEARING OR SHEAR ZONE</p> <p>Static/Dynamic: D Symbol Set Code: 46 Code: 110303</p> <p>Color: Black</p>		<p><u>Anchor Points.</u> This graphic requires one anchor point. The center point defines the center of the graphic.</p> <p><u>Size/Shape.</u> Scalable.</p> <p><u>Orientation.</u> The graphic is oriented upright on the display as shown in the example and is operator-centered over the desired location.</p>
<p>ICE SYSTEMS DYNAMIC PROCESSES ICE DRIFT (DIRECTION)</p> <p>Static/Dynamic: D Symbol Set Code: 46 Code: 110304</p> <p>Color: Black</p>		<p><u>Anchor Points.</u> This graphic requires one anchor point. The center point defines the center of the graphic.</p> <p><u>Size/Shape.</u> Scalable.</p> <p><u>Orientation.</u> The graphic is oriented upright on the display as shown in the example and is operator-centered over the desired location.</p>
<p>ICE SYSTEMS SEA ICE</p> <p>Static/Dynamic: D Symbol Set Code: 46 Code: 110400</p> <p>Color: Black</p>		<p><u>Anchor Points.</u> This graphic requires one anchor point. The center point defines the center of the graphic.</p> <p><u>Size/Shape.</u> Scalable.</p> <p><u>Orientation.</u> The graphic is operator-centered over the desired location.</p>

TABLE I-II. Oceanographic icons - Continued.



DESCRIPTION	ICON	DRAW RULES
<p>ICE SYSTEMS SEA ICE ICE THICKNESS (OBSERVED)</p> <p>Static/Dynamic: D Symbol Set Code: 46 Code: 110401</p> <p>Color: Box with Black Outline</p>		<p><u>Anchor Points.</u> This graphic requires one anchor point. The center point defines the center of the graphic.</p> <p><u>Size/Shape.</u> Scalable.</p> <p><u>Orientation.</u> The graphic is oriented upright on the display as shown in the example and is operator-centered over the desired location.</p>
<p>ICE SYSTEMS SEA ICE ICE THICKNESS (ESTIMATED)</p> <p>Static/Dynamic: D Symbol Set Code: 46 Code: 110402</p> <p>Color: Box with Black Dashed Line</p>		<p><u>Anchor Points.</u> This graphic requires one anchor point. The center point defines the center of the graphic.</p> <p><u>Size/Shape.</u> Scalable.</p> <p><u>Orientation.</u> The graphic is oriented upright on the display as shown in the example and is operator-centered over the desired location.</p>
<p>ICE SYSTEMS SEA ICE MELT PUDDLES OR FLOODED ICE</p> <p>Static/Dynamic: D Symbol Set Code: 46 Code: 110403</p> <p>Color: Black</p>		<p><u>Anchor Points.</u> This graphic requires one anchor point. The center point defines the center of the graphic.</p> <p><u>Size/Shape.</u> Scalable.</p> <p><u>Orientation.</u> The graphic is oriented upright on the display as shown in the example and is operator-centered over the desired location.</p>
<p>ICE SYSTEMS LIMITS</p> <p>Static/Dynamic: N/A Symbol Set Code: 46 Code: 110500</p>	<p>N/A</p>	<p>N/A</p>

TABLE I-II. Oceanographic icons - Continued.



DESCRIPTION	ICON	DRAW RULES
<p>ICE SYSTEMS LIMITS LIMIT OF VISUAL OBSERVATION</p> <p>Static/Dynamic: D Symbol Set Code: 46 Code: 110501</p> <p>Color: Black</p>		<p><u>Anchor Points.</u> This graphic requires at least two anchor points, points 1 and 2, to define the line. Additional points can be defined to extend the line.</p> <p><u>Size/Shape.</u> Scalable/Curve.</p> <p><u>Orientation.</u> The first and last anchor points determine the length of the line. The ovals will be repeated the entire length of the line.</p>
<p>ICE SYSTEMS LIMITS LIMIT OF UNDERCAST</p> <p>Static/Dynamic: D Symbol Set Code: 46 Code: 110502</p> <p>Color: Black</p>		<p><u>Anchor Points.</u> This graphic requires at least two anchor points, points 1 and 2, to define the line. Additional points can be defined to extend the line.</p> <p><u>Size/Shape.</u> Scalable/Curve. The points are typically connected with a series of wave-like shapes.</p> <p><u>Orientation.</u> The first and last anchor points determine the length of the line. The wave-like shapes will be repeated the entire length of the line.</p>
<p>ICE SYSTEMS LIMITS LIMIT OF RADAR OBSERVATION</p> <p>Static/Dynamic: D Symbol Set Code: 46 Code: 110503</p> <p>Color: Black</p>		<p><u>Anchor Points.</u> This graphic requires at least two anchor points, points 1 and 2, to define the line. Additional points can be defined to extend the line.</p> <p><u>Size/Shape.</u> Scalable/Curve. The points are typically connected with a solid curved line. The curvature of the line is operator defined.</p> <p><u>Orientation.</u> The first and last anchor points determine the length of the line. The ovals and 's will alternate the entire length of the line.</p>

TABLE I-II. Oceanographic icons - Continued.



DESCRIPTION	ICON	DRAW RULES
<p>ICE SYSTEMS LIMITS OBSERVED ICE EDGE OR BOUNDARY</p> <p>Static/Dynamic: D Symbol Set Code: 46 Code: 110504</p> <p>Color: Black</p>		<p><u>Anchor Points.</u> This graphic requires at least two anchor points, points 1 and 2, to define the line. Additional points can be defined to extend the line.</p> <p><u>Size/Shape.</u> Scalable/Curve. The points are typically connected with a solid curved line. The curvature of the line is operator defined.</p> <p><u>Orientation.</u> The first and last anchor points determine the length of the line.</p>
<p>ICE SYSTEMS LIMITS ESTIMATED ICE EDGE OR BOUNDARY</p> <p>Static/Dynamic: D Symbol Set Code: 46 Code: 110505</p> <p>Color: Black</p>		<p><u>Anchor Points.</u> This graphic requires at least two anchor points, points 1 and 2, to define the line. Additional points can be defined to extend the line.</p> <p><u>Size/Shape.</u> Scalable/Curve. The points are typically connected with a solid curved line. The curvature of the line is operator defined.</p> <p><u>Orientation.</u> The first and last anchor points determine the length of the line.</p>
<p>ICE SYSTEMS LIMITS ICE EDGE OR BOUNDARY FROM RADAR</p> <p>Static/Dynamic: D Symbol Set Code: 46 Code: 110506</p> <p>Color: Black</p>		<p><u>Anchor Points.</u> This graphic requires at least two anchor points, points 1 and 2, to define the line. Additional points can be defined to extend the line.</p> <p><u>Size/Shape.</u> Scalable/Curve. The points are typically connected with a curved line with Xs spaced evenly along the line. The curvature of the line is operator defined.</p> <p><u>Orientation.</u> The first and last anchor points determine the length of the line. The 'x's will be placed at regular intervals along the entire length of the line.</p>

TABLE I-II. Oceanographic icons - Continued.



DESCRIPTION	ICON	DRAW RULES
<p>ICE SYSTEMS OPENINGS IN THE ICE</p> <p>Static/Dynamic: N/A Symbol Set Code: 46 Code: 110600</p>	<p>N/A</p>	
<p>ICE SYSTEMS OPENINGS IN THE ICE CRACKS</p> <p>Static/Dynamic: D Symbol Set Code: 46 Code: 110601</p> <p>Color: Black</p>		<p><u>Anchor Points.</u> This graphic requires at least two anchor points, points 1 and 2, to define the line. Additional points can be defined to extend the line.</p> <p><u>Size/Shape.</u> Scalable/Curve. The points are typically connected with a curved line. The curvature of the line is operator defined.</p> <p><u>Orientation.</u> The first and last anchor points determine the length of the line.</p>
<p>ICE SYSTEMS OPENINGS IN THE ICE CRACKS AT A SPECIFIC LOCATION</p> <p>Static/Dynamic: D Symbol Set Code: 46 Code: 110602</p> <p>Color: Black</p>		<p><u>Anchor Points.</u> This graphic requires at least two anchor points, points 1 and 2, to define the line. Additional points can be defined to extend the line.</p> <p><u>Size/Shape.</u> Scalable/Curve. The points are typically connected with a curved line with perpendicular lines spaced evenly along the line. The curvature of the line is operator defined.</p> <p><u>Orientation.</u> The first and last anchor points determine the length of the line. The perpendicular lines will be placed at regular intervals along the entire length of the line.</p>

TABLE I-II. Oceanographic icons - Continued.



DESCRIPTION	ICON	DRAW RULES
<p>ICE SYSTEMS OPENINGS IN THE ICE LEAD</p> <p>Static/Dynamic: D Symbol Set Code: 46 Code: 110603</p> <p>Color: Black</p>		<p><u>Anchor Points.</u> This graphic requires at least two anchor points, points 1 and 2, to define the line. Additional points can be defined to extend the line.</p> <p><u>Size/Shape.</u> Scalable/Curve. The points are typically connected with parallel curved lines. The curvature of the line is operator defined.</p> <p><u>Orientation.</u> The first and last anchor points determine the length of the line.</p>
<p>ICE SYSTEMS OPENINGS IN THE ICE FROZEN LEAD</p> <p>Static/Dynamic: D Symbol Set Code: 46 Code: 110604</p> <p>Color: Black</p>		<p><u>Anchor Points.</u> This graphic requires at least two anchor points, points 1 and 2, to define the line. Additional points can be defined to extend the line.</p> <p><u>Size/Shape.</u> Scalable/Curve. The points are typically connected with parallel curved lines connected by vertical lines spaced evenly along the line. The curvature of the line is operator defined.</p> <p><u>Orientation.</u> The first and last anchor points determine the length of the line. The perpendicular lines joining the main lines will be placed at regular intervals along the entire length of the main lines.</p>
<p>ICE SYSTEMS SNOW COVER</p> <p>Static/Dynamic: D Symbol Set Code: 46 Code: 110700</p> <p>Color: Black</p>		<p><u>Anchor Points.</u> This graphic requires one anchor point. The center point defines the center of the graphic.</p> <p><u>Size/Shape.</u> Scalable.</p> <p><u>Orientation.</u> The graphic is oriented upright on the display as shown in the example and operator-centered over the desired location.</p>

TABLE I-II. Oceanographic icons - Continued.



DESCRIPTION	ICON	DRAW RULES
<p>ICE SYSTEMS SNOW COVER SASTRUGI (WITH ORIENTATION)</p> <p>Static/Dynamic: D Symbol Set Code: 46 Code: 110701</p> <p>Color: Black</p>		<p><u>Anchor Points.</u> This graphic requires one anchor point. The center point defines the center of the graphic.</p> <p><u>Size/Shape.</u> Scalable.</p> <p><u>Orientation.</u> The graphic is oriented upright on the display as shown in the example and operator-centered over the desired location.</p>
<p>ICE SYSTEMS TOPOGRAPHICAL FEATURES</p> <p>Static/Dynamic: N/A Symbol Set Code: 46 Code: 110800</p>	<p>N/A</p>	
<p>ICE SYSTEMS TOPOGRAPHICAL FEATURES RIDGES OR HUMMOCKS</p> <p>Static/Dynamic: D Symbol Set Code: 46 Code: 110801</p> <p>Color: Black</p>		<p><u>Anchor Points.</u> This graphic requires one anchor point. The center point defines the center of the graphic.</p> <p><u>Size/Shape.</u> Scalable.</p> <p><u>Orientation.</u> The graphic is oriented upright on the display as shown in the example and operator-centered over the desired location.</p>
<p>ICE SYSTEMS TOPOGRAPHICAL FEATURES RAFTING</p> <p>Static/Dynamic: D Symbol Set Code: 46 Code: 110802</p> <p>Color: Black</p>		<p><u>Anchor Points.</u> This graphic requires one anchor point. The center point defines the center of the graphic.</p> <p><u>Size/Shape.</u> Scalable.</p> <p><u>Orientation.</u> The graphic is oriented upright on the display as shown in the example and operator-centered over the desired location.</p>

TABLE I-II. Oceanographic icons - Continued.

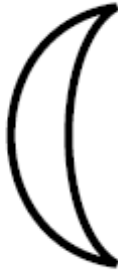

DESCRIPTION	ICON	DRAW RULES
<p>ICE SYSTEMS TOPOGRAPHICAL FEATURES JAMMED BRASH BARRIER</p> <p>Static/Dynamic: D Symbol Set Code: 46 Code: 110803</p> <p>Color: Black</p>		<p><u>Anchor Points.</u> This graphic requires one anchor point. The center point defines the center of the graphic.</p> <p><u>Size/Shape.</u> Scalable.</p> <p><u>Orientation.</u> The graphic is oriented upright on the display as shown in the example and operator-centered over the desired location.</p>
<p>HYDROGRAPHY</p> <p>Static/Dynamic: N/A Symbol Set Code: 46 Code: 120000</p>	<p>N/A</p>	
<p>HYDROGRAPHY DEPTH</p> <p>Static/Dynamic: N/A Symbol Set Code: 46 Code: 120100</p>	<p>N/A</p>	
<p>HYDROGRAPHY DEPTH SOUNDINGS</p> <p>Static/Dynamic: D Symbol Set Code: 46 Code: 120101</p> <p>Color: Grey</p>		<p><u>Anchor Points.</u> This graphic requires one anchor point. The center point defines the center of the graphic.</p> <p><u>Size/Shape.</u> Scalable.</p> <p><u>Orientation.</u> The graphic is oriented upright on the display as shown in the example and operator-centered over the desired location.</p>

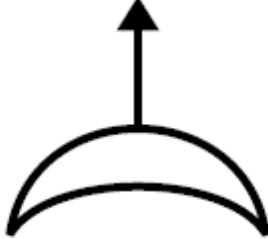
TABLE I-II. Oceanographic icons - Continued.



DESCRIPTION	ICON	DRAW RULES
<p>HYDROGRAPHY DEPTH DEPTH CURVE</p> <p>Static/Dynamic: S Symbol Set Code: 46 Code: 120102</p> <p>Color: Grey Thin Solid Line</p>		<p><u>Anchor Points.</u> This graphic requires at least two anchor points, points 1 and 2, to define the line. Additional points can be defined to extend the line.</p> <p><u>Size/Shape.</u> Scalable/Curve. The points are typically connected with a solid curved line. The curvature of the line is operator defined.</p> <p><u>Orientation.</u> The first and last anchor points determine the length of the line. The modifier text will be placed at each end of the line and at regular intervals along the line.</p>
<p>HYDROGRAPHY DEPTH DEPTH CONTOUR</p> <p>Static/Dynamic: S Symbol Set Code: 46 Code: 120103</p> <p>Color: Grey Thin Solid Line</p>		<p><u>Anchor Points.</u> This graphic requires at least two anchor points, points 1 and 2, to define the line. Additional points can be defined to extend the line.</p> <p><u>Size/Shape.</u> Scalable/Curve.</p> <p><u>Orientation.</u> The first and last anchor points determine the length of the line. The modifier text will be placed at each end of the line and at regular intervals along the line.</p>
<p>HYDROGRAPHY DEPTH DEPTH AREA</p> <p>Static/Dynamic: S Symbol Set Code: 46 Code: 120104</p> <p>Color: Blue/Pale Blue/White</p>		<p><u>Anchor Points.</u> This graphic requires at least three anchor points to define the boundary of the area. Add as many points as necessary to accurately reflect the area's size and shape.</p> <p><u>Size/Shape.</u> Determined by the anchor points. The points are connected with a solid line.</p> <p><u>Orientation.</u> Not applicable.</p>
<p>HYDROGRAPHY COASTAL HYDROGRAPHY</p> <p>Static/Dynamic: N/A Symbol Set Code: 46 Code: 120200</p>	<p>N/A</p>	

TABLE I-II. Oceanographic icons - Continued.





DESCRIPTION	ICON	DRAW RULES
<p>HYDROGRAPHY COASTAL HYDROGRAPHY COASTLINE</p> <p>Static/Dynamic: S Symbol Set Code: 46 Code: 120201</p> <p>Color: Gray thin solid line</p>		<p><u>Anchor Points.</u> This graphic requires at least two anchor points, points 1 and 2, to define the line. Additional points can be defined to extend the line.</p> <p><u>Size/Shape.</u> Scalable/Curve. The points are connected with a solid line.</p> <p><u>Orientation.</u> The first and last anchor points determine the length of the line.</p>
<p>HYDROGRAPHY COASTAL HYDROGRAPHY ISLAND</p> <p>Static/Dynamic: S Symbol Set Code: 46 Code: 120202</p> <p>Color: Brown solid fill</p>		<p><u>Anchor Points.</u> This graphic requires at least three anchor points to define the boundary of the area. Add as many points as necessary to accurately reflect the area's size and shape.</p> <p><u>Size/Shape.</u> Determined by the anchor points. The points are connected with a solid line.</p> <p><u>Orientation.</u> Not applicable.</p>
<p>HYDROGRAPHY COASTAL HYDROGRAPHY BEACH</p> <p>Static/Dynamic: S Symbol Set Code: 46 Code: 120203</p> <p>Color: Beige outline and stipple fill</p>		<p><u>Anchor Points.</u> This graphic requires at least three anchor points to define the boundary of the area. Add as many points as necessary to accurately reflect the area's size and shape.</p> <p><u>Size/Shape.</u> Determined by the anchor points. The points are connected with a solid line.</p> <p><u>Orientation.</u> Not applicable.</p>
<p>HYDROGRAPHY COASTAL HYDROGRAPHY WATER</p> <p>Static/Dynamic: S Symbol Set Code: 46 Code: 120204</p> <p>Color: White fill (grey dashed line shown for representation purpose only).</p>		<p><u>Anchor Points.</u> This graphic requires at least three anchor points to define the boundary of the area. Add as many points as necessary to accurately reflect the area's size and shape.</p> <p><u>Size/Shape.</u> Determined by the anchor points. The points are connected with a dashed line.</p> <p><u>Orientation.</u> Not applicable.</p>

TABLE I-II. Oceanographic icons - Continued.

DESCRIPTION	ICON	DRAW RULES
<p>HYDROGRAPHY COASTAL HYDROGRAPHY FORESHORE - LINE</p> <p>Static/Dynamic: S Symbol Set Code: 46 Code: 120205</p> <p>Color: Yellow-green solid line</p>		<p><u>Anchor Points.</u> This graphic requires at least two anchor points, points 1 and 2, to define the line. Additional points can be defined to extend the line.</p> <p><u>Size/Shape.</u> Scalable/Curve.</p> <p><u>Orientation.</u> The first and last anchor points determine the length of the line.</p>
<p>HYDROGRAPHY COASTAL HYDROGRAPHY FORESHORE - AREA</p> <p>Static/Dynamic: S Symbol Set Code: 46 Code: 120206</p> <p>Color: Yellow-green solid fill</p>		<p><u>Anchor Points.</u> This graphic requires at least three anchor points to define the boundary of the area. Add as many points as necessary to accurately reflect the area's size and shape.</p> <p><u>Size/Shape.</u> Determined by the anchor points.</p> <p><u>Orientation.</u> Not applicable.</p>
<p>HYDROGRAPHY PORTS AND HARBORS</p> <p>Static/Dynamic: N/A Symbol Set Code: 46 Code: 120300</p>	<p>N/A</p>	<p>N/A</p>
<p>HYDROGRAPHY PORTS AND HARBORS PORTS</p> <p>Static/Dynamic: N/A Symbol Set Code: 46 Code: 120301</p>	<p>N/A</p>	<p>N/A</p>
<p>HYDROGRAPHY PORTS AND HARBORS PORTS BERTHS (ONSHORE)</p> <p>Static/Dynamic: S Symbol Set Code: 46 Code: 120302</p> <p>Color: Magenta small circle</p>		<p><u>Anchor Points.</u> This graphic requires one anchor point. The center point defines the center of the graphic.</p> <p><u>Size/Shape.</u> Scalable.</p> <p><u>Orientation.</u> The graphic is typically centered over the desired location.</p>

TABLE I-II. Oceanographic icons - Continued.

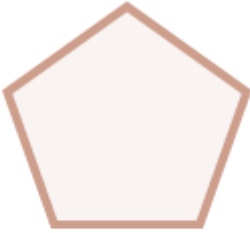

DESCRIPTION	ICON	DRAW RULES
<p>HYDROGRAPHY PORTS AND HARBORS PORTS BERTHS (ANCHOR)</p> <p>Static/Dynamic: S Symbol Set Code: 46 Code: 120303</p> <p>Color: Magenta anchor w/ small circle</p>		<p><u>Anchor Points.</u> This graphic requires one anchor point. The center point defines the center of the graphic.</p> <p><u>Size/Shape.</u> Scalable.</p> <p><u>Orientation.</u> The graphic is oriented upright on the display as shown in the example and operator-centered over the desired location.</p>
<p>HYDROGRAPHY PORTS AND HARBORS PORTS ANCHORAGE - POINT</p> <p>Static/Dynamic: S Symbol Set Code: 46 Code: 120304</p> <p>Color: Magenta anchor</p>		<p><u>Anchor Points.</u> This graphic requires one anchor point. The center point defines the center of the graphic.</p> <p><u>Size/Shape.</u> Scalable.</p> <p><u>Orientation.</u> The graphic is oriented upright on the display as shown in the example and operator-centered over the desired location.</p>
<p>HYDROGRAPHY PORTS AND HARBORS PORTS ANCHORAGE - LINE</p> <p>Static/Dynamic: S Symbol Set Code: 46 Code: 120305</p> <p>Color: Magenta</p> <p>Magenta dash/chevron line w/ anchor symbol</p>		<p><u>Anchor Points.</u> This graphic requires at least two anchor points, points 1 and 2, to define the line. Additional points can be defined to extend the line.</p> <p><u>Size/Shape.</u> Scalable.</p> <p><u>Orientation.</u> The graphic is oriented upright on the display as shown in the example and operator-centered over the desired location.</p>
<p>HYDROGRAPHY PORTS AND HARBORS PORTS ANCHORAGE - AREA</p> <p>Static/Dynamic: S Symbol Set Code: 46 Code: 120306</p> <p>Color: Magenta</p> <p>Magenta dash/chevron outline w/ anchor</p>		<p><u>Anchor Points.</u> This graphic requires at least three anchor points to define the boundary of the area. Add as many points as necessary to accurately reflect the area's size and shape.</p> <p><u>Size/Shape.</u> Determined by the anchor points.</p> <p><u>Orientation.</u> Not applicable.</p>

TABLE I-II. Oceanographic icons - Continued.

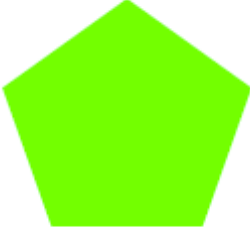
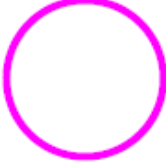

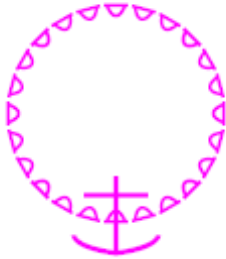

DESCRIPTION	ICON	DRAW RULES
<p>HYDROGRAPHY PORTS AND HARBORS PORTS CALL IN POINT</p> <p>Static/Dynamic: S Symbol Set Code: 46 Code: 120307 Color: Magenta circle w/ two cones</p>		<p><u>Anchor Points.</u> This graphic requires one anchor point. The center point defines the center of the graphic.</p> <p><u>Size/Shape.</u> Scalable.</p> <p><u>Orientation.</u> The graphic is typically centered over the desired location.</p>
<p>HYDROGRAPHY PORTS AND HARBORS PORTS PIER/WHARF/QUAY</p> <p>Static/Dynamic: S Symbol Set Code: 46 Code: 120308 Color: Gray thin solid line</p>		<p><u>Anchor Points.</u> This graphic requires at least two anchor points, points 1 and 2, to define the line. Additional points can be defined to extend the line.</p> <p><u>Size/Shape.</u> Scalable.</p> <p><u>Orientation.</u> The first and last anchor points determine the length of the line.</p>
<p>HYDROGRAPHY PORTS AND HARBORS FISHING HARBOR - POINT</p> <p>Static/Dynamic: S Symbol Set Code: 46 Code: 120309 Color: Magenta</p> <p>Magenta fish w/arcs above and below</p>		<p><u>Anchor Points.</u> This graphic requires one anchor point. The center point defines the center of the graphic.</p> <p><u>Size/Shape.</u> Scalable.</p> <p><u>Orientation.</u> The graphic is typically centered over the desired location.</p>
<p>HYDROGRAPHY PORTS AND HARBORS FISH WEIRS - POINT</p> <p>Static/Dynamic: S Symbol Set Code: 46 Code: 120310 Color: Gray fish inside net</p>		<p><u>Anchor Points.</u> This graphic requires one anchor point. The center point defines the center of the graphic.</p> <p><u>Size/Shape.</u> Scalable.</p> <p><u>Orientation.</u> The graphic is typically centered over the desired location.</p>

TABLE I-II. Oceanographic icons - Continued.

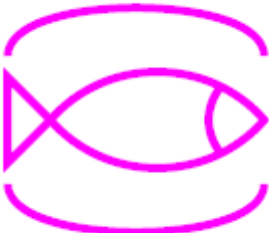

DESCRIPTION	ICON	DRAW RULES
<p>HYDROGRAPHY PORTS AND HARBORS FISH STAKES - POINT</p> <p>Static/Dynamic: S Symbol Set Code: 46 Code: 120311</p> <p>Color: Gray L Style: repeating pattern of gray L's</p>		<p><u>Anchor Points.</u> This graphic requires one anchor point. The center point defines the center of the graphic.</p> <p><u>Size/Shape.</u> Scalable.</p> <p><u>Orientation.</u> The graphic is typically centered over the desired location.</p>
<p>HYDROGRAPHY PORTS AND HARBORS FISH TRAPS - AREA</p> <p>Static/Dynamic: S Symbol Set Code: 46 Code: 120312</p> <p>Color: Gray</p> <p>Gray rectangle below angle line pattern fill dashed outline</p>		<p><u>Anchor Points.</u> This graphic requires at least three anchor points to define the boundary of the area. Add as many points as necessary to accurately reflect the area's size and shape.</p> <p><u>Size/Shape.</u> Determined by the anchor points.</p> <p><u>Orientation.</u> Not applicable.</p>
<p>HYDROGRAPHY PORTS AND HARBORS FACILITIES</p> <p>Static/Dynamic: N/A Symbol Set Code: 46 Code: 120313</p>	<p>N/A</p>	<p>N/A</p>
<p>HYDROGRAPHY PORTS AND HARBORS FACILITIES DRYDOCK</p> <p>Static/Dynamic: S Symbol Set Code: 46 Code: 120314</p> <p>Color: Brown/Black</p> <p>Brown solid area w/ black thin outline</p>		<p><u>Anchor Points.</u> This graphic requires at least three anchor points to define the boundary of the area. Add as many points as necessary to accurately reflect the area's size and shape.</p> <p><u>Size/Shape.</u> Determined by the anchor points.</p> <p><u>Orientation.</u> Not applicable.</p>

TABLE I-II. Oceanographic icons - Continued.



DESCRIPTION	ICON	DRAW RULES
<p>HYDROGRAPHY PORTS AND HARBORS FACILITIES LANDING PLACE</p> <p>Static/Dynamic: S Symbol Set Code: 46 Code: 120315</p> <p>Color: Magenta yacht inside circle</p>		<p><u>Anchor Points.</u> This graphic requires one anchor point. The center point defines the center of the graphic.</p> <p><u>Size/Shape.</u> Scalable.</p> <p><u>Orientation.</u> The graphic is typically centered over the desired location.</p>
<p>HYDROGRAPHY PORTS AND HARBORS FACILITIES OFFSHORE LOADING FACILITY - POINT</p> <p>Static/Dynamic: S Symbol Set Code: 46 Code: 120316</p> <p>Color: Black installation buoy</p>		<p><u>Anchor Points.</u> This graphic requires one anchor point. The center point defines the center of the graphic.</p> <p><u>Size/Shape.</u> Scalable.</p> <p><u>Orientation.</u> The graphic is typically centered over the desired location.</p>
<p>HYDROGRAPHY PORTS AND HARBORS FACILITIES OFFSHORE LOADING FACILITY - LINE</p> <p>Static/Dynamic: S Symbol Set Code: 46 Code: 120317</p> <p>Color: Grey thick solid line</p>		<p><u>Anchor Points.</u> This graphic requires at least two anchor points, points 1 and 2, to define the line. Additional points can be defined to extend the line.</p> <p><u>Size/Shape.</u> Scalable.</p> <p><u>Orientation.</u> The first and last anchor points determine the length of the line.</p>
<p>HYDROGRAPHY PORTS AND HARBORS FACILITIES OFFSHORE LOADING FACILITY - AREA</p> <p>Static/Dynamic: S Symbol Set Code: 46 Code: 120318</p> <p>Color: Brown solid fill</p>		<p><u>Anchor Points.</u> This graphic requires at least three anchor points to define the boundary of the area. Add as many points as necessary to accurately reflect the area's size and shape.</p> <p><u>Size/Shape.</u> Determined by the anchor points.</p> <p><u>Orientation.</u> Not applicable.</p>

TABLE I-II. Oceanographic icons - Continued.



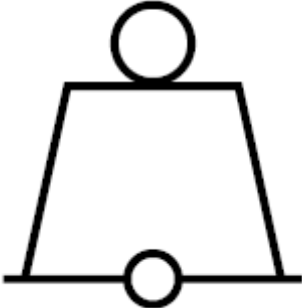
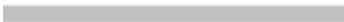

DESCRIPTION	ICON	DRAW RULES
<p>HYDROGRAPHY PORTS AND HARBORS FACILITIES RAMP - ABOVE WATER</p> <p>Static/Dynamic: S Symbol Set Code: 46 Code: 120319</p> <p>Color: Black solid line</p>		<p><u>Anchor Points.</u> This graphic requires at least two anchor points, points 1 and 2, to define the line. Additional points can be defined to extend the line.</p> <p><u>Size/Shape.</u> Scalable.</p> <p><u>Orientation.</u> The first and last anchor points determine the length of the line.</p>
<p>HYDROGRAPHY PORTS AND HARBORS FACILITIES RAMP - BELOW WATER</p> <p>Static/Dynamic: S Symbol Set Code: 46 Code: 120320</p> <p>Color: Black dashed line</p>		<p><u>Anchor Points.</u> This graphic requires at least two anchor points, points 1 and 2, to define the line. Additional points can be defined to extend the line.</p> <p><u>Size/Shape.</u> Scalable.</p> <p><u>Orientation.</u> The first and last anchor points determine the length of the line.</p>
<p>HYDROGRAPHY PORTS AND HARBORS FACILITIES LANDING RING</p> <p>Static/Dynamic: S Symbol Set Code: 46 Code: 120321</p> <p>Color: Dark Brown/Black</p> <p>Dark Brown filled square w/ black outline</p>		<p><u>Anchor Points.</u> This graphic requires one anchor point. The center point defines the center of the graphic.</p> <p><u>Size/Shape.</u> Scalable.</p> <p><u>Orientation.</u> The graphic is typically centered over the desired location.</p>
<p>HYDROGRAPHY PORTS AND HARBORS FACILITIES FERRY CROSSING</p> <p>Static/Dynamic: S Symbol Set Code: 46 Code: 120322</p> <p>Color: Magenta</p> <p>Magenta dashed line w/ boat symbol</p>		<p><u>Anchor Points.</u> This graphic requires one anchor point. The center point defines the center of the graphic.</p> <p><u>Size/Shape.</u> Scalable.</p> <p><u>Orientation.</u> The graphic is typically centered over the desired location.</p>

TABLE I-II. Oceanographic icons - Continued.



DESCRIPTION	ICON	DRAW RULES
<p>HYDROGRAPHY PORTS AND HARBORS FACILITIES CABLE FERRY CROSSING</p> <p>Static/Dynamic: S Symbol Set Code: 46 Code: 120323</p> <p>Color: Black</p> <p>Black dashed line w/ boat symbol</p>		<p><u>Anchor Points.</u> This graphic requires one anchor point. The center point defines the center of the graphic.</p> <p><u>Size/Shape.</u> Scalable.</p> <p><u>Orientation.</u> The graphic is typically centered over the desired location.</p>
<p>HYDROGRAPHY PORTS AND HARBORS FACILITIES DOLPHIN</p> <p>Static/Dynamic: S Symbol Set Code: 46 Code: 120324</p> <p>Color: Dark Brown/Black</p> <p>Dark Brown filled square w/ black outline</p>		<p><u>Anchor Points.</u> This graphic requires one anchor point. The center point defines the center of the graphic.</p> <p><u>Size/Shape.</u> Scalable.</p> <p><u>Orientation.</u> The graphic is typically centered over the desired location.</p>
<p>HYDROGRAPHY PORTS AND HARBORS SHORELINE PROTECTION</p> <p>Static/Dynamic: N/A Symbol Set Code: 46 Code: 120325</p>	<p>N/A</p>	<p>N/A</p>
<p>HYDROGRAPHY PORTS AND HARBORS SHORELINE PROTECTION BREAKWATER/GROIN/JETTY - ABOVE WATER</p> <p>Static/Dynamic: S Symbol Set Code: 46 Code: 120326</p> <p>Color: Grey solid line</p>		<p><u>Anchor Points.</u> This graphic requires at least two anchor points, points 1 and 2, to define the line. Additional points can be defined to extend the line.</p> <p><u>Size/Shape.</u> Scalable.</p> <p><u>Orientation.</u> The first and last anchor points determine the length of the line.</p>

TABLE I-II. Oceanographic icons - Continued.



DESCRIPTION	ICON	DRAW RULES
<p>HYDROGRAPHY PORTS AND HARBORS SHORELINE PROTECTION BREAKWATER/GROIN/JETTY - BELOW WATER</p> <p>Static/Dynamic: S Symbol Set Code: 46 Code: 120327</p> <p>Color: Grey dashed line</p>		<p><u>Anchor Points.</u> This graphic requires at least two anchor points, points 1 and 2, to define the line. Additional points can be defined to extend the line.</p> <p><u>Size/Shape.</u> Scalable.</p> <p><u>Orientation.</u> The first and last anchor points determine the length of the line.</p>
<p>HYDROGRAPHY PORTS AND HARBORS SHORELINE PROTECTION SEAWALL</p> <p>Static/Dynamic: S Symbol Set Code: 46 Code: 120328</p> <p>Color: Grey solid line</p>		<p><u>Anchor Points.</u> This graphic requires at least two anchor points, points 1 and 2, to define the line. Additional points can be defined to extend the line.</p> <p><u>Size/Shape.</u> Scalable.</p> <p><u>Orientation.</u> The first and last anchor points determine the length of the line.</p>
<p>HYDROGRAPHY AIDS TO NAVIGATION</p> <p>Static/Dynamic: N/A Symbol Set Code: 46 Code: 120400</p>	<p>N/AError! Bookmark not defined.</p>	<p>N/A</p>
<p>HYDROGRAPHY AIDS TO NAVIGATION BEACON</p> <p>Static/Dynamic: S Symbol Set Code: 46 Code: 120401</p> <p>Color: Black beacon/buoy base</p>		<p><u>Anchor Points.</u> This graphic requires one anchor point. The center point defines the center of the graphic.</p> <p><u>Size/Shape.</u> Scalable.</p> <p><u>Orientation.</u> The graphic is typically centered over the desired location.</p>

TABLE I-II. Oceanographic icons - Continued.



DESCRIPTION	ICON	DRAW RULES
<p>HYDROGRAPHY AIDS TO NAVIGATION BUOY DEFAULT</p> <p>Static/Dynamic: S Symbol Set Code: 46 Code: 120402</p> <p>Color: Black/Magenta</p> <p>Black default buoy beside magenta question mark</p>		<p><u>Anchor Points.</u> This graphic requires one anchor point. The center point defines the center of the graphic.</p> <p><u>Size/Shape.</u> Scalable.</p> <p><u>Orientation.</u> The graphic is typically centered over the desired location.</p>
<p>HYDROGRAPHY AIDS TO NAVIGATION MARKER</p> <p>Static/Dynamic: S Symbol Set Code: 46 Code: 120403</p> <p>Color: Magenta</p> <p>Magenta Inverted T with open circle at bottom below box</p>		<p><u>Anchor Points.</u> This graphic requires one anchor point. The center point defines the center of the graphic.</p> <p><u>Size/Shape.</u> Scalable.</p> <p><u>Orientation.</u> The graphic is typically centered over the desired location.</p>
<p>HYDROGRAPHY AIDS TO NAVIGATION PERCHES/STAKES - POINT</p> <p>Static/Dynamic: S Symbol Set Code: 46 Code: 120404</p> <p>Color: Black small circle</p>		<p><u>Anchor Points.</u> This graphic requires one anchor point. The center point defines the center of the graphic.</p> <p><u>Size/Shape.</u> Scalable.</p> <p><u>Orientation.</u> The graphic is typically centered over the desired location.</p>
<p>HYDROGRAPHY AIDS TO NAVIGATION PERCHES/STAKES - AREA</p> <p>Static/Dynamic: D Symbol Set Code: 46 Code: 120405</p> <p>Color: Blue/Black</p> <p>Blue Fill with black dot outline</p>		<p><u>Anchor Points.</u> This graphic requires at least three anchor points to define the boundary of the area. Add as many points as necessary to accurately reflect the area's size and shape.</p> <p><u>Size/Shape.</u> Determined by the anchor points.</p> <p><u>Orientation.</u> Not applicable.</p>

TABLE I-II. Oceanographic icons - Continued.

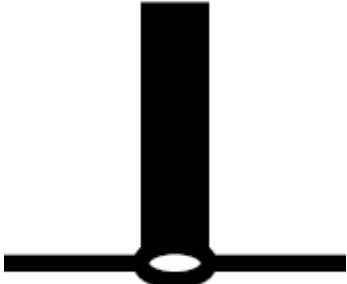

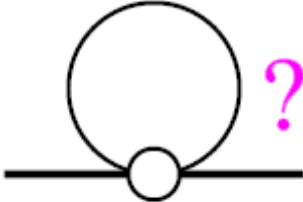
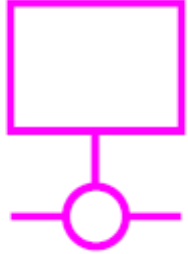

DESCRIPTION	ICON	DRAW RULES
<p>HYDROGRAPHY AIDS TO NAVIGATION LIGHT</p> <p>Static/Dynamic: S Symbol Set Code: 46 Code: 120406</p> <p>Color: Magenta flare</p>		<p><u>Anchor Points.</u> This graphic requires one anchor point. The center point defines the center of the graphic.</p> <p><u>Size/Shape.</u> Scalable.</p> <p><u>Orientation.</u> The graphic is typically centered over the desired location.</p>
<p>HYDROGRAPHY AIDS TO NAVIGATION LEADING LINE</p> <p>Static/Dynamic: D Symbol Set Code: 46 Code: 120407</p> <p>Color: Black solid to dashed line</p>		<p><u>Anchor Points.</u> This graphic requires at least two anchor points, points 1 and 2, to define the line. Additional points can be defined to extend the line.</p> <p><u>Size/Shape.</u> Scalable.</p> <p><u>Orientation.</u> The first and last anchor points determine the length of the line.</p>
<p>HYDROGRAPHY AIDS TO NAVIGATION LIGHT VESSEL/LIGHT SHIP</p> <p>Static/Dynamic: S Symbol Set Code: 46 Code: 120408</p> <p>Color: Black light vessel</p>		<p><u>Anchor Points.</u> This graphic requires one anchor point. The center point defines the center of the graphic.</p> <p><u>Size/Shape.</u> Scalable.</p> <p><u>Orientation.</u> The graphic is typically centered over the desired location.</p>
<p>HYDROGRAPHY AIDS TO NAVIGATION LIGHTHOUSE</p> <p>Static/Dynamic: S Symbol Set Code: 46 Code: 120409</p> <p>Color: Black lighthouse symbol</p>		<p><u>Anchor Points.</u> This graphic requires one anchor point. The center point defines the center of the graphic.</p> <p><u>Size/Shape.</u> Scalable.</p> <p><u>Orientation.</u> The graphic is typically centered over the desired location.</p>

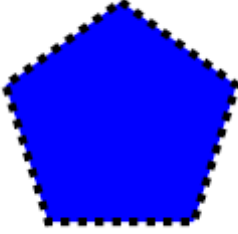
TABLE I-II. Oceanographic icons - Continued.

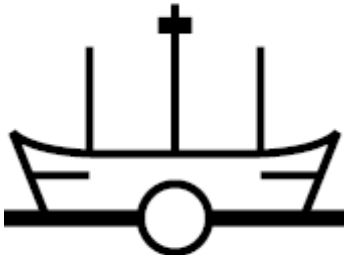

DESCRIPTION	ICON	DRAW RULES
<p>HYDROGRAPHY DANGERS/HAZARDS</p> <p>Static/Dynamic: N/A Symbol Set Code: 46 Code: 120500</p>	<p>N/A</p>	<p>N/A</p>
<p>HYDROGRAPHY DANGERS/HAZARDS ROCK SUBMERGED</p> <p>Static/Dynamic: S Symbol Set Code: 46 Code: 120501</p> <p>Color: Blue/Black</p> <p>Black cross in blue solid circle w/ black dotted outline</p>		<p><u>Anchor Points.</u> This graphic requires one anchor point. The center point defines the center of the graphic.</p> <p><u>Size/Shape.</u> Scalable.</p> <p><u>Orientation.</u> The graphic is typically centered over the desired location.</p>
<p>HYDROGRAPHY DANGERS/HAZARDS ROCK AWASHED</p> <p>Static/Dynamic: S Symbol Set Code: 46 Code: 120502</p> <p>Color: Black 6 point asterisk</p>		<p><u>Anchor Points.</u> This graphic requires one anchor point. The center point defines the center of the graphic.</p> <p><u>Size/Shape.</u> Scalable.</p> <p><u>Orientation.</u> The graphic is typically centered over the desired location.</p>
<p>HYDROGRAPHY DANGERS/HAZARDS UNDERWATER DANGER/HAZARD</p> <p>Static/Dynamic: D Symbol Set Code: 46 Code: 120503</p> <p>Color: Blue/Black</p> <p>Blue fill w/ black dot outline</p>		<p><u>Anchor Points.</u> This graphic requires at least three anchor points to define the boundary of the area. Add as many points as necessary to accurately reflect the area's size and shape.</p> <p><u>Size/Shape.</u> Determined by the anchor points.</p> <p><u>Orientation.</u> Not applicable.</p>

TABLE I-II. Oceanographic icons - Continued.



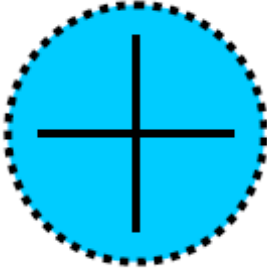

DESCRIPTION	ICON	DRAW RULES
<p>HYDROGRAPHY DANGERS/HAZARDS FOUL GROUND - POINT</p> <p>Static/Dynamic: S Symbol Set Code: 46 Code: 120504</p> <p>Color: Gray</p> <p>Gray pound (#) symbol</p>		<p><u>Anchor Points.</u> This graphic requires one anchor point. The center point defines the center of the graphic.</p> <p><u>Size/Shape.</u> Scalable.</p> <p><u>Orientation.</u> The graphic is typically centered over the desired location.</p>
<p>HYDROGRAPHY DANGERS/HAZARDS FOUL GROUND - AREA</p> <p>Static/Dynamic: D Symbol Set Code: 46 Code: 120505</p> <p>Color: Gray</p> <p>Gray # offset pattern fill</p>		<p><u>Anchor Points.</u> This graphic requires at least three anchor points to define the boundary of the area. Add as many points as necessary to accurately reflect the area's size and shape.</p> <p><u>Size/Shape.</u> Determined by the anchor points.</p> <p><u>Orientation.</u> Not applicable.</p>
<p>HYDROGRAPHY DANGERS/HAZARDS KELP/SEAWEED - POINT</p> <p>Static/Dynamic: D Symbol Set Code: 46 Code: 120506</p> <p>Color: Gray kelp symbol</p>		<p><u>Anchor Points.</u> This graphic requires one anchor point. The center point defines the center of the graphic.</p> <p><u>Size/Shape.</u> Scalable.</p> <p><u>Orientation.</u> The graphic is typically centered over the desired location.</p>
<p>HYDROGRAPHY DANGERS/HAZARDS KELP/SEAWEED - AREA</p> <p>Static/Dynamic: D Symbol Set Code: 46 Code: 120507</p> <p>Color: Gray kelp symbol pattern fill</p>		<p><u>Anchor Points.</u> This graphic requires at least three anchor points to define the boundary of the area. Add as many points as necessary to accurately reflect the area's size and shape.</p> <p><u>Size/Shape.</u> Determined by the anchor points.</p> <p><u>Orientation.</u> Not applicable.</p>

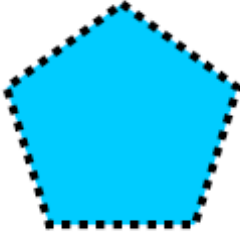
TABLE I-II. Oceanographic icons - Continued.





DESCRIPTION	ICON	DRAW RULES
<p>HYDROGRAPHY DANGERS/HAZARDS SNAGS/STUMPS</p> <p>Static/Dynamic: S Symbol Set Code: 46 Code: 120508</p> <p>Color: Blue/Black</p> <p>Blue oval w/ black dotted outline</p>		<p><u>Anchor Points.</u> This graphic requires one anchor point. The center point defines the center of the graphic.</p> <p><u>Size/Shape.</u> Scalable.</p> <p><u>Orientation.</u> The graphic is typically centered over the desired location.</p>
<p>HYDROGRAPHY DANGERS/HAZARDS WRECK (UNCOVERS)</p> <p>Static/Dynamic: S Symbol Set Code: 46 Code: 120509</p> <p>Color: Grey wreck symbol</p>		<p><u>Anchor Points.</u> This graphic requires one anchor point. The center point defines the center of the graphic.</p> <p><u>Size/Shape.</u> Scalable.</p> <p><u>Orientation.</u> The graphic is typically centered over the desired location.</p>
<p>HYDROGRAPHY DANGERS/HAZARDS WRECK (SUBMERGED)</p> <p>Static/Dynamic: S Symbol Set Code: 46 Code: 120510</p> <p>Color: Blue/Black</p> <p>Black horizontal bar w/ 3 ticks in blue solid oval w/ black dotted outline</p>		<p><u>Anchor Points.</u> This graphic requires one anchor point. The center point defines the center of the graphic.</p> <p><u>Size/Shape.</u> Scalable.</p> <p><u>Orientation.</u> The graphic is typically centered over the desired location.</p>
<p>HYDROGRAPHY DANGERS/HAZARDS BREAKERS</p> <p>Static/Dynamic: D Symbol Set Code: 46 Code: 120511</p> <p>Color: Gray thin dashed line</p>		<p><u>Anchor Points.</u> This graphic requires at least two anchor points, points 1 and 2, to define the line. Additional points can be defined to extend the line.</p> <p><u>Size/Shape.</u> Scalable/Curve.</p> <p><u>Orientation.</u> The first and last anchor points determine the length of the line.</p>

TABLE I-II. Oceanographic icons - Continued.



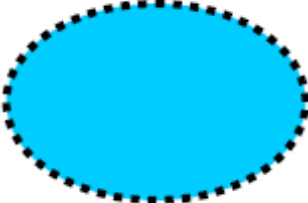

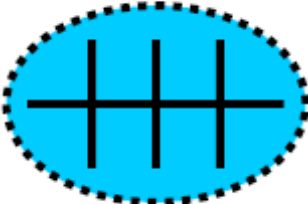
DESCRIPTION	ICON	DRAW RULES
<p>HYDROGRAPHY DANGERS/HAZARDS REEF</p> <p>Static/Dynamic: S Symbol Set Code: 46 Code: 120512</p> <p>Color: Black jagged line</p>		<p><u>Anchor Points.</u> This graphic requires at least two anchor points, points 1 and 2, to define the line. Additional points can be defined to extend the line.</p> <p><u>Size/Shape.</u> Scalable/Curve.</p> <p><u>Orientation.</u> The first and last anchor points determine the length of the line.</p>
<p>HYDROGRAPHY DANGERS/HAZARDS EDDIES/OVERFALLS/TIDE RIPS</p> <p>Static/Dynamic: S Symbol Set Code: 46 Code: 120513</p> <p>Color: Gray</p>		<p><u>Anchor Points.</u> This graphic requires one anchor point. The center point defines the center of the graphic.</p> <p><u>Size/Shape.</u> Scalable.</p> <p><u>Orientation.</u> The graphic is typically centered over the desired location.</p>
<p>HYDROGRAPHY DANGERS/HAZARDS DISCOLORED WATER</p> <p>Static/Dynamic: S Symbol Set Code: 46 Code: 120514</p> <p>Color: Blue/Black</p> <p>Blue filled w/ black dot outline</p>		<p><u>Anchor Points.</u> This graphic requires at least three anchor points to define the boundary of the area. Add as many points as necessary to accurately reflect the area's size and shape.</p> <p><u>Size/Shape.</u> Determined by the anchor points.</p> <p><u>Orientation.</u> Not applicable.</p>
<p>HYDROGRAPHY BOTTOM FEATURES</p> <p>Static/Dynamic: N/A Symbol Set Code: 46 Code: 120600</p>	<p>N/A</p>	<p>N/A</p>
<p>HYDROGRAPHY BOTTOM FEATURES BOTTOM CHARACTERISTICS - SAND</p> <p>Static/Dynamic: S Symbol Set Code: 46 Code: 120601</p> <p>Color: Black</p>		<p><u>Anchor Points.</u> This graphic requires one anchor point. The center point defines the center of the graphic.</p> <p><u>Size/Shape.</u> Scalable.</p> <p><u>Orientation.</u> The graphic is typically centered over the desired location.</p>

TABLE I-II. Oceanographic icons - Continued.

DESCRIPTION	ICON	DRAW RULES
HYDROGRAPHY BOTTOM FEATURES BOTTOM CHARACTERISTICS - MUD Static/Dynamic: S Symbol Set Code: 46 Code: 120602 Color: Black	<i>M</i>	<u>Anchor Points.</u> This graphic requires one anchor point. The center point defines the center of the graphic. <u>Size/Shape.</u> Scalable. <u>Orientation.</u> The graphic is typically centered over the desired location.
HYDROGRAPHY BOTTOM FEATURES BOTTOM CHARACTERISTICS - CLAY Static/Dynamic: S Symbol Set Code: 46 Code: 120603 Color: Black	<i>Cy</i>	<u>Anchor Points.</u> This graphic requires one anchor point. The center point defines the center of the graphic. <u>Size/Shape.</u> Scalable. <u>Orientation.</u> The graphic is typically centered over the desired location.
HYDROGRAPHY BOTTOM FEATURES BOTTOM CHARACTERISTICS - SILT Static/Dynamic: S Symbol Set Code: 46 Code: 120604 Color: Black	<i>Si</i>	<u>Anchor Points.</u> This graphic requires one anchor point. The point defines the geometric center of the graphic. <u>Size/Shape.</u> Not applicable. <u>Orientation.</u> The graphic is oriented upright on the display as shown in the example and operator-centered over the desired location.
HYDROGRAPHY BOTTOM FEATURES BOTTOM CHARACTERISTICS - STONES Static/Dynamic: S Symbol Set Code: 46 Code: 120605 Color: Black	<i>St</i>	<u>Anchor Points.</u> This graphic requires one anchor point. The point defines the geometric center of the graphic. <u>Size/Shape.</u> Not applicable. <u>Orientation.</u> The graphic is oriented upright on the display as shown in the example and operator-centered over the desired location.

TABLE I-II. Oceanographic icons - Continued.

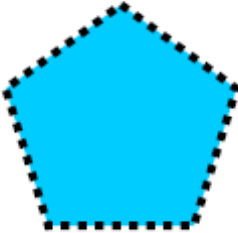
DESCRIPTION	ICON	DRAW RULES
HYDROGRAPHY BOTTOM FEATURES BOTTOM CHARACTERISTICS - GRAVEL Static/Dynamic: S Symbol Set Code: 46 Code: 120606 Color: Black	<i>G</i>	<u>Anchor Points.</u> This graphic requires one anchor point. The point defines the geometric center of the graphic. <u>Size/Shape.</u> Not applicable. <u>Orientation.</u> The graphic is oriented upright on the display as shown in the example and operator-centered over the desired location.
HYDROGRAPHY BOTTOM FEATURES BOTTOM CHARACTERISTICS - PEBBLES Static/Dynamic: S Symbol Set Code: 46 Code: 120607 Color: Black	<i>P</i>	<u>Anchor Points.</u> This graphic requires one anchor point. The center point defines the center of the graphic. <u>Size/Shape.</u> Scalable. <u>Orientation.</u> The graphic is typically centered over the desired location.
HYDROGRAPHY BOTTOM FEATURES BOTTOM CHARACTERISTICS - COBBLES Static/Dynamic: S Symbol Set Code: 46 Code: 120608 Color: Black	<i>Cb</i>	<u>Anchor Points.</u> This graphic requires one anchor point. The center point defines the center of the graphic. <u>Size/Shape.</u> Scalable. <u>Orientation.</u> The graphic is typically centered over the desired location.
HYDROGRAPHY BOTTOM FEATURES BOTTOM CHARACTERISTICS - ROCK Static/Dynamic: S Symbol Set Code: 46 Code: 120609 Color: Black	<i>R</i>	<u>Anchor Points.</u> This graphic requires one anchor point. The center point defines the center of the graphic. <u>Size/Shape.</u> Scalable. <u>Orientation.</u> The graphic is typically centered over the desired location.

TABLE I-II. Oceanographic icons - Continued.

DESCRIPTION	ICON	DRAW RULES
HYDROGRAPHY BOTTOM FEATURES BOTTOM CHARACTERISTICS - CORAL Static/Dynamic: S Symbol Set Code: 46 Code: 120610 Color: Black	<i>Co</i>	<u>Anchor Points.</u> This graphic requires one anchor point. The center point defines the center of the graphic. <u>Size/Shape.</u> Scalable. <u>Orientation.</u> The graphic is typically centered over the desired location.
HYDROGRAPHY BOTTOM FEATURES BOTTOM CHARACTERISTICS - SHELL Static/Dynamic: S Symbol Set Code: 46 Code: 120611 Color: Black	<i>Sh</i>	<u>Anchor Points.</u> This graphic requires one anchor point. The center point defines the center of the graphic. <u>Size/Shape.</u> Scalable. <u>Orientation.</u> The graphic is typically centered over the desired location.
HYDROGRAPHY BOTTOM FEATURES QUALIFYING TERMS - FINE Static/Dynamic: S Symbol Set Code: 46 Code: 120612 Color: Black	<i>f</i>	<u>Anchor Points.</u> This graphic requires one anchor point. The center point defines the center of the graphic. <u>Size/Shape.</u> Scalable. <u>Orientation.</u> The graphic is typically centered over the desired location.
HYDROGRAPHY BOTTOM FEATURES QUALIFYING TERMS - MEDIUM Static/Dynamic: S Symbol Set Code: 46 Code: 120613 Color: Black	<i>m</i>	<u>Anchor Points.</u> This graphic requires one anchor point. The center point defines the center of the graphic. <u>Size/Shape.</u> Scalable. <u>Orientation.</u> The graphic is typically centered over the desired location.
HYDROGRAPHY BOTTOM FEATURES QUALIFYING TERMS - COARSE Static/Dynamic: S Symbol Set Code: 46 Code: 120614 Color: Black	<i>C</i>	<u>Anchor Points.</u> This graphic requires one anchor point. The center point defines the center of the graphic. <u>Size/Shape.</u> Scalable. <u>Orientation.</u> The graphic is typically centered over the desired location.

TABLE I-II. Oceanographic icons - Continued.



DESCRIPTION	ICON	DRAW RULES
<p>HYDROGRAPHY TIDE AND CURRENT</p> <p>Static/Dynamic: N/A Error! Bookmark not defined. Symbol Set Code: 46 Code: 120700</p>	<p>N/A</p>	<p>N/A</p>
<p>HYDROGRAPHY TIDE AND CURRENT</p> <p>WATER TURBULENCE</p> <p>Static/Dynamic: S Symbol Set Code: 46 Code: 120701</p> <p>Color: Gray wavy line</p>		<p><u>Anchor Points.</u> This graphic requires one anchor point. The center point defines the center of the graphic.</p> <p><u>Size/Shape.</u> Scalable.</p> <p><u>Orientation.</u> The graphic is typically centered over the desired location.</p>
<p>HYDROGRAPHY TIDE AND CURRENT</p> <p>CURRENT FLOW - EBB</p> <p>Static/Dynamic: D Symbol Set Code: 46 Code: 120702</p> <p>Color: Grey arrow w/ no feather</p>		<p><u>Anchor Points.</u> This graphic requires at least two anchor points, points 1 and 2, to define the line. Additional points can be defined to extend the line.</p> <p><u>Size/Shape.</u> Scalable/Curve.</p> <p><u>Orientation.</u> The first and last anchor points determine the length of the line. The line should be drawn in the direction of the flow.</p>
<p>HYDROGRAPHY TIDE AND CURRENT</p> <p>CURRENT FLOW - FLOOD</p> <p>Static/Dynamic: D Symbol Set Code: 46 Code: 120703</p> <p>Color: Grey arrow w/ one feather</p>		<p><u>Anchor Points.</u> This graphic requires at least two anchor points, points 1 and 2, to define the line. Additional points can be defined to extend the line.</p> <p><u>Size/Shape.</u> Scalable/Curve.</p> <p><u>Orientation.</u> The first and last anchor points determine the length of the line. The line should be drawn in the direction of the flow.</p>

TABLE I-II. Oceanographic icons - Continued.



DESCRIPTION	ICON	DRAW RULES
<p>HYDROGRAPHY TIDE AND CURRENT TIDE DATA POINT</p> <p>Static/Dynamic: S Symbol Set Code: 46 Code: 120704</p> <p>Color: Gray diamond</p>		<p><u>Anchor Points.</u> This graphic requires one anchor point. The center point defines the center of the graphic.</p> <p><u>Size/Shape.</u> Scalable.</p> <p><u>Orientation.</u> The graphic is typically centered over the desired location.</p>
<p>HYDROGRAPHY TIDE AND CURRENT TIDE GAUGE</p> <p>Static/Dynamic: S Symbol Set Code: 46 Code: 120705</p> <p>Color: Brown with Magenta</p>		<p><u>Anchor Points.</u> This graphic requires one anchor point. The center point defines the center of the graphic.</p> <p><u>Size/Shape.</u> Scalable.</p> <p><u>Orientation.</u> The graphic is typically centered over the desired location.</p>
<p>OCEANOGRAPHY</p> <p>Static/Dynamic: N/A Symbol Set Code: 46 Code: 130000</p>	<p>N/A</p>	<p>N/A</p>
<p>OCEANOGRAPHY BIOLUMINESCENCE</p> <p>Static/Dynamic: N/A Symbol Set Code: 46 Code: 130100</p>	<p>N/A</p>	<p>N/A</p>
<p>OCEANOGRAPHY BIOLUMINESCENCE VISUAL DETECTION RATIO (VDR) LEVEL 1-2</p> <p>Static/Dynamic: S Symbol Set Code: 46 Code: 130101</p> <p>Color: Dark Green (RGB 26:153:77)</p>		<p><u>Anchor Points.</u> This graphic requires at least three anchor points to define the boundary of the area. Add as many points as necessary to accurately reflect the area's size and shape.</p> <p><u>Size/Shape.</u> Determined by the anchor points.</p> <p><u>Orientation.</u> Not applicable.</p>

TABLE I-II. Oceanographic icons - Continued.



DESCRIPTION	ICON	DRAW RULES
<p>OCEANOGRAPHY BIOLUMINESCENCE VDR LEVEL 2-3</p> <p>Static/Dynamic: S Symbol Set Code: 46 Code: 130102</p> <p>Color: Light Green (RGB 26:204:77)</p>		<p><u>Anchor Points.</u> This graphic requires at least three anchor points to define the boundary of the area. Add as many points as necessary to accurately reflect the area's size and shape.</p> <p><u>Size/Shape.</u> Determined by the anchor points.</p> <p><u>Orientation.</u> Not applicable.</p>
<p>OCEANOGRAPHY BIOLUMINESCENCE VDR LEVEL 3-4</p> <p>Static/Dynamic: S Symbol Set Code: 46 Code: 130103</p> <p>Color: Lime Green RGB (128:255:51)</p>		<p><u>Anchor Points.</u> This graphic requires at least three anchor points to define the boundary of the area. Add as many points as necessary to accurately reflect the area's size and shape.</p> <p><u>Size/Shape.</u> Determined by the anchor points.</p> <p><u>Orientation.</u> Not applicable.</p>
<p>OCEANOGRAPHY BIOLUMINESCENCE VDR LEVEL 4-5</p> <p>Static/Dynamic: S Symbol Set Code: 46 Code: 130104</p> <p>Color: Yellow-Green RGB (204:255:26)</p>		<p><u>Anchor Points.</u> This graphic requires at least three anchor points to define the boundary of the area. Add as many points as necessary to accurately reflect the area's size and shape.</p> <p><u>Size/Shape.</u> Determined by the anchor points.</p> <p><u>Orientation.</u> Not applicable.</p>

TABLE I-II. Oceanographic icons - Continued.





DESCRIPTION	ICON	DRAW RULES
<p>OCEANOGRAPHY BIOLUMINESCENCE VDR LEVEL 5-6</p> <p>Static/Dynamic: S Symbol Set Code: 46 Code: 130105</p> <p>Color: Yellow RGB (255:255:0)</p>		<p><u>Anchor Points.</u> This graphic requires at least three anchor points to define the boundary of the area. Add as many points as necessary to accurately reflect the area's size and shape.</p> <p><u>Size/Shape.</u> Determined by the anchor points.</p> <p><u>Orientation.</u> Not applicable.</p>
<p>OCEANOGRAPHY BIOLUMINESCENCE VDR LEVEL 6-7</p> <p>Static/Dynamic: S Symbol Set Code: 46 Code: 130106</p> <p>Color: Gold RGB (255:204:0)</p>		<p><u>Anchor Points.</u> This graphic requires at least three anchor points to define the boundary of the area. Add as many points as necessary to accurately reflect the area's size and shape.</p> <p><u>Size/Shape.</u> Determined by the anchor points.</p> <p><u>Orientation.</u> Not applicable.</p>
<p>OCEANOGRAPHY BIOLUMINESCENCE VDR LEVEL 7-8</p> <p>Static/Dynamic: S Symbol Set Code: 46 Code: 130107</p> <p>Color: Light Orange RGB (255:128:0)</p>		<p><u>Anchor Points.</u> This graphic requires at least three anchor points to define the boundary of the area. Add as many points as necessary to accurately reflect the area's size and shape.</p> <p><u>Size/Shape.</u> Determined by the anchor points.</p> <p><u>Orientation.</u> Not applicable.</p>
<p>OCEANOGRAPHY BIOLUMINESCENCE VDR LEVEL 8-9</p> <p>Static/Dynamic: S Symbol Set Code: 46 Code: 130108</p> <p>Color: Dark Orange RGB (255:77:0)</p>		<p><u>Anchor Points.</u> This graphic requires at least three anchor points to define the boundary of the area. Add as many points as necessary to accurately reflect the area's size and shape.</p> <p><u>Size/Shape.</u> Determined by the anchor points.</p> <p><u>Orientation.</u> Not applicable.</p>

TABLE I-II. Oceanographic icons - Continued.

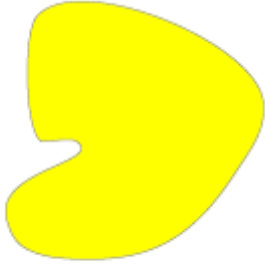

DESCRIPTION	ICON	DRAW RULES
<p>OCEANOGRAPHY BIOLUMINESCENCE VDR LEVEL 9-10</p> <p>Static/Dynamic: S Symbol Set Code: 46 Code: 130109</p> <p>Color: Red RGB (255:0:0)</p>		<p><u>Anchor Points.</u> This graphic requires at least three anchor points to define the boundary of the area. Add as many points as necessary to accurately reflect the area's size and shape.</p> <p><u>Size/Shape.</u> Determined by the anchor points.</p> <p><u>Orientation.</u> Not applicable.</p>
<p>OCEANOGRAPHY BEACH SLOPE</p> <p>Static/Dynamic: N/A Symbol Set Code: 46 Code: 130200</p>	<p>N/A</p>	<p>N/A</p>
<p>OCEANOGRAPHY BEACH SLOPE FLAT</p> <p>Static/Dynamic: S Symbol Set Code: 46 Code: 130201</p> <p>Color: Light Gray</p>		<p><u>Anchor Points.</u> This graphic requires at least three anchor points to define the boundary of the area. Add as many points as necessary to accurately reflect the area's size and shape.</p> <p><u>Size/Shape.</u> Determined by the anchor points.</p> <p><u>Orientation.</u> Not applicable.</p>
<p>OCEANOGRAPHY BEACH SLOPE GENTLE</p> <p>Static/Dynamic: S Symbol Set Code: 46 Code: 130202</p> <p>Color: Dark Grey</p>		<p><u>Anchor Points.</u> This graphic requires at least three anchor points to define the boundary of the area. Add as many points as necessary to accurately reflect the area's size and shape.</p> <p><u>Size/Shape.</u> Determined by the anchor points.</p> <p><u>Orientation.</u> Not applicable.</p>

TABLE I-II. Oceanographic icons - Continued.



DESCRIPTION	ICON	DRAW RULES
<p>OCEANOGRAPHY BEACH SLOPE MODERATE</p> <p>Static/Dynamic: S Symbol Set Code: 46 Code: 130203</p> <p>Color: Light Gray</p> <p>Light Gray Dot Fill with Gray Outline</p>		<p><u>Anchor Points.</u> This graphic requires at least three anchor points to define the boundary of the area. Add as many points as necessary to accurately reflect the area's size and shape.</p> <p><u>Size/Shape.</u> Determined by the anchor points.</p> <p><u>Orientation.</u> Not applicable.</p>
<p>OCEANOGRAPHY BEACH SLOPE STEEP</p> <p>Static/Dynamic: S Symbol Set Code: 46 Code: 130204</p> <p>Color: Dark Gray</p> <p>Dark Gray Dot Fill w/ Gray Outline</p>		<p><u>Anchor Points.</u> This graphic requires at least three anchor points to define the boundary of the area. Add as many points as necessary to accurately reflect the area's size and shape.</p> <p><u>Size/Shape.</u> Determined by the anchor points.</p> <p><u>Orientation.</u> Not applicable.</p>
<p>GEOPHYSICS/ACOUSTICS</p> <p>Static/Dynamic: N/A Symbol Set Code: 46 Code: 140000</p>	<p>N/A</p>	<p>N/A</p>
<p>GEOPHYSICS/ACOUSTICS MINE WARFARE (MIW) BOTTOM DESCRIPTORS</p> <p>Static/Dynamic: N/A Symbol Set Code: 46 Code: 140100</p>	<p>N/A</p>	<p>N/A</p>
<p>GEOPHYSICS/ACOUSTICS MINE WARFARE BOTTOM DESCRIPTORS BOTTOM SEDIMENTS - SOLID ROCK</p> <p>Static/Dynamic: S Symbol Set Code: 46 Code: 140101</p> <p>Color: Purple (RGB 255:0:255)</p>		<p><u>Anchor Points.</u> This graphic requires at least three anchor points to define the boundary of the area. Add as many points as necessary to accurately reflect the area's size and shape.</p> <p><u>Size/Shape.</u> Determined by the anchor points.</p> <p><u>Orientation.</u> Not applicable.</p>

TABLE I-II. Oceanographic icons - Continued.

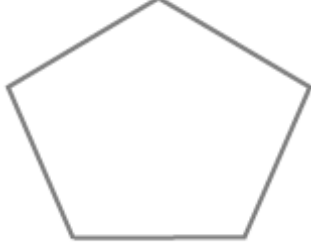

DESCRIPTION	ICON	DRAW RULES
<p>GEOPHYSICS/ACOUSTICS MINE WARFARE BOTTOM DESCRIPTORS MIW-BOTTOM SEDIMENTS - CLAY</p> <p>Static/Dynamic: S Symbol Set Code: 46 Code: 140102</p> <p>Color: Periwinkle (RGB 100:130:255)</p>		<p><u>Anchor Points.</u> This graphic requires at least three anchor points to define the boundary of the area. Add as many points as necessary to accurately reflect the area's size and shape.</p> <p><u>Size/Shape.</u> Determined by the anchor points.</p> <p><u>Orientation.</u> Not applicable.</p>
<p>GEOPHYSICS/ACOUSTICS MINE WARFARE BOTTOM DESCRIPTORS MIW-BOTTOM SEDIMENTS - VERY COARSE SAND</p> <p>Static/Dynamic: S Symbol Set Code: 46 Code: 140103</p> <p>Color: Gold (RGB 255:180:0)</p>		<p><u>Anchor Points.</u> This graphic requires at least three anchor points to define the boundary of the area. Add as many points as necessary to accurately reflect the area's size and shape.</p> <p><u>Size/Shape.</u> Determined by the anchor points.</p> <p><u>Orientation.</u> Not applicable.</p>
<p>GEOPHYSICS/ACOUSTICS MINE WARFARE BOTTOM DESCRIPTORS MIW-BOTTOM SEDIMENTS - COARSE SAND</p> <p>Static/Dynamic: S Symbol Set Code: 46 Code: 140104</p> <p>Color: Light Gold (RGB 255:215:0)</p>		<p><u>Anchor Points.</u> This graphic requires at least three anchor points to define the boundary of the area. Add as many points as necessary to accurately reflect the area's size and shape.</p> <p><u>Size/Shape.</u> Determined by the anchor points.</p> <p><u>Orientation.</u> Not applicable.</p>
<p>GEOPHYSICS/ACOUSTICS MINE WARFARE BOTTOM DESCRIPTORS MIW-BOTTOM SEDIMENTS - MEDIUM SAND</p> <p>Static/Dynamic: S Symbol Set Code: 46 Code: 140105</p> <p>Color: Yellow (RGB 255:235:0)</p>		<p><u>Anchor Points.</u> This graphic requires at least three anchor points to define the boundary of the area. Add as many points as necessary to accurately reflect the area's size and shape.</p> <p><u>Size/Shape.</u> Determined by the anchor points.</p> <p><u>Orientation.</u> Not applicable.</p>

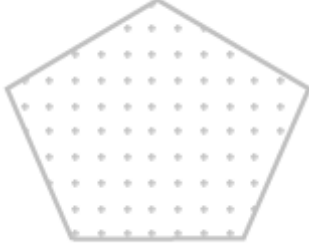
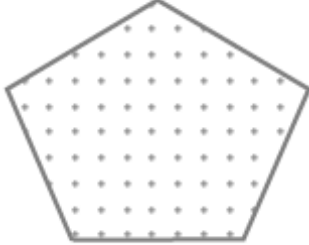
TABLE I-II. Oceanographic icons - Continued.



DESCRIPTION	ICON	DRAW RULES
<p>GEOPHYSICS/ACOUSTICS MINE WARFARE BOTTOM DESCRIPTORS MIW-BOTTOM SEDIMENTS - FINE SAND</p> <p>Static/Dynamic: S Symbol Set Code: 46 Code: 140106</p> <p>Color: Light Yellow (RGB 255:255:140)</p>		<p><u>Anchor Points.</u> This graphic requires at least three anchor points to define the boundary of the area. Add as many points as necessary to accurately reflect the area's size and shape.</p> <p><u>Size/Shape.</u> Determined by the anchor points.</p> <p><u>Orientation.</u> Not applicable.</p>
<p>GEOPHYSICS/ACOUSTICS MINE WARFARE BOTTOM DESCRIPTORS MIW-BOTTOM SEDIMENTS - VERY FINE SAND</p> <p>Static/Dynamic: S Symbol Set Code: 46 Code: 140107</p> <p>Color: Pale Yellow (RGB 255:255:220)</p>		<p><u>Anchor Points.</u> This graphic requires at least three anchor points to define the boundary of the area. Add as many points as necessary to accurately reflect the area's size and shape.</p> <p><u>Size/Shape.</u> Determined by the anchor points.</p> <p><u>Orientation.</u> Not applicable.</p>
<p>GEOPHYSICS/ACOUSTICS MINEWARFARE BOTTOM DESCRIPTORS MIW-BOTTOM SEDIMENTS - VERY FINE SILT</p> <p>Static/Dynamic: S Symbol Set Code: 46 Code: 140108</p> <p>Color: Turquoise (RGB 0:215:255)</p>		<p><u>Anchor Points.</u> This graphic requires at least three anchor points to define the boundary of the area. Add as many points as necessary to accurately reflect the area's size and shape.</p> <p><u>Size/Shape.</u> Determined by the anchor points.</p> <p><u>Orientation.</u> Not applicable.</p>
<p>GEOPHYSICS/ACOUSTICS MINE WARFARE BOTTOM DESCRIPTORS MIW-BOTTOM SEDIMENTS - FINE SILT</p> <p>Static/Dynamic: S Symbol Set Code: 46 Code: 140109</p> <p>Color: Aquamarine (RGB 25:255:230)</p>		<p><u>Anchor Points.</u> This graphic requires at least three anchor points to define the boundary of the area. Add as many points as necessary to accurately reflect the area's size and shape.</p> <p><u>Size/Shape.</u> Determined by the anchor points.</p> <p><u>Orientation.</u> Not applicable.</p>

TABLE I-II. Oceanographic icons - Continued.

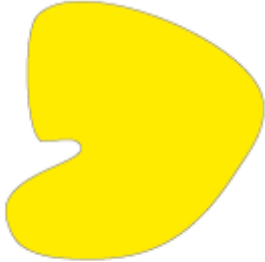

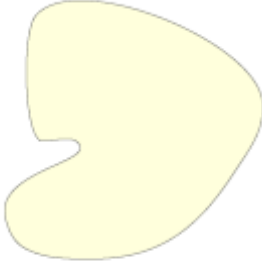

DESCRIPTION	ICON	DRAW RULES
<p>GEOPHYSICS/ACOUSTICS MINE WARFARE BOTTOM DESCRIPTORS MIW-BOTTOM SEDIMENTS - MEDIUM SILT</p> <p>Static/Dynamic: S Symbol Set Code: 46 Code: 140110</p> <p>Color: Green (RGB 0:255:0)</p>		<p><u>Anchor Points.</u> This graphic requires at least three anchor points to define the boundary of the area. Add as many points as necessary to accurately reflect the area's size and shape.</p> <p><u>Size/Shape.</u> Determined by the anchor points.</p> <p><u>Orientation.</u> Not applicable.</p>
<p>GEOPHYSICS/ACOUSTICS MINE WARFARE BOTTOM DESCRIPTORS MIW-BOTTOM SEDIMENTS - COARSE SILT</p> <p>Static/Dynamic: S Symbol Set Code: 46 Code: 140111</p> <p>Color: Lime Green (RGB 200:255:105)</p>		<p><u>Anchor Points.</u> This graphic requires at least three anchor points to define the boundary of the area. Add as many points as necessary to accurately reflect the area's size and shape.</p> <p><u>Size/Shape.</u> Determined by the anchor points.</p> <p><u>Orientation.</u> Not applicable.</p>
<p>GEOPHYSICS/ACOUSTICS MINE WARFARE BOTTOM DESCRIPTORS MIW-BOTTOM SEDIMENTS - BOULDERS</p> <p>Static/Dynamic: S Symbol Set Code: 46 Code: 140112</p> <p>Color: Red (RGB 255:0:0)</p>		<p><u>Anchor Points.</u> This graphic requires at least three anchor points to define the boundary of the area. Add as many points as necessary to accurately reflect the area's size and shape.</p> <p><u>Size/Shape.</u> Determined by the anchor points.</p> <p><u>Orientation.</u> Not applicable.</p>
<p>GEOPHYSICS/ACOUSTICS MINE WARFARE BOTTOM DESCRIPTORS MIW-BOTTOM SEDIMENTS - COBBLES, OYSTER SHELLS</p> <p>Static/Dynamic: S Symbol Set Code: 46 Code: 140113</p> <p>Color: Dark Peach (RGB 255:150:150)</p>		<p><u>Anchor Points.</u> This graphic requires at least three anchor points to define the boundary of the area. Add as many points as necessary to accurately reflect the area's size and shape.</p> <p><u>Size/Shape.</u> Determined by the anchor points.</p> <p><u>Orientation.</u> Not applicable.</p>

TABLE I-II. Oceanographic icons - Continued.



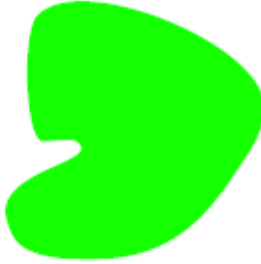

DESCRIPTION	ICON	DRAW RULES
<p>GEOPHYSICS/ACOUSTICS MINE WARFARE BOTTOM DESCRIPTORS MIW-BOTTOM SEDIMENTS - PEBBLES, SHELLS</p> <p>Static/Dynamic: S Symbol Set Code: 46 Code: 140114</p> <p>Color: Peach (RGB 255:190:190)</p>		<p><u>Anchor Points.</u> This graphic requires at least three anchor points to define the boundary of the area. Add as many points as necessary to accurately reflect the area's size and shape.</p> <p><u>Size/Shape.</u> Determined by the anchor points.</p> <p><u>Orientation.</u> Not applicable.</p>
<p>GEOPHYSICS/ACOUSTICS MINE WARFARE BOTTOM DESCRIPTORS MIW-BOTTOM SEDIMENTS - SAND AND SHELLS</p> <p>Static/Dynamic: S Symbol Set Code: 46 Code: 140115</p> <p>Color: Light Peach (RGB 255:220:220)</p>		<p><u>Anchor Points.</u> This graphic requires at least three anchor points to define the boundary of the area. Add as many points as necessary to accurately reflect the area's size and shape.</p> <p><u>Size/Shape.</u> Determined by the anchor points.</p> <p><u>Orientation.</u> Not applicable.</p>
<p>GEOPHYSICS/ACOUSTICS MINE WARFARE BOTTOM DESCRIPTORS MIW-BOTTOM SEDIMENTS - LAND</p> <p>Static/Dynamic: S Symbol Set Code: 46 Code: 140116</p> <p>Color: Grey (RGB 220:220:220)</p>		<p><u>Anchor Points.</u> This graphic requires at least three anchor points to define the boundary of the area. Add as many points as necessary to accurately reflect the area's size and shape.</p> <p><u>Size/Shape.</u> Determined by the anchor points.</p> <p><u>Orientation.</u> Not applicable.</p>
<p>GEOPHYSICS/ACOUSTICS MINE WARFARE BOTTOM DESCRIPTORS MIW-BOTTOM SEDIMENTS - NO DATA</p> <p>Static/Dynamic: S Symbol Set Code: 46 Code: 140117</p> <p>Color: Light Grey (RGB 230:230:230)</p>		<p><u>Anchor Points.</u> This graphic requires at least three anchor points to define the boundary of the area. Add as many points as necessary to accurately reflect the area's size and shape.</p> <p><u>Size/Shape.</u> Determined by the anchor points.</p> <p><u>Orientation.</u> Not applicable.</p>

TABLE I-II. Oceanographic icons - Continued.



DESCRIPTION	ICON	DRAW RULES
<p>GEOPHYSICS/ACOUSTICS MINE WARFARE BOTTOM DESCRIPTORS BOTTOM ROUGHNESS - SMOOTH</p> <p>Static/Dynamic: S Symbol Set Code: 46 Code: 140118</p> <p>Color: Green (RGB 0:255:0)</p>		<p><u>Anchor Points.</u> This graphic requires at least three anchor points to define the boundary of the area. Add as many points as necessary to accurately reflect the area's size and shape.</p> <p><u>Size/Shape.</u> Determined by the anchor points.</p> <p><u>Orientation.</u> Not applicable.</p>
<p>GEOPHYSICS/ACOUSTICS MINE WARFARE BOTTOM DESCRIPTORS BOTTOM ROUGHNESS - MODERATE</p> <p>Static/Dynamic: S Symbol Set Code: 46 Code: 140119</p> <p>Color: Yellow (RGB 255:255:0)</p>		<p><u>Anchor Points.</u> This graphic requires at least three anchor points to define the boundary of the area. Add as many points as necessary to accurately reflect the area's size and shape.</p> <p><u>Size/Shape.</u> Determined by the anchor points.</p> <p><u>Orientation.</u> Not applicable.</p>
<p>GEOPHYSICS/ACOUSTICS MINE WARFARE BOTTOM DESCRIPTORS BOTTOM ROUGHNESS - ROUGH</p> <p>Static/Dynamic: S Symbol Set Code: 46 Code: 140120</p> <p>Color: Red (RGB 0:255:0)</p>		<p><u>Anchor Points.</u> This graphic requires at least three anchor points to define the boundary of the area. Add as many points as necessary to accurately reflect the area's size and shape.</p> <p><u>Size/Shape.</u> Determined by the anchor points.</p> <p><u>Orientation.</u> Not applicable.</p>
<p>GEOPHYSICS/ACOUSTICS MINE WARFARE BOTTOM DESCRIPTORS CLUTTER (BOTTOM) - LOW</p> <p>Static/Dynamic: S Symbol Set Code: 46 Code: 140121</p> <p>Color: Green (RGB 255:255:0)</p>		<p><u>Anchor Points.</u> This graphic requires at least three anchor points to define the boundary of the area. Add as many points as necessary to accurately reflect the area's size and shape.</p> <p><u>Size/Shape.</u> Determined by the anchor points.</p> <p><u>Orientation.</u> Not applicable.</p>

TABLE I-II. Oceanographic icons - Continued.



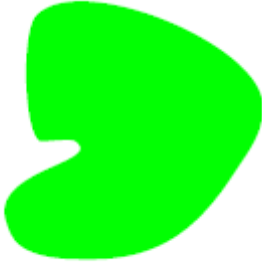
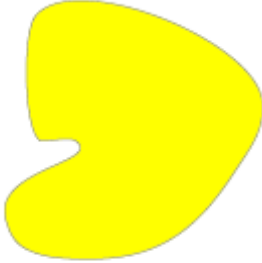

DESCRIPTION	ICON	DRAW RULES
<p>GEOPHYSICS/ACOUSTICS MINE WARFARE BOTTOM DESCRIPTORS CLUTTER (BOTTOM) - MEDIUM</p> <p>Static/Dynamic: S Symbol Set Code: 46 Code: 140122</p> <p>Color: Yellow (RGB 255:255:0)</p>		<p><u>Anchor Points.</u> This graphic requires at least three anchor points to define the boundary of the area. Add as many points as necessary to accurately reflect the area's size and shape.</p> <p><u>Size/Shape.</u> Determined by the anchor points.</p> <p><u>Orientation.</u> Not applicable.</p>
<p>GEOPHYSICS/ACOUSTICS MINE WARFARE BOTTOM DESCRIPTORS CLUTTER (BOTTOM) - HIGH</p> <p>Static/Dynamic: S Symbol Set Code: 46 Code: 140123</p> <p>Color: Red (RGB 255:0:0)</p>		<p><u>Anchor Points.</u> This graphic requires at least three anchor points to define the boundary of the area. Add as many points as necessary to accurately reflect the area's size and shape.</p> <p><u>Size/Shape.</u> Determined by the anchor points.</p> <p><u>Orientation.</u> Not applicable.</p>
<p>GEOPHYSICS/ACOUSTICS MINE WARFARE BOTTOM DESCRIPTORS IMPACT BURIAL - 0%</p> <p>Static/Dynamic: S Symbol Set Code: 46 Code: 140124</p> <p>Color: Blue RGB (0:0:255)</p>		<p><u>Anchor Points.</u> This graphic requires at least three anchor points to define the boundary of the area. Add as many points as necessary to accurately reflect the area's size and shape.</p> <p><u>Size/Shape.</u> Determined by the anchor points.</p> <p><u>Orientation.</u> Not applicable.</p>
<p>GEOPHYSICS/ACOUSTICS MINE WARFARE BOTTOM DESCRIPTORS IMPACT BURIAL - 0-10%</p> <p>Static/Dynamic: S Symbol Set Code: 46 Code: 140125</p> <p>Color: Green RGB (0:255:0)</p>		<p><u>Anchor Points.</u> This graphic requires at least three anchor points to define the boundary of the area. Add as many points as necessary to accurately reflect the area's size and shape.</p> <p><u>Size/Shape.</u> Determined by the anchor points.</p> <p><u>Orientation.</u> Not applicable.</p>

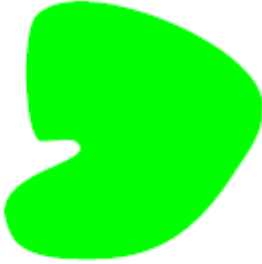
TABLE I-II. Oceanographic icons - Continued.

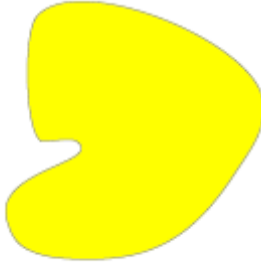

DESCRIPTION	ICON	DRAW RULES
<p>GEOPHYSICS/ACOUSTICS MINEWARFARE BOTTOM DESCRIPTORS IMPACT BURIAL - 10-20%</p> <p>Static/Dynamic: S Symbol Set Code: 46 Code: 140126</p> <p>Color: Yellow (RGB 255:255:0)</p>		<p><u>Anchor Points.</u> This graphic requires at least three anchor points to define the boundary of the area. Add as many points as necessary to accurately reflect the area's size and shape.</p> <p><u>Size/Shape.</u> Determined by the anchor points.</p> <p><u>Orientation.</u> Not applicable.</p>
<p>GEOPHYSICS/ACOUSTICS MINE WARFARE BOTTOM DESCRIPTORS IMPACT BURIAL - 20-75%</p> <p>Static/Dynamic: S Symbol Set Code: 46 Code: 140127</p> <p>Color: Orange (RGB 255:127:0)</p>		<p><u>Anchor Points.</u> This graphic requires at least three anchor points to define the boundary of the area. Add as many points as necessary to accurately reflect the area's size and shape.</p> <p><u>Size/Shape.</u> Determined by the anchor points.</p> <p><u>Orientation.</u> Not applicable.</p>
<p>GEOPHYSICS/ACOUSTICS MINE WARFARE BOTTOM DESCRIPTORS IMPACT BURIAL - >75%</p> <p>Static/Dynamic: S Symbol Set Code: 46 Code: 140128</p> <p>Color: Red (RGB 255:0:00)</p>		<p><u>Anchor Points.</u> This graphic requires at least three anchor points to define the boundary of the area. Add as many points as necessary to accurately reflect the area's size and shape.</p> <p><u>Size/Shape.</u> Determined by the anchor points.</p> <p><u>Orientation.</u> Not applicable.</p>
<p>GEOPHYSICS/ACOUSTICS MINE WARFARE BOTTOM DESCRIPTORS MIW BOTTOM CATEGORY - A</p> <p>Static/Dynamic: S Symbol Set Code: 46 Code: 140129</p> <p>Color: Green (RGB 0:255:0)</p>		<p><u>Anchor Points.</u> This graphic requires at least three anchor points to define the boundary of the area. Add as many points as necessary to accurately reflect the area's size and shape.</p> <p><u>Size/Shape.</u> Determined by the anchor points.</p> <p><u>Orientation.</u> Not applicable.</p>

TABLE I-II. Oceanographic icons - Continued.



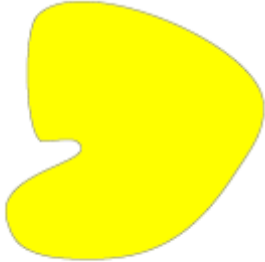

DESCRIPTION	ICON	DRAW RULES
<p>GEOPHYSICS/ACOUSTICS MINE WARFARE BOTTOM DESCRIPTORS MIW BOTTOM CATEGORY - B</p> <p>Static/Dynamic: S Symbol Set Code: 46 Code: 140130</p> <p>Color: Yellow (RGB 255:255:0)</p>		<p><u>Anchor Points.</u> This graphic requires at least three anchor points to define the boundary of the area. Add as many points as necessary to accurately reflect the area's size and shape.</p> <p><u>Size/Shape.</u> Determined by the anchor points.</p> <p><u>Orientation.</u> Not applicable.</p>
<p>GEOPHYSICS/ACOUSTICS MINE WARFARE BOTTOM DESCRIPTORS MIW BOTTOM CATEGORY - C</p> <p>Static/Dynamic: S Symbol Set Code: 46 Code: 140131</p> <p>Color: Red (RGB 255:0:0)</p>		<p><u>Anchor Points.</u> This graphic requires at least three anchor points to define the boundary of the area. Add as many points as necessary to accurately reflect the area's size and shape.</p> <p><u>Size/Shape.</u> Determined by the anchor points.</p> <p><u>Orientation.</u> Not applicable.</p>
<p>GEOPHYSICS/ACOUSTICS MINE WARFARE BOTTOM DESCRIPTORS MIW BOTTOM TYPE - A1</p> <p>Static/Dynamic: S Symbol Set Code: 46 Code: 140132</p> <p>Color: Green (RGB 48:255:0)</p>		<p><u>Anchor Points.</u> This graphic requires at least three anchor points to define the boundary of the area. Add as many points as necessary to accurately reflect the area's size and shape.</p> <p><u>Size/Shape.</u> Determined by the anchor points.</p> <p><u>Orientation.</u> Not applicable.</p>
<p>GEOPHYSICS/ACOUSTICS MINE WARFARE BOTTOM DESCRIPTORS MIW BOTTOM TYPE - A2</p> <p>Static/Dynamic: S Symbol Set Code: 46 Code: 140133</p> <p>Color: Light Green (RGB 127:255:0)</p>		<p><u>Anchor Points.</u> This graphic requires at least three anchor points to define the boundary of the area. Add as many points as necessary to accurately reflect the area's size and shape.</p> <p><u>Size/Shape.</u> Determined by the anchor points.</p> <p><u>Orientation.</u> Not applicable..</p>

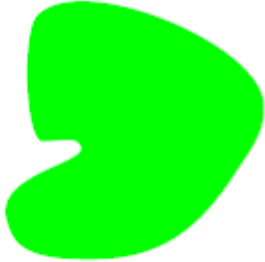
TABLE I-II. Oceanographic icons - Continued.

DESCRIPTION	ICON	DRAW RULES
<p>GEOPHYSICS/ACOUSTICS MINE WARFARE BOTTOM DESCRIPTORS MIW BOTTOM TYPE - A3</p> <p>Static/Dynamic: S Symbol Set Code: 46 Code: 140134</p> <p>Color: Lime Green (RGB 175:255:0)</p>		<p><u>Anchor Points.</u> This graphic requires at least three anchor points to define the boundary of the area. Add as many points as necessary to accurately reflect the area's size and shape.</p> <p><u>Size/Shape.</u> Determined by the anchor points.</p> <p><u>Orientation.</u> Not applicable.</p>
<p>GEOPHYSICS/ACOUSTICS MINE WARFARE BOTTOM DESCRIPTORS MIW BOTTOM TYPE - B1</p> <p>Static/Dynamic: S Symbol Set Code: 46 Code: 140135</p> <p>Color: Yellow-Green (RGB 207:255:0)</p>		<p><u>Anchor Points.</u> This graphic requires at least three anchor points to define the boundary of the area. Add as many points as necessary to accurately reflect the area's size and shape.</p> <p><u>Size/Shape.</u> Determined by the anchor points.</p> <p><u>Orientation.</u> Not applicable.</p>
<p>GEOPHYSICS/ACOUSTICS MINE WARFARE BOTTOM DESCRIPTORS MIW BOTTOM TYPE - B2</p> <p>Static/Dynamic: S Symbol Set Code: 46 Code: 1401436</p> <p>Color: Yellow (RGB 255:255:0)</p>		<p><u>Anchor Points.</u> This graphic requires at least three anchor points to define the boundary of the area. Add as many points as necessary to accurately reflect the area's size and shape.</p> <p><u>Size/Shape.</u> Determined by the anchor points.</p> <p><u>Orientation.</u> Not applicable.</p>
<p>GEOPHYSICS/ACOUSTICS MINE WARFARE BOTTOM DESCRIPTORS MIW BOTTOM TYPE - B3</p> <p>Static/Dynamic: S Symbol Set Code: 46 Code: 140137</p> <p>Color: Gold (RGB 255:207:0)</p>		<p><u>Anchor Points.</u> This graphic requires at least three anchor points to define the boundary of the area. Add as many points as necessary to accurately reflect the area's size and shape.</p> <p><u>Size/Shape.</u> Determined by the anchor points.</p> <p><u>Orientation.</u> Not applicable.</p>

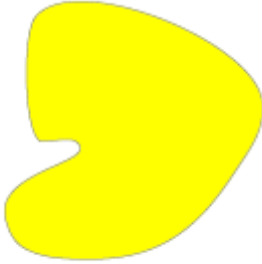
TABLE I-II. Oceanographic icons - Continued.

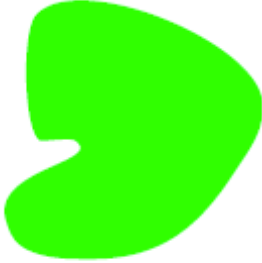

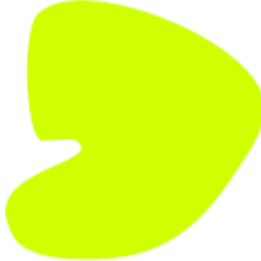
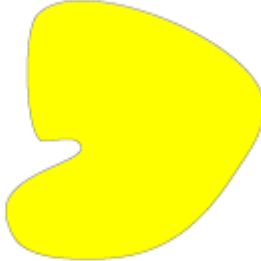

DESCRIPTION	ICON	DRAW RULES
<p>GEOPHYSICS/ACOUSTICS MINE WARFARE BOTTOM DESCRIPTORS MIW BOTTOM TYPE - C1</p> <p>Static/Dynamic: S Symbol Set Code: 46 Code: 140138</p> <p>Color: Orange (RGB 255:127:0)</p>		<p><u>Anchor Points.</u> This graphic requires at least three anchor points to define the boundary of the area. Add as many points as necessary to accurately reflect the area's size and shape.</p> <p><u>Size/Shape.</u> Determined by the anchor points.</p> <p><u>Orientation.</u> Not applicable.</p>
<p>GEOPHYSICS/ACOUSTICS MINE WARFARE BOTTOM DESCRIPTORS MIW BOTTOM TYPE - C2</p> <p>Static/Dynamic: S Symbol Set Code: 46 Code: 140139</p> <p>Color: Dark Orange (RGB 255:80:0)</p>		<p><u>Anchor Points.</u> This graphic requires at least three anchor points to define the boundary of the area. Add as many points as necessary to accurately reflect the area's size and shape.</p> <p><u>Size/Shape.</u> Determined by the anchor points.</p> <p><u>Orientation.</u> Not applicable.</p>
<p>GEOPHYSICS/ACOUSTICS MINE WARFARE BOTTOM DESCRIPTORS MIW BOTTOM TYPE - C3</p> <p>Static/Dynamic: S Symbol Set Code: 46 Code: 140140</p> <p>Color: Orange-Red (RGB 255:48:0)</p>		<p><u>Anchor Points.</u> This graphic requires at least three anchor points to define the boundary of the area. Add as many points as necessary to accurately reflect the area's size and shape.</p> <p><u>Size/Shape.</u> Determined by the anchor points.</p> <p><u>Orientation.</u> Not applicable.</p>
<p>LIMITS</p> <p>Static/Dynamic: N/A Symbol Set Code: 46 Code: 150000</p>	<p>N/A</p>	<p>N/A</p>
<p>LIMITS MARITIME LIMIT BOUNDARY</p> <p>Static/Dynamic: S Symbol Set Code: 46 Code: 150100</p> <p>Color: Magenta thin short dash line</p>		<p><u>Anchor Points.</u> This graphic requires at least two anchor points, points 1 and 2, to define the line. Additional points can be defined to extend the line.</p> <p><u>Size/Shape.</u> Scalable.</p> <p><u>Orientation.</u> The first and last anchor points determine the length of the line.</p>

TABLE I-II. Oceanographic icons - Continued.





DESCRIPTION	ICON	DRAW RULES
<p>LIMITS MARITIME AREA</p> <p>Static/Dynamic: S Symbol Set Code: 46 Code: 150200</p> <p>Color: Magenta</p>		<p><u>Anchor Points.</u> This graphic requires at least three anchor points to define the boundary of the area. Add as many points as necessary to accurately reflect the area's size and shape.</p> <p><u>Size/Shape.</u> Determined by the anchor points.</p> <p><u>Orientation.</u> Not applicable.</p>
<p>LIMITS RESTRICTED AREA</p> <p>Static/Dynamic: S Symbol Set Code: 46 Code: 150300</p> <p>Color: Magenta dashed T line</p>		<p><u>Anchor Points.</u> This graphic requires at least two anchor points, points 1 and 2, to define the line. Additional points can be defined to extend the line.</p> <p><u>Size/Shape.</u> Scalable.</p> <p><u>Orientation.</u> The first and last anchor points determine the length of the line.</p>
<p>LIMITS SWEPT AREA</p> <p>Static/Dynamic: S Symbol Set Code: 46 Code: 150400</p> <p>Color: Pink dots</p>		<p><u>Anchor Points.</u> This graphic requires at least three anchor points to define the boundary of the area. Add as many points as necessary to accurately reflect the area's size and shape.</p> <p><u>Size/Shape.</u> Determined by the anchor points.</p> <p><u>Orientation.</u> Not applicable.</p>
<p>LIMITS TRAINING AREA</p> <p>Static/Dynamic: S Symbol Set Code: 46 Code: 150500</p> <p>Color: Magenta</p> <p>Magenta ! in circle w/ dashed outline</p>		<p><u>Anchor Points.</u> This graphic requires at least three anchor points to define the boundary of the area. Add as many points as necessary to accurately reflect the area's size and shape.</p> <p><u>Size/Shape.</u> Determined by the anchor points.</p> <p><u>Orientation.</u> Not applicable.</p>

TABLE I-II. Oceanographic icons - Continued.

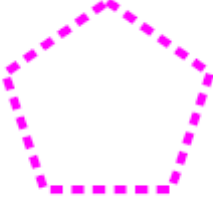

DESCRIPTION	ICON	DRAW RULES
<p>LIMITS OPERATOR-DEFINED</p> <p>Static/Dynamic: S Symbol Set Code: 46 Code: 150600</p> <p>Color: Orange solid outline</p>		<p><u>Anchor Points.</u> This graphic requires at least three anchor points to define the boundary of the area. Add as many points as necessary to accurately reflect the area's size and shape.</p> <p><u>Size/Shape.</u> Determined by the anchor points.</p> <p><u>Orientation.</u> Not applicable.</p>
<p>MAN-MADE STRUCTURES</p> <p>Static/Dynamic: N/A Symbol Set Code: 46 Code: 160000</p>	<p>N/A</p>	<p>N/A</p>
<p>MAN-MADE STRUCTURES SUBMARINE CABLE</p> <p>Static/Dynamic: S Symbol Set Code: 46 Code: 160100</p> <p>Color: Magenta Line Style: Repeating pattern wavy lines</p>		<p><u>Anchor Points.</u> This graphic requires at least two anchor points, points 1 and 2, to define the line. Additional points can be defined to extend the line.</p> <p><u>Size/Shape.</u> Scalable. The points are typically connected with a solid curved lined. The curvature of the lines is operator defined.</p> <p><u>Orientation.</u> The first and last anchor points determine the length of the line.</p>
<p>MAN-MADE STRUCTURES SUBMERGED CRIB</p> <p>Static/Dynamic: S Symbol Set Code: 46 Code: 160200</p> <p>Color: Blue/Black Blue fill w/ black dotted outline</p>		<p><u>Anchor Points.</u> This graphic requires at least three anchor points to define the boundary of the area. Add as many points as necessary to accurately reflect the area's size and shape.</p> <p><u>Size/Shape.</u> Determined by the anchor points.</p> <p><u>Orientation.</u> Not applicable.</p>

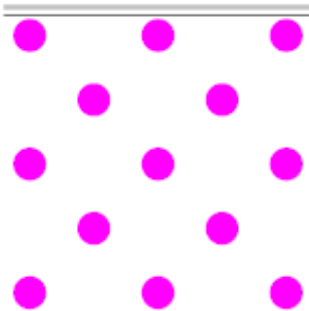
TABLE I-II. Oceanographic icons - Continued.



DESCRIPTION	ICON	DRAW RULES
<p>MAN-MADE STRUCTURES CANAL</p> <p>Static/Dynamic: D Symbol Set Code: 46 Code: 160300</p> <p>Color: Black solid thick line</p>		<p><u>Anchor Points.</u> This graphic requires at least two anchor points, points 1 and 2, to define the line. Additional points can be defined to extend the line.</p> <p><u>Size/Shape.</u> Scalable.</p> <p><u>Orientation.</u> The first and last anchor points determine the length of the line.</p>
<p>MAN-MADE STRUCTURES FORD</p> <p>Static/Dynamic: S Symbol Set Code: 46 Code: 160400</p> <p>Color: Black symbol</p>		<p><u>Anchor Points.</u> This graphic requires one anchor point. The center point defines the center of the graphic.</p> <p><u>Size/Shape.</u> Scalable.</p> <p><u>Orientation.</u> The graphic is typically centered over the desired location.</p>
<p>MAN-MADE STRUCTURES LOCK</p> <p>Static/Dynamic: S Symbol Set Code: 46 Code: 160500</p> <p>Color: Black symbol</p>		<p><u>Anchor Points.</u> This graphic requires one anchor point. The center point defines the center of the graphic.</p> <p><u>Size/Shape.</u> Scalable.</p> <p><u>Orientation.</u> The graphic is typically centered over the desired location.</p>
<p>MAN-MADE STRUCTURES OIL/GAS RIG</p> <p>Static/Dynamic: S Symbol Set Code: 46 Code: 160600</p> <p>Color: Black symbol</p>		<p><u>Anchor Points.</u> This graphic requires one anchor point. The center point defines the center of the graphic.</p> <p><u>Size/Shape.</u> Scalable.</p> <p><u>Orientation.</u> The graphic is typically centered over the desired location.</p>

TABLE I-II. Oceanographic icons - Continued.



DESCRIPTION	ICON	DRAW RULES
<p>MAN-MADE STRUCTURES OIL/GAS RIG FIELD</p> <p>Static/Dynamic: S Symbol Set Code: 46 Code: 160700</p> <p>Color: Gray dot pattern fill</p>		<p><u>Anchor Points.</u> This graphic requires at least three anchor points to define the boundary of the area. Add as many points as necessary to accurately reflect the area's size and shape.</p> <p><u>Size/Shape.</u> Determined by the anchor points.</p> <p><u>Orientation.</u> Not applicable.</p>
<p>MAN-MADE STRUCTURES PIPELINES/PIPE</p> <p>Static/Dynamic: S Symbol Set Code: 46 Code: 160800</p> <p>Color: Gray dash line with circle</p>		<p><u>Anchor Points.</u> This graphic requires at least two anchor points, points 1 and 2, to define the line. Additional points can be defined to extend the line.</p> <p><u>Size/Shape.</u> Scalable.</p> <p><u>Orientation.</u> The first and last anchor points determine the length of the line.</p>
<p>MAN-MADE STRUCTURES PILE/PILING/POST</p> <p>Static/Dynamic: S Symbol Set Code: 46 Code: 160900</p> <p>Color: Black dot</p>		<p><u>Anchor Points.</u> This graphic requires one anchor point. The center point defines the center of the graphic.</p> <p><u>Size/Shape.</u> Scalable.</p> <p><u>Orientation.</u> The graphic is typically centered over the desired location.</p>

TABLE I-III. Meteorological space icons.

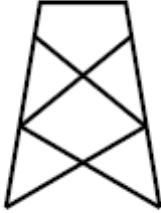
DESCRIPTION	ICON	DRAW RULES
<p>SPACE</p> <p>Static/Dynamic: N/A Symbol Set Code: 47 Code: 110000</p>	<p>N/A</p>	<p>No icon is associated with this entity. It is for hierarchal purposes only.</p>

PAGE INTENTIONALLY LEFT BLANK

APPENDIX J - SIGNALS INTELLIGENCE SYMBOLS

J.1 SCOPE

J.1.1 Scope. This appendix addresses symbols that support signals intelligence (SIGINT) in the C2 domain. The tables in this appendix present the icons and modifiers for the SIGINT domain. This appendix is a mandatory part of the standard. The information contained herein is intended for compliance.

J.2 APPLICABLE DOCUMENTS

Specific documents in [2.2](#) of this standard apply to this appendix.

J.3 DEFINITIONS

The definitions in [section 3](#) of this standard apply to this appendix.

J.4 GENERAL REQUIREMENTS

J.4.1 Organization. This appendix contains technical specifications, a symbol coding scheme, a symbology hierarchy and SIGINT symbology.

J.5 DETAILED REQUIREMENTS

J.5.1 Technical specifications. Composition, construction and display of symbols are explained in the detailed requirements section of the standard.

J.5.2 Symbol identification coding scheme. A symbol identification code (SIDC) is a numeric string that may be used to provide the unique identifier necessary to display or exchange symbol information between MIL-STD-2525 compliant systems. Refer to [Appendix A](#) for SIDC positions and descriptions.

J.5.3 Composition of SIGINT symbols. A standard method for constructing symbols is presented. Refer to [5.3.8](#) for an explanation of symbol composition. [Figure J-1](#) shows an example of a SIGINT symbol.

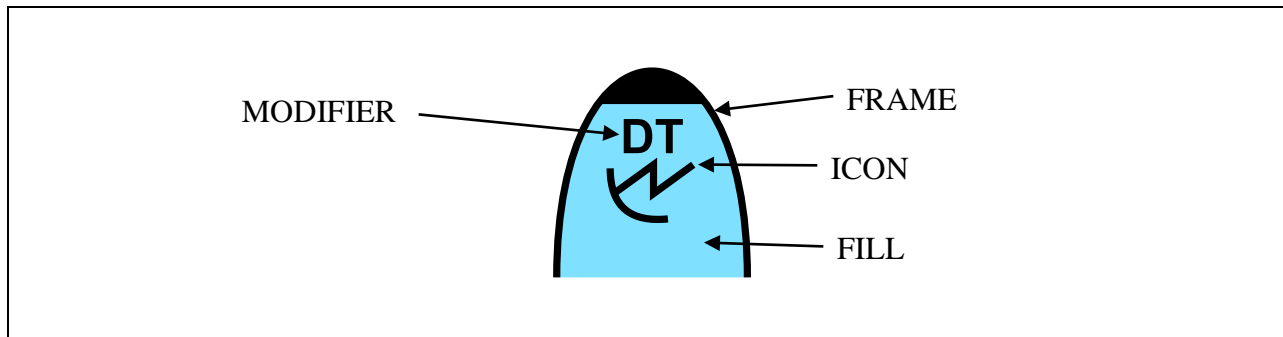
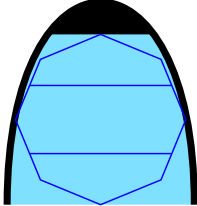
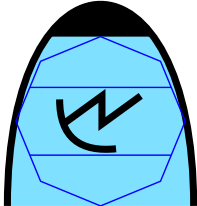
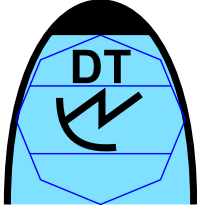
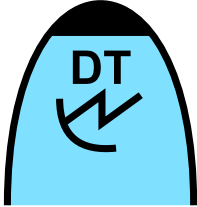

FIGURE J-1. Signals intelligence symbol components.

J.5.3.1 Symbol building process. [Table J-1](#) depicts the symbol building process for SIGINT symbols. The process is identical for icons and modifiers requiring the vertical bounding octagon.

TABLE J-I. Signal intelligences symbol building process.

STEP	DESCRIPTION	EXAMPLE
1.	<p>Choose the frame that matches the standard identity of the object from the appropriate dimension column in tables I, II, or III. In this example, the standard identity is friend and the dimension is space.</p> <p>The example depicts a “friendly space track.”</p>	
2.	<p>Choose an icon for the main sector of the bounding octagon. In this example, the icon is “radar,” a SIGINT entity type.</p> <p>The example depicts a “friendly space radar.”</p>	
3.	<p>If required, choose a modifier to depict an additional characteristic of the icon. In this example, the modifier is “data transmission,” a sector 1 modifier.</p> <p>The example depicts a “friendly space radar with data transmission capability.”</p> <p>Note: There are no sector 2 modifiers in SIGINT symbols.</p>	
4.	<p>The finished symbol will appear as shown in the example.</p>	

J.5.3.2 Icons and modifiers. All icons shall be placed within the main sector of the bounding octagon ([see table J-1](#)). When depicted, modifiers shall be placed in sector 1 as appropriate ([see table J-1](#)). There are no sector 2 modifiers in SIGINT. Only one modifier may be placed in each sector at a given time. Multiple modifiers in the same position are prohibited due to legibility concerns.

J.5.3.3 Amplifiers. The display of additional alphanumeric and graphical information on identity, movement and location and capabilities of a SIGINT symbol is dependent on the dimension of that symbol. A SIGINT symbol may be in the space, air, land, sea surface, or subsurface dimension. For example, if the SIGINT symbol is in the space dimension, then that symbol shall follow the amplifier requirements as stated in the space appendix. [See 5.1.6](#) for more information on amplifiers.

J.6 SIGINT SYMBOLS

J.6.1 SIGINT symbols. This section includes the lists of icons and modifiers for building SIGINT symbols.

J.6.2 SIGINT icons. [Table J-II](#) depicts SIGINT icons.

TABLE J-II. Signals intelligence icons.

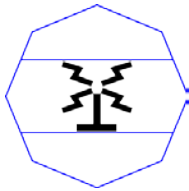
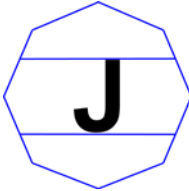
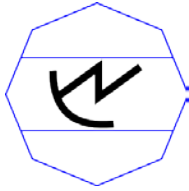
DESCRIPTION	ICON	REMARKS
<p>SIGNAL INTERCEPT</p> <p>Type: Entity Symbol Set Code: 50, 51, 52, 53, 54 Code: 110000 Icon Type: Full Octagon</p>	N/A	There is no icon associated with this entity.
<p>COMMUNICATIONS</p> <p>Type: Entity Type Entity: SIGNAL INTERCEPT Symbol Set Code: 50, 51, 52, 53, 54 Code: 110100 Icon Type: Main</p>		N/A
<p>JAMMER</p> <p>Type: Entity Type Entity: SIGNAL INTERCEPT Symbol Set Code: 50, 51, 52, 53, 54 Code: 110200 Icon Type: Main</p>		N/A
<p>RADAR</p> <p>Type: Entity Type Entity: SIGNAL INTERCEPT Symbol Set Code: 50, 51, 52, 53, 54 Code: 110300 Icon Type: Main</p>		N/A

J.6.3 SIGINT sector 1 modifiers. SIGINT sector 1 modifiers denote communications and radar categories based on dimension (for example, space, air, land, sea surface, or subsurface). [Table J-III](#) lists SIGINT sector 1 modifiers and illustrates their placement within the bounding octagon.

TABLE J-III. Signals intelligence sector 1 modifiers.

DESCRIPTION	CATEGORY	MODIFIER	REMARKS
ANTI-AIRCRAFT FIRE CONTROL Symbol Set Code: 52,53 Code: 01	LAND/SEA SURFACE RADAR		N/A
AIRBORNE SEARCH AND BOMBING Symbol Set Code: 51 Code: 02	AIR RADAR		N/A
AIRBORNE INTERCEPT Symbol Set Code: 51 Code: 03	AIR RADAR		N/A
ALTIMETER Symbol Set Code: 51 Code: 04	AIR RADAR		N/A
AIRBORNE RECONNAISSANCE AND MAPPING Symbol Set Code: 51 Code: 05	AIR RADAR		N/A
AIR TRAFFIC CONTROL Symbol Set Code: 51, 52, 53 Code: 06	AIR/LAND/SEA SURFACE RADAR		N/A
BEACON TRANSPONDER (NOT IFF) Symbol Set Code: 51, 52, 53, 54 Code: 07	AIR/LAND/SEA SURFACE/SUBSURFACE RADAR		N/A

TABLE J-III. Signals intelligence sector 1 modifiers - Continued.

DESCRIPTION	CATEGORY	MODIFIER	REMARKS
BATTLEFIELD SURVEILLANCE Symbol Set Code: 51, 52 Code: 08	AIR/LAND RADAR		N/A
CONTROLLED APPROACH Symbol Set Code: 52,53 Code: 09	LAND/SEA SURFACE RADAR		N/A
CONTROLLED INTERCEPT Symbol Set Code: 51,52,53 Code: 10	AIR/LAND/SEA SURFACE RADAR		N/A
CELLULAR/MOBILE Symbol Set Code: 51, 52, 53, 54 Code: 11	AIR/LAND/SEA SURFACE/SUBSURFACE COMMUNICATIONS		N/A
COASTAL SURVEILLANCE Symbol Set Code: 51 Code: 12	LAND RADAR		N/A
DECOY/MIMIC Symbol Set Code: 51, 52, 53, 54 Code: 13	AIR/LAND/SEA SURFACE/SUBSURFACE RADAR		N/A
DATA TRANSMISSION Symbol Set Code: 50, 51, 52, 53, 54 Code: 14	SPACE/AIR/LAND/SEA SURFACE/SUBSURFACE RADAR		N/A
EARTH SURVEILLANCE Symbol Set Code: 50 Code: 15	SPACE RADAR		N/A

TABLE J-III. Signals intelligence sector 1 modifiers - Continued.

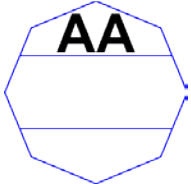
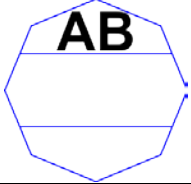
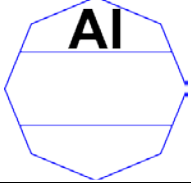
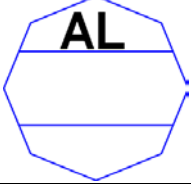
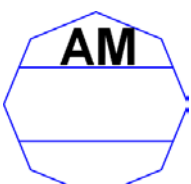
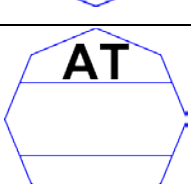
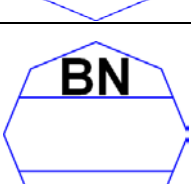

DESCRIPTION	CATEGORY	MODIFIER	REMARKS
EARLY WARNING Symbol Set Code: 51,52,53,54 Code: 16	AIR/LAND/SEA SURFACE/SUBSURFACE RADAR		N/A
FIRE CONTROL Symbol Set Code: 51,52,53 Code: 17	AIR/LAND/SEA SURFACE RADAR		N/A
GROUND MAPPING Symbol Set Code: 51 Code: 18	AIR RADAR		N/A
HEIGHT FINDING Symbol Set Code: 52,53 Code: 19	LAND/SEA SURFACE RADAR		N/A
HARBOR SURVEILLANCE Symbol Set Code: 52 Code: 20	LAND RADAR		N/A
IDENTIFICATION, FRIEND OR FOE (INTERROGATOR) Symbol Set Code: 50, 51, 52, 53, 54 Code: 21	SPACE/AIR/LAND/SEA SURFACE/SUBSURFACE RADAR		N/A
INSTRUMENT LANDING SYSTEM Symbol Set Code: 52, 53 Code: 22	LAND/SEA SURFACE RADAR		N/A
IONOSPHERIC SOUNDING Symbol Set Code: 51, 52 Code: 23	AIR/LAND RADAR		N/A

TABLE J-III. Signals intelligence sector 1 modifiers - Continued.

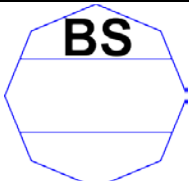
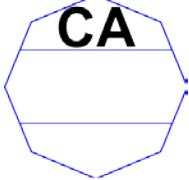
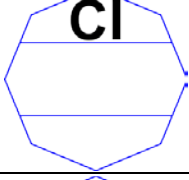
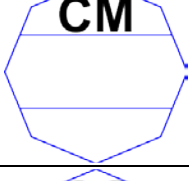
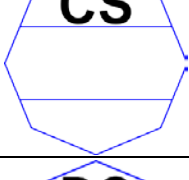
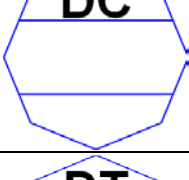
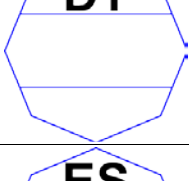
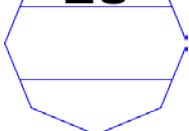
DESCRIPTION	CATEGORY	MODIFIER	REMARKS
IDENTIFICATION, FRIEND OR FOE (TRANSPONDER) Symbol Set Code: 50, 51, 52, 53, 54 Code: 24	SPACE/AIR/LAND/SEA SURFACE/SUBSURFACE RADAR		N/A
BARRAGE JAMMER Symbol Set Code: 50, 51, 52, 53, 54 Code: 25	SPACE/AIR/LAND/SEA SURFACE/SUBSURFACE JAMMER		N/A
CLICK JAMMER Symbol Set Code: 50, 51, 52, 53, 54 Code: 26	SPACE/AIR/LAND/SEA SURFACE/SUBSURFACE JAMMER		N/A
DECEPTIVE JAMMER Symbol Set Code: 50, 51, 52, 53, 54 Code: 27	SPACE/AIR/LAND/SEA SURFACE/SUBSURFACE JAMMER		N/A
FREQUENCY SWEPT JAMMER Symbol Set Code: 50, 51, 52, 53, 54 Code: 28	SPACE/AIR/LAND/SEA SURFACE/SUBSURFACE JAMMER		N/A
JAMMER (GENERAL) Symbol Set Code: 50, 51, 52, 53, 54 Code: 29	SPACE/AIR/LAND/SEA SURFACE/SUBSURFACE JAMMER		N/A
NOISE JAMMER Symbol Set Code: 50, 51, 52, 53, 54 Code: 30	SPACE/AIR/LAND/SEA SURFACE/SUBSURFACE JAMMER		N/A
PULSED JAMMER Symbol Set Code: 50, 51, 52, 53, 54 Code: 31	SPACE/AIR/LAND/SEA SURFACE/SUBSURFACE JAMMER		N/A

MIL-STD-2525D - APPENDIX J

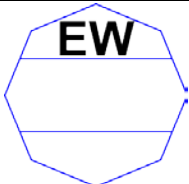
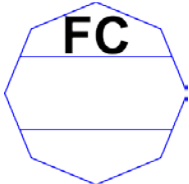
TABLE J-III. Signals intelligence sector 1 modifiers - Continued.

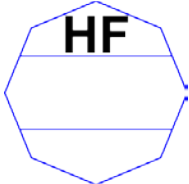
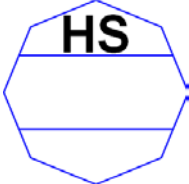
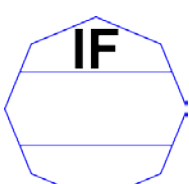
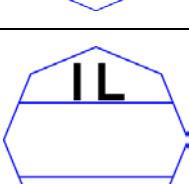
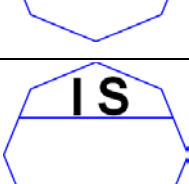
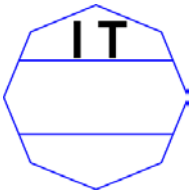
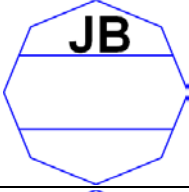
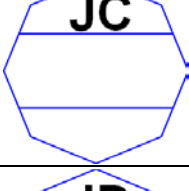
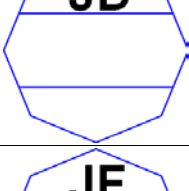
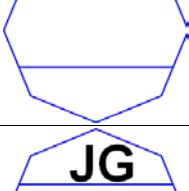
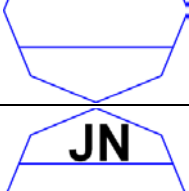
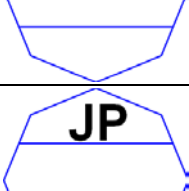
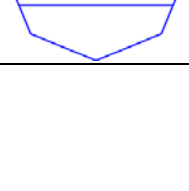
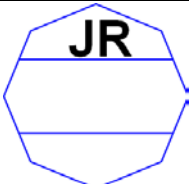
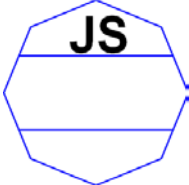
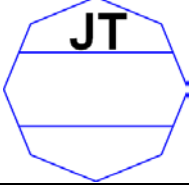
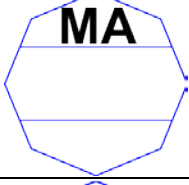
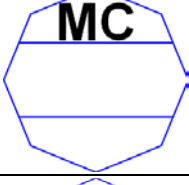
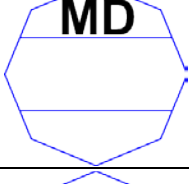
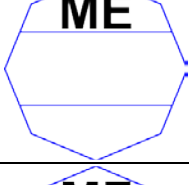
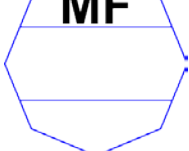
DESCRIPTION	CATEGORY	MODIFIER	REMARKS
REPEATER JAMMER Symbol Set Code: 50, 51, 52, 53, 54 Code: 32	SPACE/AIR/LAND/SEA SURFACE/SUBSURFACE JAMMER		N/A
SPOT NOISE JAMMER Symbol Set Code: 50, 51, 52, 53, 54 Code: 33	SPACE/AIR/LAND/SEA SURFACE/SUBSURFACE JAMMER		N/A
TRANSPONDER JAMMER Symbol Set Code: 50, 51, 52, 53, 54 Code: 34	SPACE/AIR/LAND/SEA SURFACE/SUBSURFACE JAMMER		N/A
MISSILE ACQUISITION Symbol Set Code: 51,52,53 Code: 35	AIR/LAND/SEA SURFACE RADAR		N/A
MISSILE CONTROL Symbol Set Code: 50, 51, 52, 53, 54 Code: 36	SPACE/AIR/LAND/SEA SURFACE/SUBSURFACE JAMMER		N/A
MISSILE DOWNLINK Symbol Set Code: 51 Code: 37	AIR RADAR		N/A
METEOROLOGICAL Symbol Set Code: 51, 52, 53 Code: 38	AIR/LAND/SEA SURFACE RADAR		N/A
MULTI-FUNCTION Symbol Set Code: 50, 51, 52, 53, 54 Code: 39	SPACE/AIR/LAND/SEA SURFACE/SUBSURFACE JAMMER		Two or more of EW, TA, TT, MG, TI

MIL-STD-2525D - APPENDIX J

TABLE J-III. Signals intelligence sector 1 modifiers - Continued.



DESCRIPTION	CATEGORY	MODIFIER	REMARKS
MISSILE GUIDANCE Symbol Set Code: 51,52,53 Code: 40	AIR/LAND/SEA SURFACE RADAR		N/A
MISSILE HOMING Symbol Set Code: 51 Code: 41	AIR RADAR		N/A
MISSILE TRACKING Symbol Set Code: 50, 51, 52, 53, 54 Code: 42	SPACE/AIR/LAND/SEA SURFACE/SUBSURFACE JAMMER		N/A
NAVIGATION/GENERAL Symbol Set Code: 50, 51, 52, 53, 54 Code: 43	SPACE/AIR/LAND/SEA SURFACE/SUBSURFACE JAMMER		N/A
NAVIGATION/DISTANCE MEASURING EQUIPMENT Symbol Set Code: 50, 51, 52, 53, 54 Code: 44	SPACE/AIR/LAND/SEA SURFACE/SUBSURFACE JAMMER		N/A
NAVIGATION/TERRAIN FOLLOWING Symbol Set Code: 50, 51, 52, 53, 54 Code: 45	SPACE/AIR/LAND/SEA SURFACE/SUBSURFACE JAMMER		N/A
NAVIGATION/WEATHER AVOIDANCE Symbol Set Code: 51, 52, 53, 54 Code: 46	AIR/LAND/SEA SURFACE/SUBSURFACE JAMMER		N/A

TABLE J-III. Signals intelligence sector 1 modifiers - Continued.

DESCRIPTION	CATEGORY	MODIFIER	REMARKS
OMNI-LINE OF SIGHT (LOS) Symbol Set Code: 51,52,53,54 Code: 47	AIR/LAND/SEA SURFACE/SUBSURFACE COMMUNICATIONS		N/A
PROXIMITY FUSE Symbol Set Code: 51 Code: 48	AIR RADAR		N/A
POINT-TO-POINT LINE OF SIGHT (LOS) Symbol Set Code: 50, 51, 52, 53, 54 Code: 49	SPACE/AIR/LAND/SEA SURFACE/SUBSURFACE COMMUNICATIONS		N/A
INSTRUMENTATION Symbol Set Code: 50, 51, 52, 53, 54 Code: 50	SPACE/AIR/LAND/SEA SURFACE/SUBSURFACE RADAR		N/A
RANGE ONLY Symbol Set Code: 50, 51, 52, 53, 54 Code: 51	SPACE/AIR/LAND/SEA SURFACE/SUBSURFACE RADAR		N/A
SONOBUOY Symbol Set Code: 53, 54 Code: 52	SEA SURFACE/SUBSURFACE RADAR		N/A
SATELLITE DOWNLINK Symbol Set Code: 50 Code: 53	SPACE COMMUNICATIONS		N/A
SPACE Symbol Set Code: 50, 51, 52, 53, 54 Code: 54	SPACE/AIR/LAND/SEA SURFACE/SUBSURFACE RADAR		N/A

TABLE J-III. Signals intelligence sector 1 modifiers - Continued.

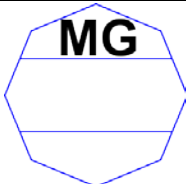

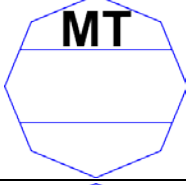
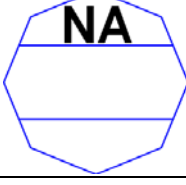
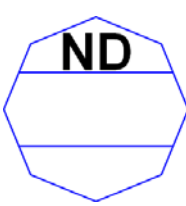
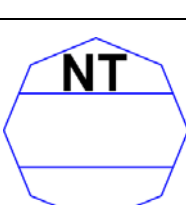
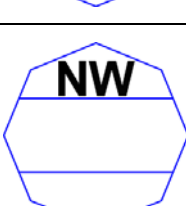
DESCRIPTION	CATEGORY	MODIFIER	REMARKS
SURFACE SEARCH Symbol Set Code: 50, 51, 52, 53, 54 Code: 55	SPACE/AIR/LAND/SEA SURFACE/SUBSURFACE RADAR		N/A
SHELL TRACKING Symbol Set Code: 52 Code: 56	LAND RADAR		N/A
SATELLITE UPLINK Symbol Set Code: 51,52,53,54 Code: 57	AIR/LAND/SEA SURFACE/SUBSURFACE COMMUNICATIONS		N/A
TARGET ACQUISITION Symbol Set Code: 50,51,52,53,54 Code: 58	SPACE/AIR/LAND/SEA SURFACE/SUBSURFACE RADAR		N/A
TARGET ILLUMINATION Symbol Set Code: 51,52,53 Code: 59	AIR/LAND/SEA SURFACE RADAR		N/A
TROPOSPHERIC SCATTER Symbol Set Code: 52 Code: 60	LAND COMMUNICATIONS		N/A
TARGET TRACKING Symbol Set Code: 50, 51, 52, 53, 54 Code: 61	SPACE/AIR/LAND/SEA SURFACE/SUBSURFACE RADAR		N/A
UNKNOWN Symbol Set Code: 50, 51, 52, 53, 54 Code: 62	SPACE/AIR/LAND/SEA SURFACE/SUBSURFACE RADAR		N/A

TABLE J-III. Signals intelligence sector 1 modifiers - Continued.

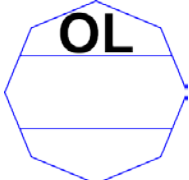
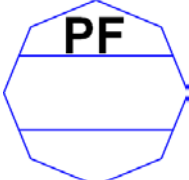
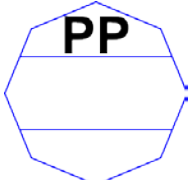
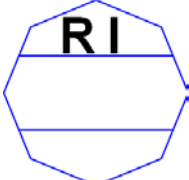
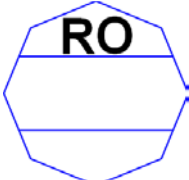
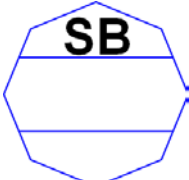
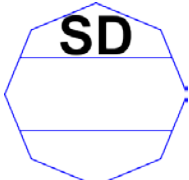
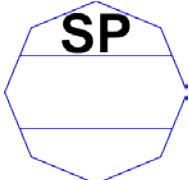
DESCRIPTION	CATEGORY	MODIFIER	REMARKS
VIDEO REMOTING Symbol Set Code: 50, 51, 52, 53, 54 Code: 63	SPACE/AIR/LAND/SEA SURFACE/SUBSURFACE RADAR		N/A
EXPERIMENTAL Symbol Set Code: 50, 51, 52, 53, 54 Code: 64	SPACE/AIR/LAND/SEA SURFACE/SUBSURFACE RADAR		N/A

APPENDIX K - USE OF WARFIGHTING SYMBOLS
IN PSEUDO-THREE-DIMENSIONAL (2.5D) DISPLAYS

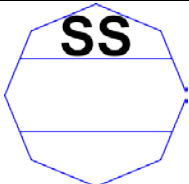
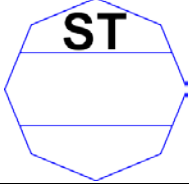
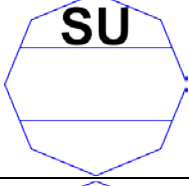
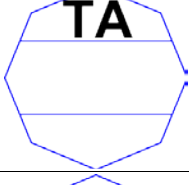
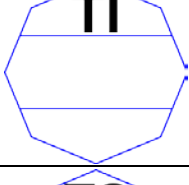
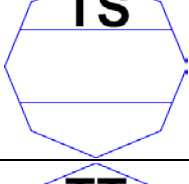
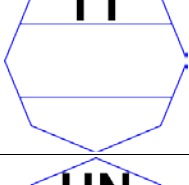
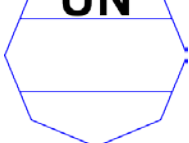
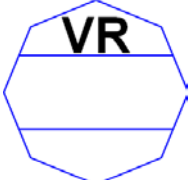
K.1 SCOPE

K.1.1 Scope. This appendix provides definitions and guidelines for display of Common Warfighting Symbolology in pseudo-three-dimensional displays, also known as 2.5D displays. In the context of this appendix, 2.5D display refers to the presentation of information that gives the perception of depth or varying distance, as in a non-orthogonal viewing angle. In other words, a viewing angle that is not perpendicular to the surface of the Earth. This is in contrast to several other emerging graphic technologies that will allow for viewing in stereographic or full three-dimensional display. In stereo display, dual images are used to recreate a three-dimensional perception in the human brain.

a. Although there is some discussion of the use of 2.5D symbols, the primary focus of this appendix is the display of the two-dimensional symbols contained in MIL-STD-2525 in a 2.5D display of the surrounding environment. Modeling and simulation standards and methods of portrayal would be more suitable for the display of 2.5D or full three-dimensional symbols and models.

b. This appendix is not a mandatory part of the standard. It is intended for guidance only.

K.2 REFERENCES

This section is not applicable to this standard.

K.3 DEFINITIONS

K.3.1 Billboarding: A method for portraying a symbol in a 2.5D display in which the symbol is perpendicular to the viewing angle.

K.3.2 Cubing: A method for portraying a symbol in a 2.5D display in which the symbol is overlaid on a cube to present a surface visible from the viewing angle.

K.3.3 Curve (line): One-dimensional geometric primitive representing the continuous image of a line.

K.3.4 Geospatial: Pertaining to the geographic location and characteristics of natural or constructed features and boundaries on, above, or below the Earth's surface; especially referring to data that is geographic and spatial in nature.

K.3.5 Glyph: A symbol (as a curved arrow on a road sign) that conveys information nonverbally.

K.3.6 Icon: A sign (as a word or graphic symbol) whose form suggests its meaning.

K.3.7 Image: The optical counterpart of an object produced by an optical device (as a lens or mirror) or an electronic.

K.3.8 Marker post (lollipop): A method for portraying a symbol in a 2.5D display in which the symbol is billboarded but also raised above or below the terrain surface by a vertical line.

K.3.9 Model: A miniature representation or simulation.

K.3.10 Pictograph: A picture representing a word or idea; a hieroglyph.

K.3.11 Point: Zero-dimensional geometric primitive, representing a position.

K.3.12 Solid (volume): Three-dimensional geometric primitive, representing the continuous image of a region of Euclidean three space.

K.3.13 Surface (area): Two-dimensional geometric primitive locally representing a continuous image of a region of a plane.

K.3.14 Symbicon: A hybrid of a symbol and icon which attempts to combine the best identification performance benefits of each representation.

K.3.15 Symbol: An object that presents information (MIL-STD-2525). An arbitrary or conventional sign used in writing or printing relating to a particular field to represent operations, quantities, elements, relations, or qualities.

K.3.16 Terrain draping: A method for portraying a symbol in a 2.5D display in which the symbol is overlaid on a terrain surface.

K.3.17 Three-dimensional: Giving the illusion of depth or varying distances.

K.3.18 Two-dimensional: Lacking depth of characterization.

K.4 PSEUDO-THREE-DIMENSIONAL (2.5D) SYMBOLIZATION

K.4.1 Introduction. Symbols are used to convey information about objects in space. In most traditional command and control applications, this has been accomplished by an orthogonal (directly overhead) view, such as when looking at a map. Command and control symbols have been overlaid on top of geospatial information or a “map background” to provide a geospatial context to locate the military object of interest at a geographic position. Attributes of the object are visually encoded in the symbol to communicate information about the object to the observer.

a. As command and control symbology has evolved from hand-annotated paper maps to automated computer display screens, views other than orthogonal have become practical. Non-overhead views or dynamic viewing positions such as “fly-through” displays provide new ways in which a warfighter can better perceive and understand the operational environment.

b. This appendix establishes some basic terminology for addressing portrayal of information in 2.5D displays and provides advantages, disadvantages and guidance on some of these methods of display. Although some aspects of 2.5D symbols are discussed, the primary focus of this appendix is on portrayal of the two-dimensional symbols contained in MIL-STD-2525 in a 2.5D display. The modeling and simulation (M&S) community has been portraying the environment in 2.5D for a long time and there are M&S standards and symbol libraries available for 2.5D symbology ([see section K.5.2](#)).

c. This appendix is not intended to be a “standard” as such. New developments in the information technology, computer graphics and the geospatial information systems (GIS) and modeling and simulation industries will undoubtedly eclipse the information provided here.

K.4.2 When to use 2.5D displays. The paramount point when considering the use of 2.5D displays is to recognize that a 2.5D display is not necessarily better than a two-dimensional display for every application. A 2.5D display may look neat and impress a viewing audience, but it must really be evaluated as to whether it presents information better or not as good as a traditional two-dimensional display. Research indicates that using 2.5D displays provide advantages such as –

- a. Provide a visual representation that may be useful in understanding the shape or rough spatial layout of scenes
- b. May be more intuitive and natural for use
- c. Are preferred by users
- d. May present clearer picture of tactical information (eliminate need to search text boxes for attributes such as altitude and to do mental integration of information from different views). These benefits may also be engineered into 2D displays as well.¹

Conversely, 2.5D displays have several disadvantages as well:

- a. Are prone to distortion (due to association with parameters of perspective)
- b. Are prone to clutter (less display area near horizon, so more objects are packed into a smaller area; addition of depth cues such as drop lines increase number of objects displayed)
- c. Are poor for tasks requiring precision, both about objects (e.g. realistic icons do not scale well; distant objects may be too small to recognize) and distances and angles (from foreshortening and inadequate and conflicting depth cues).

Research is mixed concerning performance benefits of using 2D or 2.5D displays largely due to the great variety of factors considered in the studies. Also, users may prefer (or rate highly) displays that actually hinder rather than enhance their performance.²

¹ Smallman, H. S., St. John, M., Oonk, H. M. and Cowen, M. B. (2001), Information availability in 2D and 3D displays, IEEE Computer Graphics and Application, 21, 51-57.

K.4.3 Taxonomy of symbols and displays. Symbols can be classified many different ways, including subject area, data structure and visual aspects. A basic taxonomy might look something like this:

K.4.3.1 Subject Area.

- a. Operational symbols – military operations and control measures
- b. Geospatial symbols – provides geospatial context (map background)

K.4.3.2 Delineation Type.

- a. Point – one coordinate point
- b. Line – a series of coordinate points
- c. Area – a series of coordinate points in which the line creates a polygon
- d. Volume – a polygon or shape with a vertical component

K.4.3.3 Degree of Abstraction.

- a. Abstract symbol – a symbol representing an object based on learned association
- b. Pictograph or icon – a symbol representing an object based on the symbol looking like the object
- c. Symbicon – a hybrid of a symbol and an icon which attempts to combine the best identification performance benefits of each representation.
- d. Two-dimensional image – a picture of the object based on varying intensity of reflected energy from the object
- e. Pseudo-three-dimensional model – a physical or digital representation of an object

K.4.3.4 Dimensionality.

- a. Two-dimensional – a symbol lacking depth of characterization
- b. Pseudo-three-dimensional (2.5D) – a symbol giving the illusion of depth or varying distances
- c. Three-dimensional – a symbol displayed by stereoscopic, holographic or other means that provides a complete representation of three dimensions.

² Smallman, H. S., St. John, M., Oonk, H. M. and Cowen, M. B. (2005), Niive Realism: Misplaced faith in the utility of realistic displays, *Ergonomics in Design*, 13(3), 6-13, Fernandes, K. Usability of 3D Perspective Displays, SPAWAR and St. John, M, Cowen, M.B., Smallman, H.S. and Oonk, H.M. (2001) The use of 2D and 3D displays for shape understanding versus relative position tasks. *Human Factors*, 43, 79-98.

K.4.3.5 Relative to terrain.

- a. Ground clamped – symbol is shown on terrain
- b. Elevated – symbol is raised above terrain surface

K.4.4 Geospatial (map) symbols. Geospatial symbology generally follows the “earth surface” and can be draped over elevation data. Typically, operational symbols are shown on a map background to provide a positional reference. Digital geospatial information can be classified into two types.

K.4.4.1 Raster data. Raster data is a method of representing geospatial data characterized by a matrix of evenly spaced rows and columns of data points. These data points (called "pixels" in image and scanned map data) typically represent some value at that point, while the position within the columns and rows determines the geographic position. Raster data structures are typically used to record scanned maps and charts (MC&G graphic data), image data, or gridded data, such as terrain elevation posts in an elevation model.

K.4.4.2 Vector data. Vector data represents each cartographic feature by an entity description (feature code) and a spatial extent (geographic position). Geographic position may be two-dimensional (horizontal position only) or three-dimensional (including elevation). Features are categorized as point, line, or area features. The position of a point feature is described by a single coordinate pair (or triplet for three dimensional data). The spatial extent of a line feature is described by a string of coordinates of points lying along the line, while the extent of an area feature is described by treating its boundary as a line feature. Vector data may be stored in a sequential, chain node, or topological data structure.

K.4.5 Imagery. By its nature, imagery is not symbolized but instead relies on variations in intensity of captured light (or other portion of spectrum or other phenomena) to create a visual picture of the object or phenomena being represented. Imagery can be used as a background display or the picture of an object or piece of equipment.

- a. There is a significant difference between raster geospatial data or an image and vector geospatial data. In vector data, geographic features can be filtered or turned on or off in a vector display. In a raster display, the map or image content is fixed and you see whatever was shown on the scanned paper map or image.

K.4.6 Optimum display method. Each type of symbolization has advantages and disadvantages. There is no one right answer. The intended application will determine which method best meets the intended use of the display.

K.5 GUIDANCE AND PORTRAYAL CONSIDERATIONS IN PSEUDO-THREE-DIMENSIONAL (2.5D) DISPLAYS

K.5.1 Use of 2D symbols in 2.5D display. The symbols provided in the appendices of MIL-STD-2525 were designed for two-dimensional display. They can be used in a 2.5D display, using various visualization techniques, some of which are described below. The visualizations described here are not intended to be an all-encompassing or comprehensive list but merely some

of the more common approaches. The intent of this appendix is to provide guidance to implementers on some of the advantages and disadvantages of these visualization techniques.

K.5.1.1.1 Visualization of icons. The symbols in the various appendices of MIL-STD-2525 for space, air, land, maritime (surface and subsurface), meteorology, signals intelligence, etc., symbolize units, equipment and installations as point symbols. Each is associated with a single geographic coordinate. The following paragraphs describe several methods of symbolizing point icons.

K.5.1.1.1.1 Terrain draping. One simple method of displaying two-dimensional symbols in a 2.5D display is to simply place the 2D symbols over the 2.5D surface model (see figure K-1). This makes it appear as if operational symbols were large flags laid out on the ground. With draping, no changes to existing 2D symbols are required. Since the viewing angle is not perpendicular, symbols may be distorted in shape. Depending on the underlying terrain, some symbols may be obscured by higher terrain in between the symbol and the viewing position.

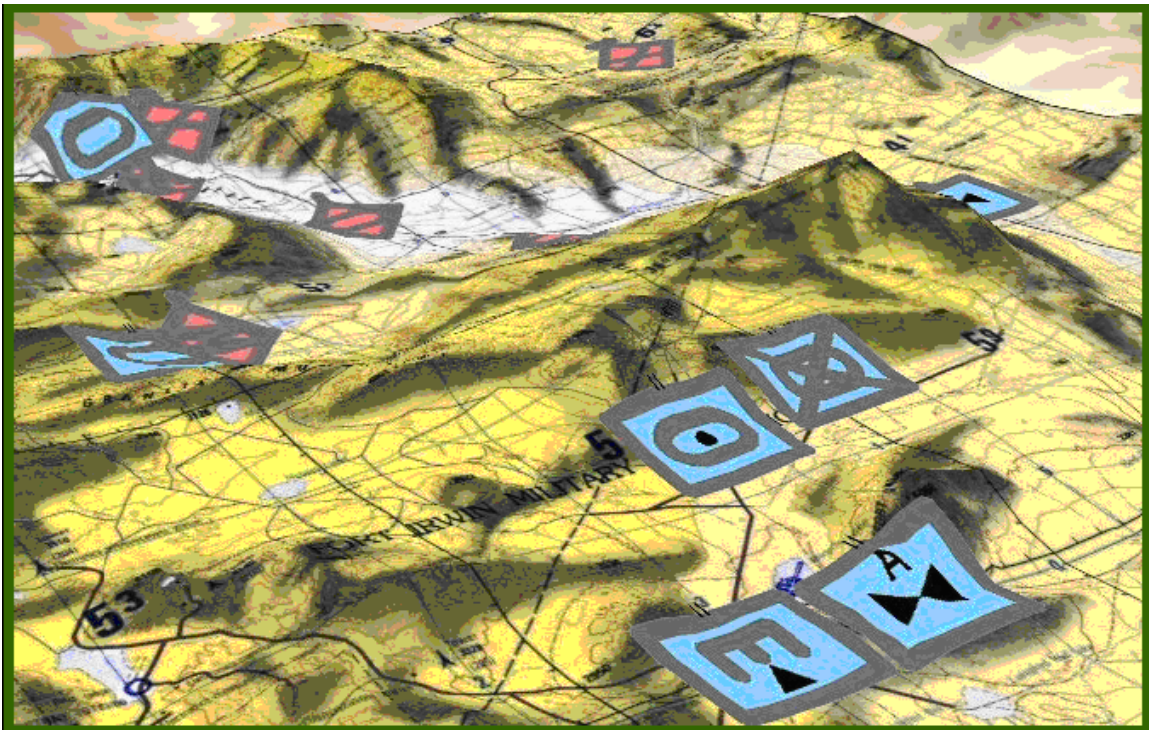

FIGURE K-1. Example of terrain draping of icons.
(Static MOLE layer displayed in ArcGlobe)

K.5.1.1.1.2 Billboarding. Billboarding is a technique in which a two-dimensional symbol is positioned vertically or perpendicular to the view angle (see figure K-2). This makes symbols easier to see than if they were draped over the terrain but is much more computationally demanding, sometimes affecting system performance. Although used in systems, the performance benefits of billboarding have not been validated with performance data. There are several factors that must be considered when orienting the billboard as well. Symbols placed on

the ground have to be elevated enough so the entire symbol is visible. If the center of the symbol was co-located with the position on the ground surface, the bottom half of the symbol would be obscured. Billboarding is conceptually different from lollipopping. In fact most billboard displays are raised above ground level. Billboarding refers to placing the 2D symbol perpendicular to view angle, while lollipopping or using a marker post refers to elevating the symbol above or below the terrain surface.

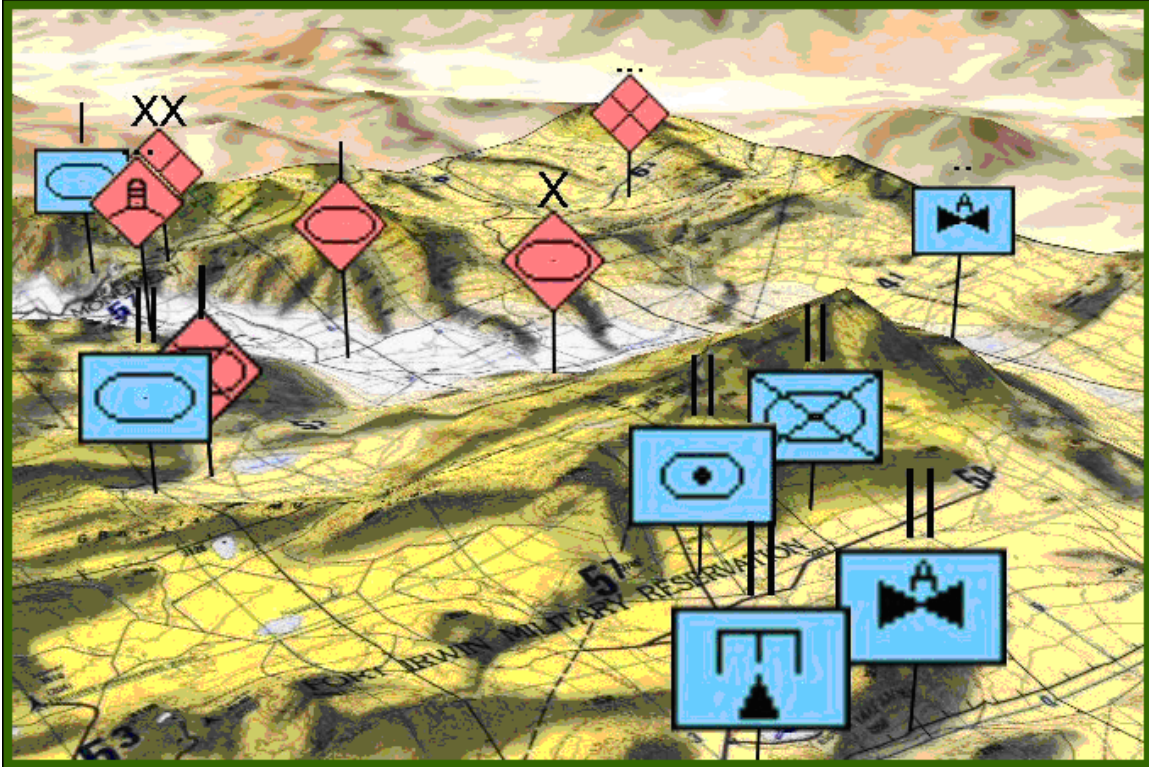

FIGURE K-2. Example of billboarding of icons.
(TOC 3D display)

K.5.1.1.3 Cubing. An alternative to billboarding is to project the 2D symbol onto a 2.5D shape, such as a cube ([see figure K-3](#)). As with billboarding, cubes can also be elevated above the terrain surface.



FIGURE K-3. Example of cubing of icons.

K.5.1.1.4 Marker post. In many cases, billboarded or cubed symbols are raised above the ground surface using a marker post, a technique sometimes called “lollipopping” (see figure K-4). The user can set an arbitrary height above ground surface and drop down lines connect the symbol to its ground location. In a 2.5D display, tracks that are actually above or below ground or water surface can be portrayed in their actual location. Lollipopping has the potential to create confusion with the actual altitude of an above or below-ground/water track. For example, it might appear that a helicopter is flying underneath a tank. Care must also be taken to distinguish between symbols raised to an arbitrary height above or below terrain and those symbols showing an actual altitude/depth, if both types are used in the same display.



FIGURE K-4. Example of marker posts.
(TOC 3D display)

K.5.1.2 Visualization of control measure symbols. The control measure symbols in MIL-STD-2525 are more complex than the simple icons in appendix A and contain point, line and area symbols. The techniques for portrayal of line and area symbols are generally similar to the point symbols. Lines may be “draped” over the terrain; but, as with points, draping creates the potential for a symbol to be obscured by intervening terrain (see figure K-5). Line symbols can be extruded above the terrain for visual emphasis, forming what appear to be walls on the terrain surface (see figure K-6). These walls could be used as a background for presenting additional information, such as echelon, status, etc.

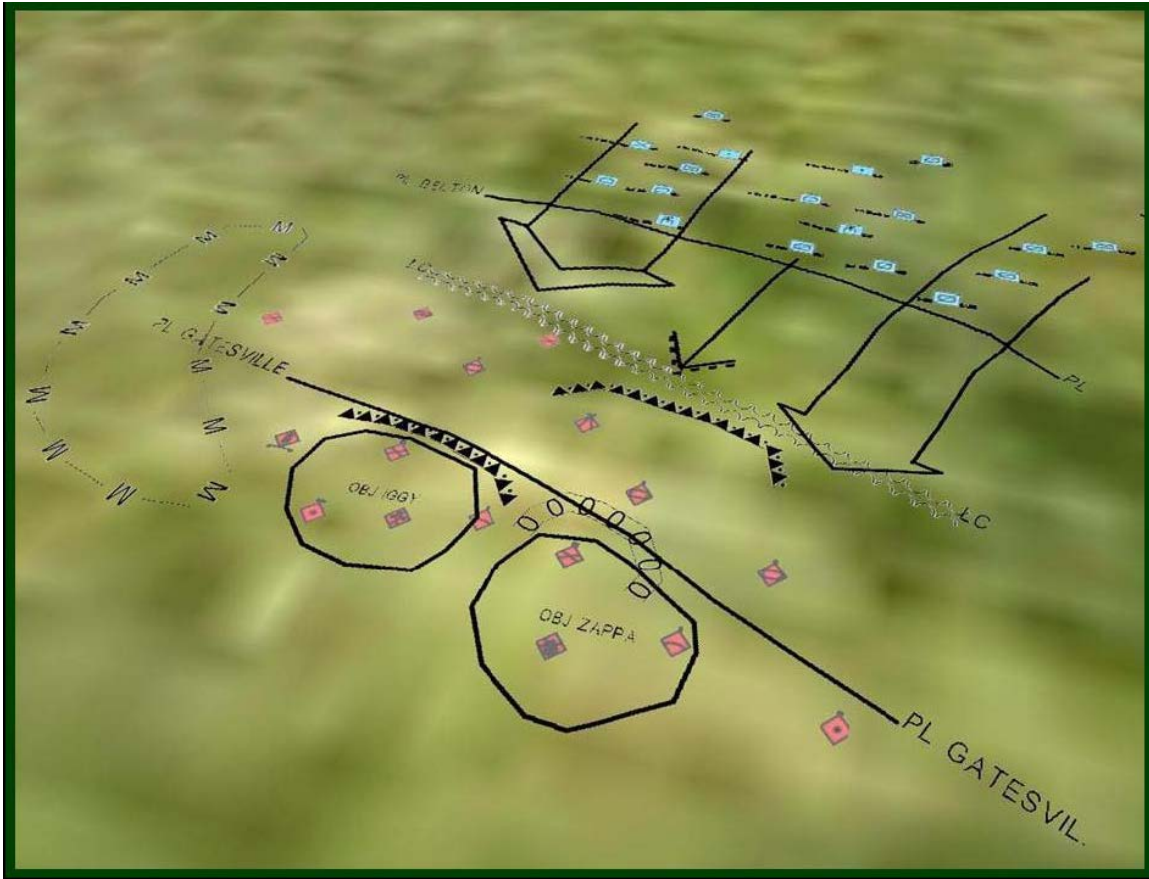

FIGURE K-5. Example of draped control measure symbols symbols.
(MOLE in ArcGlobe)

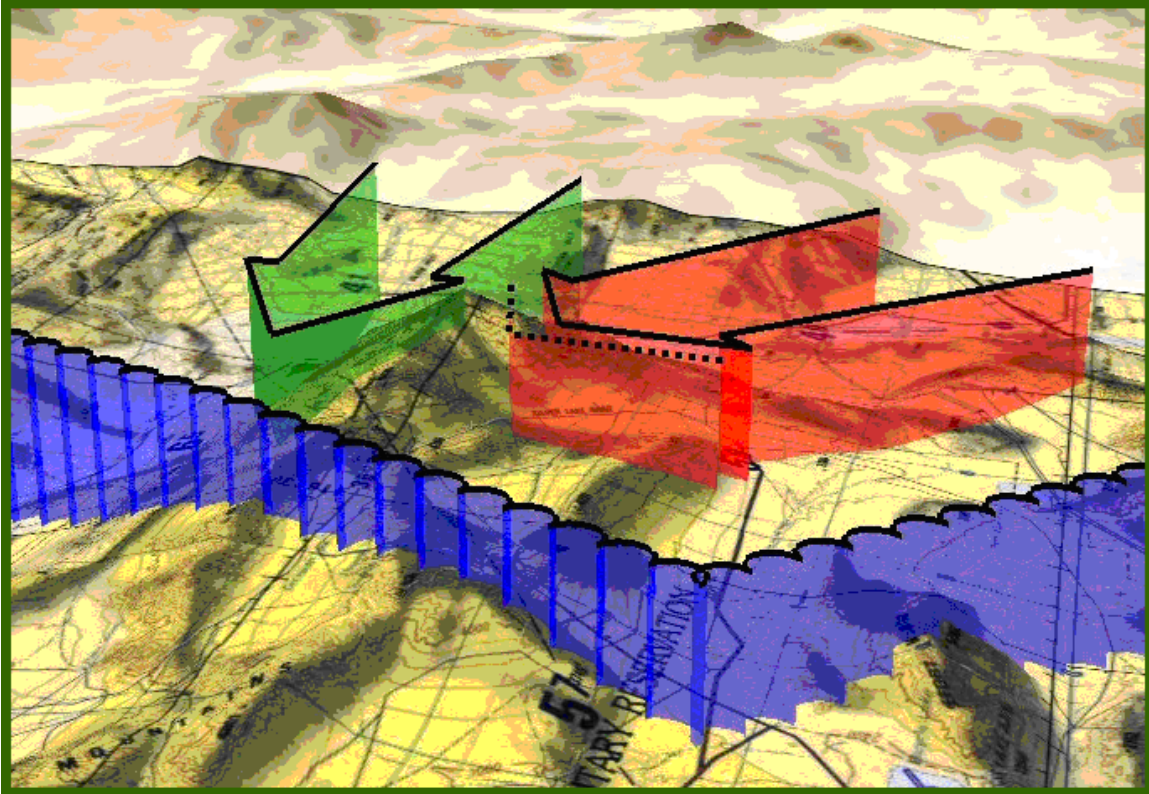

FIGURE K-6. Example of extruded control measure symbols symbols.
(TOC 3D display)

K.5.1.3 Symbicon. A symbicon is a hybrid of an abstract symbol with a pictograph or icon that increases the ease of identifying an object³ (see figure K-7). A typical symbicon may combine the identification code of a symbol, for example “B” for bomber, with the stylized silhouette of an aircraft.

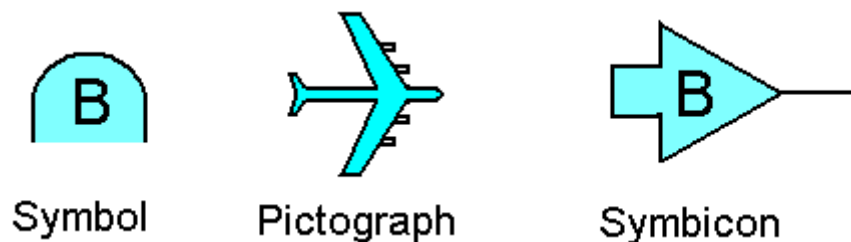

FIGURE K-7. Example of a symbicon.

K.5.2 Pseudo-three-dimensional models. Many systems are starting to use 2.5D models to represent military objects, rather than the 2D symbols contained in MIL-STD-2525 (see figure K-8). Models may work well for portrayal of individual platforms or systems, such

³ Symbicons: Advanced Symbology for Two-dimensional and Three-dimensional Displays, SPAWAR TR 1850, February 2001

as a tank or aircraft, but models work less well or may be impractical for symbolizing larger units. Although in general users prefer to look at realistic icons, they result in slower, error-prone performance.⁴ The level of detail provided by the model may also create recognition problems in the display that reflect the situation in the real world. For example, if an operator were unfamiliar with the appearance of a particular weapons system, it would not make much sense to use a 2.5D model of that weapons system to identify the equipment type. You would also expect recognition errors to occur if two weapons systems were similar in appearance. Overall, traditional symbols were more useful when determining platform identity and affiliation are required. Icons are better for determining some aspects of direction of movement.⁵

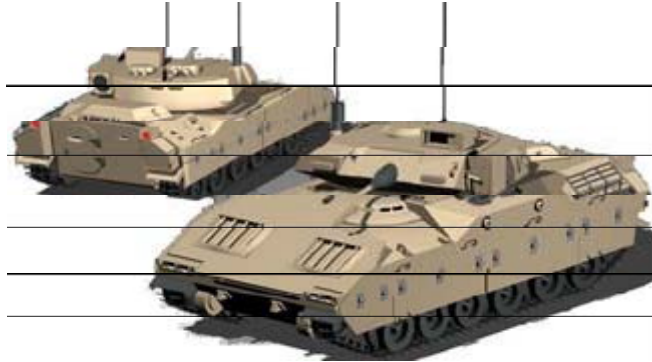

FIGURE K-8. Examples of pseudo-three-dimensional models.

K.5.2.1 Modeling and Simulation (M&S) standards. The International Organization for Standardization (ISO) 18023, Computer Graphics and Image Processing – Synthetic Environment Data Representation and Interchange Specification (SEDRIS) suite of standards are used for the exchange of modeling and simulation data.

K.5.2.2 Model libraries. The DOD maintains several libraries of reusable digital models of weapons systems at:

- a. Army Model Exchange: <https://modelexchange.army.mil>
- b. M&S Glossary: http://www.msco.mil/MSGlossary_ABR_M.html
- c. M&S Coordination Office: <http://msco.mil/>
- d. M&S Resource Repository System: http://www.msco.mil/resource_discovery.html

K.5.3 Design considerations for symbology in a 2.5D display.

K.5.3.1 Symbol location. One important function of a symbol is to indicate where the object is located. MIL-STD-2525, [Section 5.3.11](#) requires that point icons be positioned so the

⁴ Smallman, H.S., St. John, M.B., Oonk, H.M. and Cowen, M.B. (2000) Track recognition using two-dimensional symbols or three-dimensional realistic icons. SPAWAR Technical Report 1818.

⁵ Searching for Tracks Imaged as Symbols or Realistic Icons: A Comparison Between Two-Dimensional and Three-Dimensional Displays, SPAWAR TR 1854, April 2001

geometric center, or center of mass of the symbol, corresponds to the actual location of the object. Certain other control measure symbols have specified “anchor points” that differ from the center of mass of the symbol.

K.5.3.1.1 Submergence of symbols. If a symbol is overlain on the terrain “terrain draping,” it is possible to tie the center of mass of the symbol to the symbol location as in a two-dimensional display and conform to the general rules of MIL-STD-2525. If, however, the symbols are billboarded or shown vertically, then linking the symbol location to the center of mass of the symbol will result in the bottom half of the symbol being below the terrain surface. Billboard displays generally place bottom of the symbol on the terrain surface. This problem does not occur if the object is an air or sub-surface track and is far enough above or below the terrain surface (ground/water).

K.5.3.1.2 Height above/below terrain surface. Some 2.5D displays use the “lollipop” technique to elevate symbols a fixed distance above the terrain surface. This works well for ground tracks but may cause confusion if ground and air tracks were shown in the same display, since some symbols will be raised an arbitrary height while air tracks will generally show actual altitude of the track.

K.5.3.1.3 Estimating track position. Studies have shown that estimating a track position in a 2.5D display is difficult because many of the visual cues that the human brain uses to estimate a location cannot be duplicated in a 2.5D digital display. Operator performance is increased if artificial cues are added, typically a drop line or drop shadow. A drop line is a vertical line from the above-surface object to the terrain surface. A drop shadow is a silhouette of the object on the terrain surface. These artificial cues can contribute to display clutter. Even two-dimensional displays will benefit by having a distinct “locator point” on the symbol, rather than just using the center of mass of the symbol.⁶

K.5.3.2 Perspective. In a traditional two-dimensional (map-like) display, the perspective is “orthogonal” or viewed from directly overhead; so, there is no change of scale over the display. In a 2.5D view the scale of the display decreases (gets smaller) as distance from the observer increases. This creates difficulty in perceiving the actual location of an object in space. In a two-dimensional display, the elevation of an object is not obvious, but the horizontal position (x,y coordinates) is not in doubt. In a 2.5D display, the latitude, longitude and elevation (x, y and z) aspects of location are each ambiguous. When viewing an object in the real world, a human observer uses a number of visual cues to determine location in three-dimensional space. Objects become smaller with increasing distance. Illumination provides variation in light and dark to specify shape in depth. Closer objects block out objects that are farther away. People see in stereo vision and can judge how far away an object is based on the slight differences in the image in their right and left eyes. In a digital display, many of these real-world cues are impossible or impractical to reproduce. Varying symbol size with distance and closer objects obscuring more distant objects are the most easily implemented visual cues. These visual cues have limitations when implemented in a digital display. Symbols can only be made so small before they becomes unrecognizable, yet exaggerating their size to make them more legible

⁶ Track Location Enhancements for Perspective View Displays, SPAWAR TR 1847, December 2000

distorts the appearance of location, making them appear closer than they really are. Closer symbols obscuring symbols that are farther away also makes legibility difficult. Artificial visual cues, not found in the real world but possible on a digital display, such as drop lines and drop shadows (discussed previously), enhance a human's ability to determine the location of an object in a 2.5D display.⁶

K.5.3.3 Direction indicators. In a 2.5D display, the viewing angle is variable, dependent on the viewing position selected by the operator. Typical viewing angles range from 25 to 65 degrees. Unlike map displays, where north is generally displayed oriented to the top of the display, the 2.5D display can be viewed from any direction. In a "fly-through" the viewing direction is changing frequently. There are several methods to provide a visual cue for direction of view, including placing north arrows in the display or showing the heading and attitude in a "heads-up display" type symbol (see figure K-9).

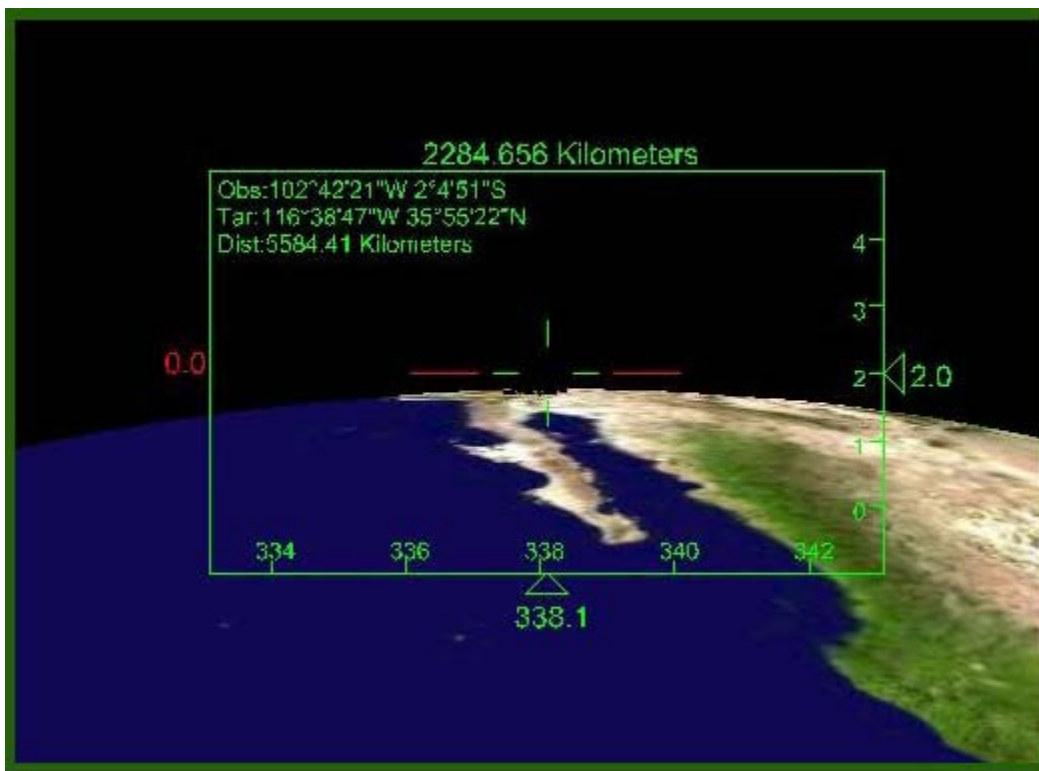

FIGURE K-9. Example of visual cue for direction of view.
(TOC 3D display)

K.5.4 Text amplifiers for symbols. Many symbols in MIL-STD-2525 have text fields around them to present additional information. Text fields for point icons are defined in Figure 3 of MIL-STD-2525. Text fields are also found on the control measure symbols and control measures. Showing text around symbols in a 2.5D display creates a number of difficulties. Perhaps the greatest is the perspective in the display. One of the visual cues to create the impression of three dimensions is to show objects that are farther away in a smaller size; however, reducing symbol size, including text, also reduces legibility. Occultation is another visual cue, in which closer objects obscure more distant objects. Closer objects with text around

them just create a larger “footprint” in the visual plane, potentially obscuring distant symbols or terrain features. Finally, the text will only be visible if there is enough contrast between the text and the background.

K.5.5 Speed vectors and trailing lines. A speed vector is a line extending in front of a symbol or icon, whose length is proportional to the speed of the object. The speed vector is an easy way to symbolize the speed and the heading of the platform. They are generally used on fast-moving platforms such as air tracks. A trailing line is a line showing the track of a platform, indicating where it has been for a period of time in the past. In a 2.5D perspective display, the record of a track of a platform is sometimes enhanced by using drop lines to indicate the position on the terrain surface. Drop lines are sometimes filtered by time to show only a limited trail and to reduce display clutter.

K.5.6 Incomplete data. One of the difficulties facing implementers of 2.5D displays is that sometimes the track data being symbolized may be incomplete. For example, the latitude and longitude of an air track may be known, but the altitude unknown. This is not a great problem in an overhead two-dimensional display, but in a 2.5D display, where should the air track be shown? If the direction of travel is unknown, which direction should be symbolized? The implementer might choose to ignore the missing data (show the air track on the ground) or infer it from other sources. In either case, a warning indicator should be included with the symbol to indicate to the operator that the track has been symbolized based on incomplete information.

K.5.7 Vertical exaggeration of terrain and tactical symbols. In 2.5D displays, the vertical dimension is often exaggerated to highlight variation in the terrain ([see figure K-10](#)). This particular example has a vertical exaggeration of x15. This vertical exaggeration may create distortions in the display, when tactical symbols are also used. For example, if the vertical exaggeration was x3, then the altitude of the air track would also have to be exaggerated by x3 to keep relative position with the terrain.

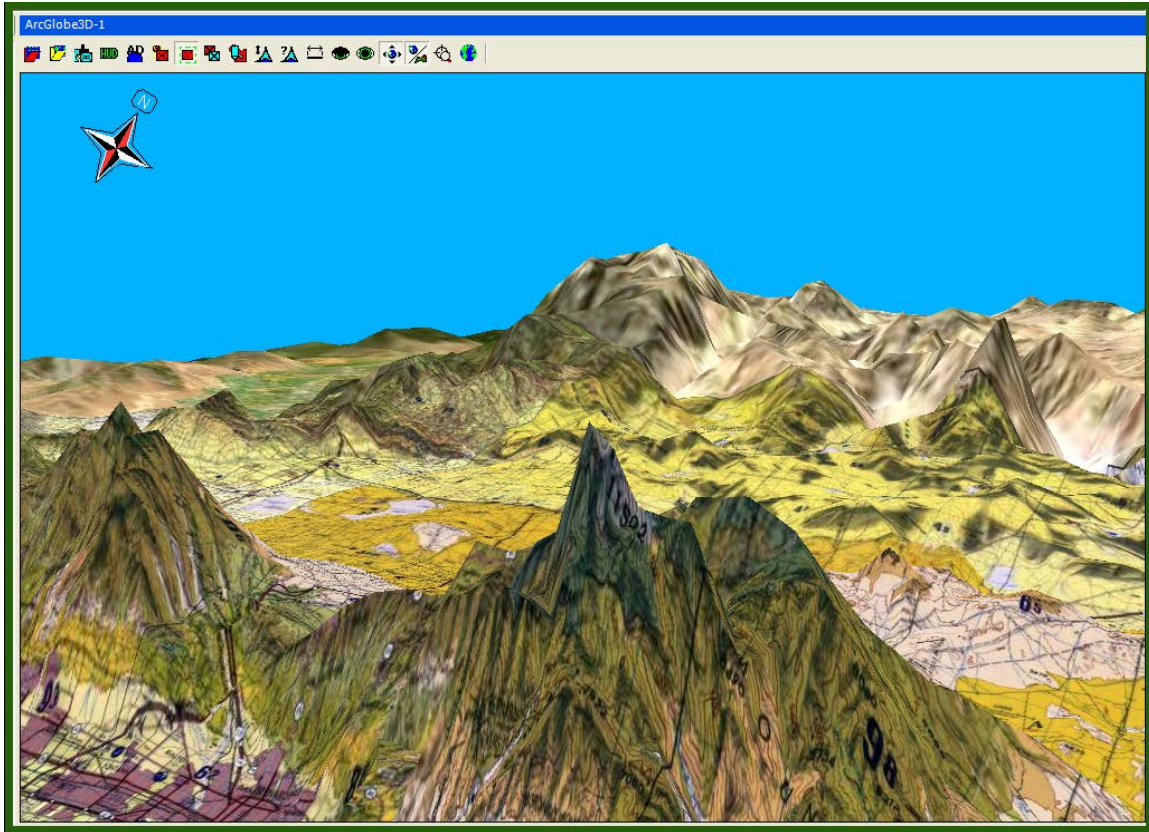

FIGURE K-10. Example of vertical exaggeration.
(TOC 3D display)

K.5.8 Implications for training and doctrine. The use of 2.5D displays in the command and control community is growing. Research into human performance has shown, however, that a 2.5D display is not necessarily the best way to accomplish all tasks. In fact, some tasks are better performed using a conventional “overhead” 2D display or even a conventional map. The types of tasks performed on a C4ISR system should be conducted using a display mode (2D or 2.5D) that best fits the intended task. Operators should be trained to understand which tasks are accomplished best using each display type. User preference often has little bearing on the choice because an operator may like one type of display, even though his/her performance is degraded, compared to other display modes. Some tasks may be accomplished best using a combination of 2.5D to get an overall impression of the situation and 2D views to do the specific locational analysis needed to accomplish the task.

K.6 NOTES

K.6.1 Graphics displayed in this appendix are from the 3D Visualization and Tactical Symbology Considerations for Command, Control, Communications, Computers, Intelligence, Surveillance and Reconnaissance (C4ISR) Applications, Concurrent Technologies Corporation (CTC) White Paper, April 2, 2004.

APPENDIX L - CYBERSPACE SYMBOLS

L.1 SCOPE

L.1.1 Scope. This appendix addresses symbols that support cyberspace in the C2 domain. The tables in this appendix present the icons for the cyberspace domain. This appendix is a mandatory part of the standard. The information contained herein is intended for compliance.

L.2 APPLICABLE DOCUMENTS

Specific documents in [2.2](#) of this standard apply to this appendix.

L.3 DEFINITIONS

The definitions in [section 3](#) of this standard apply to this appendix.

L.4 GENERAL REQUIREMENTS

L.4.1 Organization. This appendix contains technical specifications, a symbol coding scheme, a symbology hierarchy and cyberspace symbology.

L.5 DETAILED REQUIREMENTS

L.5.1 Technical specifications. Composition, construction and display of symbols are explained in the detailed requirements section of the standard.

L.5.2 Symbol identification coding scheme. A symbol identification code (SIDC) is a numeric string that may be used to provide the unique identifier necessary to display or exchange symbol information between MIL-STD-2525 compliant systems. Refer to [Appendix A](#) for SIDC positions and descriptions.

L.5.3 Composition of cyberspace symbols. A standard method for constructing symbols is presented. Refer to [5.3.8](#) for an explanation of symbol composition. [Figure L-1](#) shows an example of a cyberspace symbol.

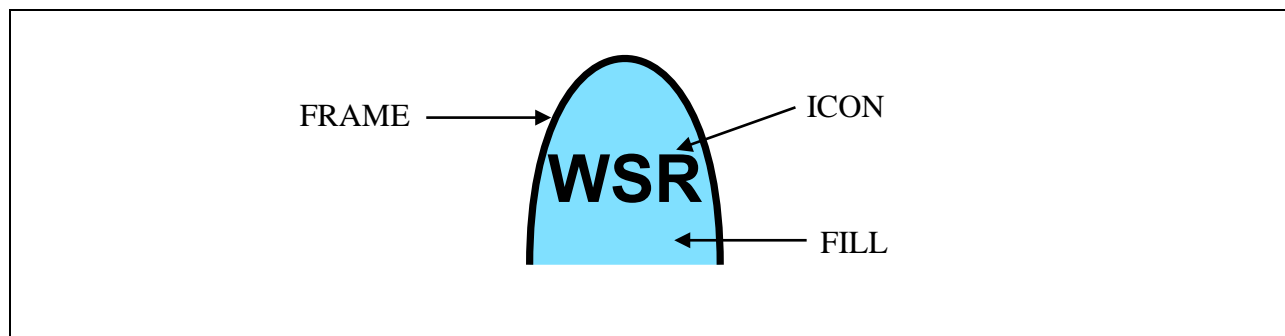
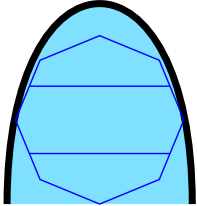

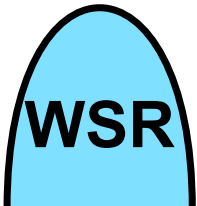

FIGURE L-1. Cyberspace symbol components.

L.5.3.1 Symbol building process. [Table L-I](#) depicts the symbol building process for cyberspace symbols. The process is identical for icons and modifiers requiring the vertical bounding octagon.

TABLE L-I. Cyberspace symbol building process.

STEP	DESCRIPTION	EXAMPLE
1.	<p>Choose the frame that matches the standard identity of the object from the appropriate dimension column in tables I, II, or III. In this example, the standard identity is friend and the dimension is air.</p> <p>The example depicts a “friendly air track.”</p>	
2.	<p>Choose an icon for the main sector of the bounding octagon. In this example, the icon is “web server,” a cyberspace entity type.</p> <p>The example depicts a “friendly air web server.”</p> <p>Note: There are no modifiers in cyberspace symbols.</p>	
3.	<p>The finished symbol will appear as shown in the example.</p>	

L.5.3.2 Icons and modifiers. All icons shall be placed within the main sector of the bounding octagon ([see table L-I](#)). There are no modifiers in cyberspace symbols.

L.5.3.3 Amplifiers. The display of additional alphanumerical and graphical information on identity, movement and location and capabilities of a cyberspace symbol is dependent on the dimension of that symbol. A cyberspace symbol may be in the space, air, land, sea surface, or subsurface dimension. For example, if the cyberspace symbol is in the space dimension, then that symbol shall follow the amplifier requirements as stated in the space appendix. [See 5.1.6](#) for more information on amplifiers.

L.6 CYBERSPACE SYMBOLS

L.6.1 Cyberspace symbols. This section includes the lists of icons and modifiers for building cyberspace symbols.

L.6.2 Cyberspace icons. [Table L-II](#) depicts cyberspace icons.

TABLE L-II. Cyberspace icons.

DESCRIPTION	ICON	REMARKS
BOTNET Type: Entity Symbol Set Code: 60 Code: 110000	N/A	There is no symbol associated with this entity.
COMMAND AND CONTROL (C2) Type: Entity Type Entity: BOTNET Symbol Set Code: 60 Code: 110100		N/A
HERDER Type: Entity Type Entity: BOTNET Symbol Set Code: 60 Code: 110200		N/A
CALLBACK DOMAIN Type: Entity Type Entity: BOTNET Symbol Set Code: 60 Code: 110300		N/A
ZOMBIE Type: Entity Type Entity: BOTNET Symbol Set Code: 60 Code: 110400		N/A
INFECTION Type: Entity Symbol Set Code: 60 Code: 120000	N/A	There is no symbol associated with this entity
ADVANCED PERSISTENT THREAT (APT) Type: Entity Type Entity: INFECTION Symbol Set Code: 60 Code: 120100		N/A

TABLE L-II. Cyberspace icons - Continued.







DESCRIPTION	ICON	REMARKS
APT WITH C2 Type: Entity Subtype Entity/Entity Type: INFECTION/ADVANCED PERSISTENT THREAT (APT) Symbol Set Code: 60 Code: 120101		N/A
APT WITH SELF PROPAGATION Type: Entity Subtype Entity/Entity Type: INFECTION/ADVANCED PERSISTENT THREAT (APT) Symbol Set Code: 60 Code: 120102		N/A
APT WITH C2 AND SELF PROPAGATION Type: Entity Subtype Entity/Entity Type: INFECTION/ADVANCED PERSISTENT THREAT (APT) Symbol Set Code: 60 Code: 120103		N/A
APT OTHER Type: Entity Subtype Entity/Entity Type: INFECTION/ADVANCED PERSISTENT THREAT (APT) Symbol Set Code: 60 Code: 120104		N/A
NON-ADVANCED PERSISTENT THREAT (NAPT) Type: Entity Type Entity: INFECTION Symbol Set Code: 60 Code: 120200		N/A
NAPT WITH C2 Type: Entity Subtype Entity/Entity Type: INFECTION/NON-ADVANCED PERSISTENT THREAT (NAPT) Symbol Set Code: 60 Code: 120201		N/A

TABLE L-II. Cyberspace icons - Continued.







DESCRIPTION	ICON	REMARKS
NAPT WITH SELF PROPAGATION Type: Entity Subtype Entity/Entity Type: INFECTION/NON-ADVANCED PERSISTENT THREAT (NAPT Symbol Set Code: 60 Code: 120202		N/A
NAPT WITH C2 AND SELF PROPAGATION Type: Entity Subtype Entity/Entity Type: INFECTION/NON-ADVANCED PERSISTENT THREAT (NAPT Symbol Set Code: 60 Code: 120203		N/A
NAPT OTHER Type: Entity Subtype Entity/Entity Type: INFECTION/NON-ADVANCED PERSISTENT THREAT (NAPT Symbol Set Code: 60 Code: 120204		N/A
HEALTH AND STATUS Type: Entity Symbol Set Code: 60 Code: 130000	N/A	There is no symbol associated with this entity
NORMAL Type: Entity Type Entity: HEALTH AND STATUS Symbol Set Code: 60 Code: 130100		N/A
NETWORK OUTAGE Type: Entity Type Entity: HEALTH AND STATUS Symbol Set Code: 60 Code: 130200		N/A
UNKNOWN Type: Entity Type Entity: HEALTH AND STATUS Symbol Set Code: 60 Code: 130300		N/A

TABLE L-II. Cyberspace icons - Continued.

DESCRIPTION	ICON	REMARKS
IMPAIRED Type: Entity Type Entity: HEALTH AND STATUS Symbol Set Code: 60 Code: 130400		N/A
DEVICE TYPE Type: Entity Symbol Set Code: 60 Code: 140000	N/A	There is no symbol associated with this entity
CORE ROUTER Type: Entity Type Entity: DEVICE TYPE Symbol Set Code: 60 Code: 140100		N/A
ROUTER Type: Entity Type Entity: DEVICE TYPE Symbol Set Code: 60 Code: 140200		N/A
CROSS DOMAIN SOLUTION Type: Entity Type Entity: DEVICE TYPE Symbol Set Code: 60 Code: 140300		N/A
MAIL SERVER Type: Entity Type Entity: DEVICE TYPE Symbol Set Code: 60 Code: 140400		N/A
WEB SERVER Type: Entity Type Entity: DEVICE TYPE Symbol Set Code: 60 Code: 140500		N/A
DOMAIN SERVER Type: Entity Type Entity: DEVICE TYPE Symbol Set Code: 60 Code: 140600		N/A

TABLE L-II. Cyberspace icons - Continued.

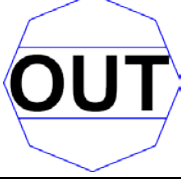



DESCRIPTION	ICON	REMARKS
FILE SERVER Type: Entity Type Entity: DEVICE TYPE Symbol Set Code: 60 Code: 140700		N/A
PEER-TO-PEER NODE Type: Entity Type Entity: DEVICE TYPE Symbol Set Code: 60 Code: 140800		N/A
FIREWALL Type: Entity Type Entity: DEVICE TYPE Symbol Set Code: 60 Code: 140900		N/A
SWITCH Type: Entity Type Entity: DEVICE TYPE Symbol Set Code: 60 Code: 141000		N/A
HOST Type: Entity Type Entity: DEVICE TYPE Symbol Set Code: 60 Code: 141100		N/A
VIRTUAL PRIVATE NETWORK (VPN) Type: Entity Type Entity: DEVICE TYPE Symbol Set Code: 60 Code: 141200		N/A
DEVICE DOMAIN Type: Entity Symbol Set Code: 60, Code: 150000	N/A	There is no symbol associated with this entity
DEPARTMENT OF DEFENSE (DOD) Type: Entity Type Entity: DEVICE DOMAIN Symbol Set Code: 60 Code: 150100		N/A

TABLE L-II. Cyberspace icons - Continued.





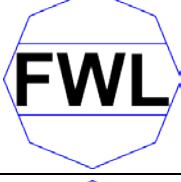
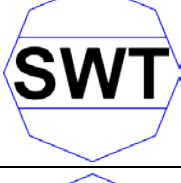
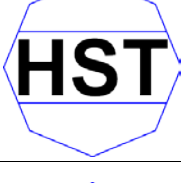





DESCRIPTION	ICON	REMARKS
GOVERNMENT Type: Entity Type Entity: DEVICE DOMAIN Symbol Set Code: 60 Code: 150200		N/A
CONTRACTOR Type: Entity Type Entity: DEVICE DOMAIN Symbol Set Code: 60 Code: 150300		N/A
SUPERVISORY CONTROL AND DATA ACQUISITION (SCADA) Type: Entity Type Entity: DEVICE DOMAIN Symbol Set Code: 60 Code: 150400		N/A
NON-GOVERNMENT Type: Entity Type Entity: DEVICE DOMAIN Symbol Set Code: 60 Code: 150500		N/A
EFFECT Type: Entity Symbol Set Code: 60 Code: 160000	N/A	There is no symbol associated with this entity
INFECTION Type: Entity Type Entity: EFFECT Symbol Set Code: 60 Code: 160100		N/A
DEGRADATION Type: Entity Type Entity: EFFECT Symbol Set Code: 60 Code: 160200		N/A
DATA SPOOFING Type: Entity Type Entity: EFFECT Symbol Set Code: 60 Code: 160300		N/A

TABLE L-II. Cyberspace icons - Continued.

DESCRIPTION	ICON	REMARKS
DATA MANIPULATION Type: Entity Type Entity: EFFECT Symbol Set Code: 60 Code: 160400		N/A
EXFILTRATION Type: Entity Type Entity: EFFECT Symbol Set Code: 60 Code: 160500		N/A
POWER OUTAGE Type: Entity Type Entity: EFFECT Symbol Set Code: 60 Code: 160600		N/A
NETWORK OUTAGE Type: Entity Type Entity: EFFECT Symbol Set Code: 60 Code: 160700		N/A
SERVICE OUTAGE Type: Entity Type Entity: EFFECT Symbol Set Code: 60 Code: 160800		N/A
DEVICE OUTAGE Type: Entity Type Entity: EFFECT Symbol Set Code: 60 Code: 160900		N/A

PAGE INTENTIONALLY LEFT BLANK

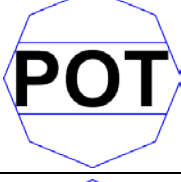
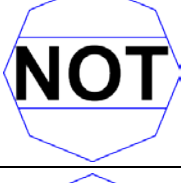
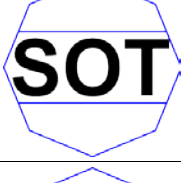
INDEX

Abatis	582
Above Ground Shelter	604
Accident	214, 228, 385
Acoustic Countermeasure (Decoy)	477
Acoustic Fix	481
Acronyms	3
Action Area	416
Action Points (General)	401
Active Maneuver Area	473
Activities Symbols	353
Administrative	193
Adult Day Care	287
Advanced Persistent Threat (APT)	801
AEW Station	461
Aftershock	379
Agriculture and Food Infrastructure	277
Agriculture Laboratory	277
Aids to Navigation	740
Aim Point	474
Air	160, 161, 378
Air Assault with Organic Lift	175
Air Control Point	460
Air Control Rendezvous	461
Air Corridor	448
Air Corridor with Multiple Segments	449
Air Cushioned	323
Air Defense	182
Air Defense Gun - Heavy	232
Air Defense Gun - Light	232
Air Defense Gun - Medium	232
Air Defense Guns	231
Air Defense Missile Launcher	236
Air Defense Missile Launcher - Heavy	238
Air Defense Missile Launcher – Heavy, TLAR	238
Air Defense Missile Launcher - Light	236
Air Defense Missile Launcher – Light, TELAR	237
Air Defense Missile Launcher – Light, TLAR	236

MIL-STD-2525D - INDEX

Air Defense Missile Launcher - Medium	237
Air Defense Missile Launcher – Medium, TELAR	237
Air Defense Missile Launcher – Medium, TLAR	237
Air Detonation	476
Air Independent Propulsion	336
Air Mobile/Air Assault	206
Air Symbols	141
Air Traffic Control	774
Air Traffic Facility	289
Air Traffic Services/Airfield Operations	175
Air Transportable Communication (ATAC)	484
Air/Land Naval Gunfire Liaison	183
Airborne	216
Airborne Command Post (ACP)	147, 154
Airborne Early Warning (AEW)	147, 154
Airborne Intercept	774
Airborne Reconnaissance and Mapping	774
Airborne Search and Bombing	774
Aircraft Production/Assembly	270
Airfield (AEGIS Only)	409
Airfield Zone	400
Airhead Line	445
Airport of Debarkation/Airport of Embarkation	194
Airport/Air Base	289
Airship	150, 151
Airspace Control (Corridors) Areas	448
Airspace Control Lines	465
Airspace Control Points	459
Airspace Coordination Area (ACA)	507
Airspace Coordination Area (ACA) - Irregular	508
Airspace Coordination Area (ACA) – Circular	510
Airspace Coordination Area (ACA) - Rectangle	509
Air-to-Air Restricted Operations Zone (AARROZ)	454
All Classes of Supply	193
Allied Command Europe Rapid Reaction Corps (ARRC)	202
Allied Command Operations	202
Alternate Decontamination Point/Site	612
Alternate Supply Route (ASR)	635

MIL-STD-2525D - INDEX

Alternating Traffic	634, 635
Altimeter	774
Ambient Noise Sonobuoy	484
Ambulance	268
Ambulance Exchange Point	616
Ambush	447
Ammunition	194
Ammunition and Explosive/Production	270
Ammunition Cache	270
Ammunition Ship	311
Ammunition Supply Point	616
Ammunition Transfer Point	617
Amnesty Point	401
Amphibious	27, 176, 177, 178
Amphibious Assault Ship, General	305
Amphibious Assault Ship, Helicopter	306
Amphibious Assault Ship, Multipurpose	305
Amphibious Assault, Non-specified	305
Amphibious Command Ship	305
Amphibious Transport Dock	306
Amphibious Utility Wheeled Vehicle	254
Amphibious Warfare Ship	305
Amplifier	3
Amplifiers	19
Analysis	190, 191
Anchorage - Area	734
Anchorage - Line	734
Anchorage - Ports	734
Animal Feedlot	277
Antennae	264
Antiair Warfare	319
Anti-Aircraft Fire Control	774
Anti-Ballistic	160
Anticyclone Center	661
Antipersonnel Land Mine (APL)	266
Antipersonnel Mine	593
Antipersonnel Mine with Directional Effects	594
Antisatellite Weapon	132

MIL-STD-2525D - INDEX

Antisubmarine Warfare	147, 155, 215, 319, 334
Antisubmarine Warfare (ASW) Surface Station	492
Antisubmarine Warfare (ASW) Unmanned Underwater Vehicle Subsurface Station	491
Antisubmarine Warfare (ASW) Unmanned Underwater Vehicle Surface Station	493
Antisubmarine Warfare, Rotary Wing	462
Antisurface Warfare	147, 156
Antitank Ditch – Completed	584
Antitank Ditch – Under Construction	584
Antitank Ditch Reinforced, with Antitank Mines	585
Antitank Gun	232
Antitank Gun - Heavy	233
Antitank Gun - Light	232
Antitank Gun - Medium	233
Antitank Mine	267, 594
Antitank Mine with Anti-handling Device	594
Antitank Missile Launcher	238
Antitank Missile Launcher - Heavy	239
Antitank Missile Launcher - Light	238
Antitank Missile Launcher - Medium	239
Antitank Obstacles	583
Antitank Rocket Launcher	242
Antitank Rocket Launcher - Heavy	243
Antitank Rocket Launcher - Light	243
Antitank Rocket Launcher - Medium	243
Antitank Wall	586
Antitank/Antiarmor	176
Anti-torpedo Torpedo	336
Appendix A	45
Appendix B	127
Appendix C	141
Appendix D	165
Appendix E	299
Appendix F	327
Appendix G	353
Appendix H	387
Appendix I	659
Appendix J	771
Appendix K	783

MIL-STD-2525D - INDEX

Appendix L	799
APT Other	802
APT with C2	802
APT with C2 and Self Propagation	802
APT with Self Propagation	802
Arctic	216
Area	4, 206, 414
Area of Operations	399
Area of Uncertainty Amplifier	30
Area Target	527
Area Targets	527
Areas	391
Armament Production	270
Armor/Armored/Mechanized/Self-Propelled/Tracked	176
Armored	176, 244
Armored Assault	251
Armored Carrier with Volcano	250
Armored Engineer Recon Vehicle (AERV)	251
Armored Fighting Vehicle	244
Armored Fighting Vehicle Command and Control	244
Armored Personnel Carrier	244
Armored Personnel Carrier Ambulance	245
Armored Personnel Carrier, Recovery	245
Armored Protected Vehicle	245
Armored Protected Vehicle Medical Evacuation	245
Armored Protected Vehicle Recovery	245
Armored/Mechanized/Tracked	179, 184
Army Aviation/Aviation Rotary Wing	177, 178
Arrest	357
Arrow	139
Arson	357
Artillery Target Intelligence Zone (ATI)	537
Artillery Target Intelligence Zone (ATI), Circular	540
Artillery Target Intelligence Zone (ATI), Irregular	538
Artillery Target Intelligence Zone (ATI), Rectangular	539
Assassination	225, 383
Assault Crossing	600
Assault Position.	438

MIL-STD-2525D - INDEX

Assembly Area (AA)	415
Assumed Friend	4
Astronomical Satellite	132, 134
ASW (Helo and F/W) Station	461
ASW Helo - LAMPS	157
ASW Helo – SH-60R	157
ATM	279
Atomic Energy Reator	296
Attack	206, 222, 335
Attack By Fire Position	442
Attack Helicopter	429
Attack Position	438
Attack/Strike	145, 152
Attempted	384
Attempted Criminal Activity	357
Attribute	4
Automatic Rifle	229
Automobile	255
Autonomous Control	324, 338
Autonomous Underwater Vehicle (AUV)/Unmanned Underwater Vehicle (UUV)	332, 333
Auxiliary	334
Auxiliary Flag Ship	311
Auxiliary Ship	310
Avalanche	379
Aviation	215
Aviation Composite	177
Aviation Fixed Wing	178
Axis of Advance	428
Axis of Advance for a Feint	431, 506
Backhoe	251
Ballistic	138, 160
Ballistic Missile	321, 335
Ballistic Missile Defense, Long-Range Surveillance and Track (LRS&T)	322
Ballistic Missile Defense, Shooter	321
Band	194
Bank	279
Banking Finance and Insurance Infrastructure	278
Barge	27

MIL-STD-2525D - INDEX

Barge, Not Self-Propelled	313, 317
Barge, Self-Propelled	314
Barra	484
Barrage Jammer	777
Base Defense Zone.	452
Bathythermograph Transmitting Sonobuoy (BT)	485
Battle Damage Repair	216
Battle Position	420
Battle Position Planned	420
Battle Position Prepared (P) but not Occupied	420
Battlefield Coordination Line	523
Battlefield Surveillance	775
Battleship	303
Beach	732
Beach Slope	754
Beach Slope, Flat	754
Beach Slope, Gentle	754
Beach Slope, Moderate	755
Beach Slope, Steep	755
Beacon	740, 774
Bearing Box AOU Amplifier	30
Bearing Line	501
Bearing Line, Acoustic	502
Bearing Line, Acoustic (Ambiguous)	503
Bearing Line, Electronic	501
Bearing Line, Electronic Warfare	502
Bearing Line, Electro-Optical Intercept	503
Bearing Line, Jammer	504
Bearing Line, Torpedo	503
Below Ground Shelter	604
Belts and Strips	719
Bergy Bit	720
Bergy Water	721
Berths (Anchor)	734
Berths (Onshore)	733
Bicycle Equipped	216
Billboarding	783
Biological	206, 268, 294

MIL-STD-2525D - INDEX

Biological – Toxic Industrial Material	610
Biological Contaminated Area	606
Biological Contaminated Area – Toxic Industrial Material	606
Biological Event	610
Biological Warfare Production	296
Bioluminescence	751
Biosatellite	132, 134
Bird	381
Black List Location	270
Black Marketing	359
Block	575, 636
Blowing Dust or Sand	704
Blowing Snow – Heavy	695
Blowing Snow - Light/Moderate	695
Blue Kill Box, Circular	570
Blue Kill Box, Irregular	568
Blue Kill Box, Rectangular	569
Bomb	152, 264, 361
Bomb Area	532
Bomb Explosion	364
Bomb Threat	361
Bomber	145, 153
Bombing	361
Booby Trap	264, 359, 595
Boom and Drogue	158
Boom-Only	158
Border	206
Border Patrol	203, 261, 274, 371
Botnet	801
Bottom Features	746
Bottom Features - Clay	747
Bottom Features - Cobbles	748
Bottom Features - Coral	749
Bottom Features - Gravel	748
Bottom Features - Mud	747
Bottom Features - Pebbles	748
Bottom Features - Rock	748
Bottom Features - Sand	746

MIL-STD-2525D - INDEX

Bottom Features - Shell	749
Bottom Features - Silt	747
Bottom Features - Stones	747
Bottom Return/ Non-Mine, Mine-Like Bottom Object (NOMBO)	499
Bottom Return/ Non-Mine, MineLike Bottom Object (NOMBO)/Installation/Manmade	499
Bottom Return/Non-MILCO, Wreck, Dangerous	500
Bottom Return/Non-MILCO, Wreck, Non Dangerous	501
Bottom Roughness - Moderate	760
Bottom Roughness - Rough	760
Bottom Roughness - Smooth	760
Bottom Sediments - Solid Rock	755
Boundary	4, 396
Bounded Areas of Weather	707
Breach	637
Breakers	745
Breakwater/Groin/Jetty - Above Water	739
Breakwater/Groin/Jetty - Below Water	740
Bridge	247, 271, 601
Bridge Mounted on Utility Vehicle	248
Bridge or Gap	579
Bridgehead Line (BL)	445
Bridging	206
Brief Contact	478
Brigade Support Area (BSA)	631
Broadcast	201
Broadcast Transmitter Antennae	173, 174, 288
Broken Coverage	686
BT Buoy Drop	479
Bullion Storage	279
Buoy Default	741
Bureau of Alcohol, Tobacco, Firearms and Explosives (ATF)	203, 261, 274, 371
Burglary	360
Bus	252
Bus Station	289
Bypass	637
C2	4
Cable Ferry Crossing	739
Call For Fire Zone (CFFZ)	540

MIL-STD-2525D - INDEX

Call For Fire Zone (CFFZ), Circular	543
Call For Fire Zone (CFFZ), Irregular	541
Call For Fire Zone (CFFZ), Rectangular	542
Call in Point	735
Callback Domain	801
Calm Winds	683
Canal	768
Canalize	638
Cannibalization Point	617
CAP Station	461
Capsule	131, 134
Cargo	146, 153
Cargo, General	314
Carrier	303
Casualty Collection Point	617
Casualty Staging	216
Cave Entrance	380
CBRN	271
CBRN Equipment	264
CBRN Events	391
CBRN Observation Outpost	425
Cellular/Mobile	775
Censor Zone	543
Censor Zone, Circular	546
Censor Zone, Irregular	544
Censor Zone, Rectangular	545
Center of Main Effort	402
Certain Submarine	336
Checkpoint	402
Chemical	206, 269, 294
Chemical – Toxic Industrial Material	610
Chemical Agent	375
Chemical Biological Radiological Nuclear Defense	185
Chemical Contaminated Area	606
Chemical Event	609
Chemical Plant	280
Chemical Warfare Production	296
Chemically Contaminated Area – Toxic Industrial Material	606

MIL-STD-2525D - INDEX

Child Day Care	287
Circular Target	529
Civil Affairs	173
Civil Disturbance	364
Civil Rioting	359
Civilian	134, 151, 215, 223, 226, 269, 295, 314, 332
Civilian Collection Point	618
Civilian Telephone	295
Civilian Television	295
Civilian Vehicle	255
Civil-Military Cooperation	173
Clear	639
Clear Icing	679
Clear Icing, Light	680
Clear Icing, Moderate	680
Clear Icing, Severe	680
Clear Sky	686
Clearing	216
Click Jammer	777
Close Protection	206
Close Range	158, 216
Cloud Coverage	685
Cloud Coverage Symbols	685
Clutter (Bottom) - High	761
Clutter (Bottom) - Low	760
Clutter (Bottom) - Medium	761
Clutter, Stationary or Cease Reporting	496
Coal	295
Coast Guard	204, 262, 276, 373
Coastal Hydrography	731
Coastal Surveillance	775
Coastline	732
Coerced/Impressed	365
Coerced/Impressed Recruit	227
Cold Front	662
Cold Frontogenesis	663
Cold Frontolysis	664
College	283

MIL-STD-2525D - INDEX

Color	40
Combat	178, 207, 228
Combat Outpost	426
Combat Search and Rescue	223
Combat Search and Rescue (CSAR)	148, 156
Combat Service Support	194
Combat Service Support Vehicle	246
Combat Support (Maneuver Enhancement)	186
Combat Support Ship, Fast	312
Combined Arms	178
Command Active Multi-Beam Sonobuoy (CAMBS)	485
Command Active Sonobuoy Directional Command Active Sonobuoy System (CASS)	485
Command and Control	172, 207, 334
Command and Control (C2)	801
Command and Control Areas	399
Command and Control Lines	396
Command and Control Points	401
Command Launch Equipment (CLE)	264
Commercial Food Distribution Center	277
Commercial Infrastructure	280
Communications	148, 155, 773
Communications Check Point	460
Communications Contingency Package	207
Communications Satellite	132, 134
Compact	255
Compact or Wet Snow (With or Without Ice) Covering at Least One-Half Ground, but Ground Not Completely Covered	716
Compact or Wet Snow (With or Without Ice) Covering Less Than One-Half of Ground	716
Completed Minefield	589
Composite Loss	224
Computer System	264
Construction	207
Construction Vehicle	251
Contact Point	402
Contain	422
Container Ship	315
Contaminated Hazardous Waste Site	282
Continuous Light	688

MIL-STD-2525D - INDEX

Contour - Upper Air	711
Contractor	806
Control	217
Control Measures Symbols	387
Control Valve	292
Controlled Approach	775
Controlled Intercept	775
Convergence Line	673
Convergence	722
Convoy	310
Coordinated Fire Line (CFL)	522
Coordinating Point	403
Core Router	804
Corps Support	205
Corridor Tab Point	488
Corrosive Material	375
Corvette	304
Counterattack	640
Counterattack by Fire	640
Counterintelligence	191
Cover	651
Cracks	727
Cracks at a Specific Location	727
Crane/Loading Device	263
Criminal Activity Incident	357
Criminal Investigation Division	186
Critical Friendly Zone (CFZ)	546
Critical Friendly Zone (CFZ), Circular	549
Critical Friendly Zone (CFZ), Irregular	547
Critical Friendly Zone (CFZ), Rectangular	548
Cross Cultural Communication	207
Cross Domain Solution	804
Cross-Country Truck	254
Crowd and Riot Control	207
Cruise	160
Cruiser	304
Cubing	783
Cued Acquisition Doctrine	473

MIL-STD-2525D - INDEX

Current Flow - Ebb	750
Current Flow - Flood	750
Curve (line)	783
Customs Service	203, 261, 274, 371
Cyberspace Symbols	799
Cyclone Center	660
Dam	292
Dangers/Hazards	743
Data Link Reference Point	488
Data Manipulation	807
Data Spoofing	806
Data Transmission	775
Datum Lost Contact	478
Dead Body	360
Dead Reckoning Trailer Amplifier	30
Dead Space Area	549
Dead Space Area, Circular	552
Dead Space Area, Irregular	550
Dead Space Area, Rectangular	551
Deception	504
Deceptive Jammer	777
Decision Point	403
Decontamination	207, 217, 294
Decoy	152, 308, 333
Decoy Mined Area	506, 592
Decoy Mined Area, Fenced	593
Decoy/Dummy	505
Decoy/Dummy and Feint	506
Decoy/Mimic	775
Defended Area	4, 467
Defended Area, Ellipse/Circle	468
Defended Area, Rectangle	469
Defended Asset	474
Definitions	3
Degradation	806
Delay	641
Demolition	217
Demonstration	364

MIL-STD-2525D - INDEX

Dental	217
Department of Defense (DoD)	805
Department of Justice (DOJ)	203, 261, 275, 372
Depth	730
Depth Area	731
Depth Contour	731
Depth Curve	731
Destroy	642
Destroyer	304
Detainee Collection Point	618
Detainee Holding Area	629
Detention	207
Device Domain	805
Device Outage	807
Device Type	804
Diesel – Type 1	337
Diesel – Type 2	337
Diesel – Type 3	337
Diesel Electric, General	337
Digital	217
Dip Position	483
Direct Communications	208
Direct Fire Gun	233
Direct Fire Gun - Heavy	234
Direct Fire Gun - Light	233
Direct Fire Gun - Medium	233
Direction Finding	191
Direction of Attack	432
Direction of Attack for a Feint	433, 506
Directional Command Active Sonobuoy System (DICASS)	485
Directional Frequency Analyzing and Recording (DIFAR)	485
Discharge Outfall	292
Discolored Water	746
Displaced Person(s), Refugee(s) and Evacuee(s)	226
Displaced Persons/ Refugee/Evacuees Camp	273
Disrupt	643
Disrupt	576
Distress Call	403

MIL-STD-2525D - INDEX

Distressed Vessel	497
Ditched Aircraft/Downed Aircraft	497
Dive Report Location	352
Diver	332, 333
Divergence	723
Diversion Route	495
Diving	187, 208
Division	208
Division Support Area	631
Dock	323
Dog	187, 208
Dolphin	739
Domain Server	804
Double Apron Fence	587
Double Fence	586
Double Strand Concertina	587
Downed Aircrew Pick-Up Pont	460
Downlinked	159
Dozer	251
Dozer, Armored	251
Dredge	315
Dredger	318
Drifter	317
Drill	248
Drill Mounted on Utility Vehicle	249
Drilling	187, 208
Drive-By Shooting	358
Drizzle	690
Drogue-Only	158
Drone Equipped	321
Drop Point	475
Drop Zone (DZ)	417
Drought	381
Drug Enforcement Administration (DEA)	371
Drug Enforcement Agency (DEA)	203, 261, 274
Drug Related	358
Drug Vehicle	260
Drydock	736

MIL-STD-2525D - INDEX

Dummy Minefield	506, 590
Dummy Minefield, Dynamic	590
Dust Devil	704
Dust or Sand	703, 709
Dynamic Amplifier	4
Dynamic Depiction	591
Dynamic Graphic Amplifiers	28
Dynamic Processes	722
Dynamic Towed Sensor Array Amplifier	31
Early Warning	776
Early Warning Radar	269
Earth Observation Satellite	132, 135
Earth Surveillance	775
Earthmover	249
Earthquake Epicenter	379
Echo Tracker Classifier (ETC)/Possible Contact (POSCON)	339
Economic Infrastructure Asset	279
Eddies/Overfalls/Tide Rips	746
Educational Facilities Infrastructure	282
Effect	806, 807
Elder Care	288
Electric Power	283
Electromagnetic - Magnetic Anomaly Detection (MAD)	481
Electromagnetic Fix	481
Electronic Attack (EA)	150, 157
Electronic Combat (EC)/Jammer	146, 154
Electronic Countermeasures (ECM) Decoy	478
Electronic Ranging	191
Electronic Support (ES)	148, 155
Electronic Warfare	191, 320
Electro-Optical	208
Ellipse AOU Amplifier	30
Emergency Collection Evacuation Point	367
Emergency Food Distribution	367
Emergency Incident Command Center	367
Emergency Medical Operation	225, 266, 276, 369
Emergency Operation	202, 268, 276, 367
Emergency Operations Center	368

MIL-STD-2525D - INDEX

Emergency Public Information Center	368
Emergency Shelter	368
Emergency Staging Area	368
Emergency Water Distribution Center	368
EMT Station Location	369
Encirclement	440
Enclosed Facility (Public Venue)	286
Enemy	441
Enemy Confirmed	431, 433
Enemy Known	411
Enemy Known Boundary	395
Enemy Known or Confirmed Area	415
Enemy Point	489
Enemy Prisoner of War (EPW) Collection Point	618
Enemy Prisoner of War Holding Area	629
Enemy Suspected Area	415
Enemy Suspected or Templated	412
Enemy Suspected or Templated Boundary	395
Enemy Templated or Suspected	432, 433
Energy Facilities Infrastructure	283
Engagement Area (EA)	424
Engineer	187
Engineer Equipment Production	271
Engineer Regulating Point	602
Engineer Vehicles and Equipment	247
Enhanced	208
Enhanced Position Location Reporting System (EPLRS)	217
Entry Control Point	404
Entry Point	475
Environmental Protection	223
Environmental Report Location	352
Equipment	217
Equipment Decontamination Point/Site	613
Equipment Manufacture	271
Equipment/Troop Decontamination Point/Site	613
Escort	150, 154, 319
Estimated Ice Edge or Boundary	726
Estimated Position (EP)	489

MIL-STD-2525D - INDEX

Even Layer of Compact or Wet Snow Covering Ground Completely	716
Even Layer of Loose Dry Snow Covering Ground Completely	717
Evolved Sea Sparrow Missile (ESSM)	162
Execution (Wrongful Killing)	225, 383
Exercise Mine, Bottom	341
Exercise Mine, Floating	342
Exercise Mine, General	341
Exercise Mine, Moored	342
Exercise Mine, Rising	342
Exfiltration	366, 807
Expendable	324, 338
Expendable Reliable Acoustic Path Sonobuoy (ERAPS)	486
Experimental	782
Expired Sonobuoy	486
Explosion	363
Explosive Material	375
Explosive Ordnance Disposal (EOD)	188, 208
Explosives, State of Readiness 1 (Safe)	580
Explosives, State of Readiness 2 (armed but passable)	581
Extortion	358
Extraction Zone (EZ)	418
Extremely Dry with Cracks	715
Facilities	736
Fall	677
Fall Then Rise Lower	676
Fall Then Steady	676
False	384
Farm/Ranch	277
Farthest-On Circle DR Trailer Amplifier	30
Fast	323
Federal Bureau of Investigation (FBI)	204, 261, 275, 372
Federal Reserve Bank	279
Ferry	315, 602
Ferry Crossing	738
Ferry Terminal	289
Ferry Transporter	252
Few Coverage	686
Field	5

MIL-STD-2525D - INDEX

Field Artillery	183
Field Artillery Observer	183
Field Camp Construction	188
Fighter	145, 153
Fighter Engagement Zone (FEZ)	456
Fighter/Bomber	146, 156
File Server	805
Final Coordination Line	434
Final Protective Fire (FPF)	527
Finance	194
Financial Exchange	280
Find	384
Fire Areas	507
Fire Control	776
Fire Direction Center	209
Fire Event	373
Fire Fighting Operation	370
Fire Fighting/Fire Protection	188, 268
Fire Hydrant	370
Fire Lines	521
Fire Origin	373
Fire Station	276, 370
Fire Support Area	533
Fire Support Area - Circular	535
Fire Support Area - Irregular	533
Fire Support Area - Rectangular	534
Fire Support Coordination Line (FSCL)	521
Fire Support Station	532
Firearms Manufacture	280
Firearms Retailer	281
Fires	182
Fires Points	535
Firewall	805
Firing Point	535
Fish Stakes - Point	736
Fish Traps - Area	736
Fish Weirs - Point	735
Fishing Harbor - Point	735

MIL-STD-2525D - INDEX

Fishing Vessel	317
Fix	577, 644
Fixed and Prefabricated	596
Fixed Bridge	248
Fixed-Wing	145, 151
Fixed-Wing MISO	181
Flame Thrower	231
Flammable Gas	376
Flammable Liquid	376
Flammable Solid	376
Floating Bridge	248
Floeberg	721
Flood	381
Fly-To-Point	404
Fly-To-Point (Normal)	405
Fly-To-Point (Sonobuoy)	404
Fly-To-Point (Weapon)	404
Fog	700, 709
Folding Girder Bridge	248
Follow and Assume	644
Follow and Support	645
Food Distribution	278
Food Production Center	278
Food Retail	278
Foraging/Searching	365
Force	209
Ford	768
Ford Difficult	601
Ford Easy	601
Foreign Fighter(s)	226
Foreshore - Area	733
Foreshore - Line	733
Formation	482
Fort	604
Fortified Area.	419
Fortified Line	605
Fortified Position	605
Forward	209

MIL-STD-2525D - INDEX

Forward Arming and Refueling Point (FARP)	630
Forward Boundary	396
Forward Edge of the Battle Area	413
Forward Line of Troops	410
Forward Observer / Spotter Position	488
Forward Observer Outpost/Position	425
Forward Troop Decontamination Point/Site	615
Foul Ground - Area	744
Foul Ground - Point	744
Found and Cleared	384
Frame	5
Free Fire Area (FFA)	510
Free Fire Area (FFA) – Circular	513
Free Fire Area (FFA) - Irregular	511
Free Fire Area (FFA) – Rectangle	512
Freezing Drizzle	692
Freezing Drizzle, Light	692
Freezing Drizzle, Moderate/Heavy	692
Freezing Level	706
Freezing Rain	689
Freezing Rain, Light	689
Freezing Rain, Moderate/Heavy	689
Freezing, Sky Not Visible	702
Freezing, Sky Visible	702
Freezing/Frozen Precipitation	708
Frequency Swept Jammer	777
Friend	5
Friendly	440
Friendly Airborne/Aviation	428
Friendly Area	414
Friendly Aviation	432
Friendly Direction of Main Attack	433
Friendly Direction of Supporting Attack	433
Friendly Ground Axis Planned or On Order with Effective Date and Time	433
Friendly Planned or On Order	411
Friendly Planned or On Order Area	415
Friendly Planned or On Order Boundary	395
Friendly Present	410

MIL-STD-2525D - INDEX

Friendly Present Boundary	395
Frigate	304
Frontal Systems	662
Frozen Lead	728
Funnel Cloud (Tornado/Waterspout)	700
Fused Track	325, 339
Gang Member or Gang	226
General Decontamination Point/Site	612
General Mine Anchor	351
General Route	494
General Subsurface Station	490
General Supply Point	623
General Surface Station	492
Generation Station	283
Generator Set	264
Geologic	379
Geophysics/Acoustics	755
Geospatial	783
Geospatial Support/Geospatial Information Support	188
Geostationary Orbit (GO)	136
Geosynchronous Orbit (GSO)	136
Geothermal	295
Glaze (Thin Ice) on Ground	714
Glyph	783
Government	148, 154, 806
Government Leadership	271
Government Organization	223, 226
Govrnmnt Site Infrastructure	284
Graffiti	358
Grain Storage	278
Graphic	5
Gray List Location	271
Grenade Explosion	363
Grenade Launcher	230
Grenade Launcher - Heavy	231
Grenade Launcher - Light	231
Grenade Launcher - Medium	231
Ground	181

MIL-STD-2525D - INDEX

Ground Mapping	776
Ground Station Module	209
Ground Water Well	292
Ground Zero	476
Ground-Based Interceptor (GBI)	139
Ground-based Midcourse Defense (GMD) Fire Control (GFC) Center	265
Growler	720
Guard	652
Guided Missile	321, 335
Hail	696
Halted Convoy	633
Harbor	482
Harbor Entrance Point	482
Harbor Surveillance	776
Hazardous Material Production	281
Hazardous Material Storage	281
Hazardous Materials	375
Hazardous Materials Incident	375
Hazardous When Wet	375
Haze	703
Headquarters Element	205
Health and Status	803
Health Department Facility	369
Heavy	158, 217, 322
Heavy Lift	315
Height Finding	776
Helicopter Equipped/VSTOL	321
Helicopter Landing Site	290
Herder	801
Hide Point	536
High Altitude	218
High Earth Orbit (HEO)	136
High Pressure Center	661
High to Low Altitude	222
High to Medium Altitude	219
High Wire Fence	587
High-Density Airspace Control Zone	453
Hijacking	157, 225, 269

MIL-STD-2525D - INDEX

Hijacking/Hijacked	322, 336, 383
HIMEZ	457
Hoax (Decoy)	384
Holding Line (HL)	446
Hollow Deck Bridge	248
Home Eviction	359
Hospital Ship	312, 317
Host	805
Hostile	5
Hot Spot	374
House-to-House	383
Hovercraft	315
Howitzers	235
Howitzers - Heavy	235
Howitzers - Light	235
Howitzers - Medium	235
Hurricane/Typhoon	705
Hydroelectric	295
Hydrofoil	324
Hydrography	730
Hydro-Meteorological	380
Ice Concentration	721
Ice Crystals (Diamond Dust)	697
Ice Drift (Direction)	723
Ice Edge or Boundary From Radar	726
Ice Free	722
Ice Island	721
Ice Pellets (Sleet)	697
Ice Pellets (Sleet), Heavy	698
Ice Pellets (Sleet), Light	697
Ice Pellets (Sleet), Moderate	698
Ice Systems	718
Ice Thickness (Estimated)	724
Ice Thickness (Observed)	724
Iceberg	498
Icebergs	718
Icebergs, General	719
Icing	679, 708

MIL-STD-2525D - INDEX

Icon	5, 783
Icon-based symbol	5
Identification, Friend or Foe (Interrogator)	776
Identification, Friend or Foe (Transponder)	777
Identification, Friend-or-Foe (IFF) Off Line	465
Identification, Friend-or-Foe (IFF) On Line	465
IED Cache	362
IED Event	361
IED Explosion	361
IED Suicide Bomber	362
Illegal Drug Lab	363
Illegal Drug Operation	362
Image	784
Impact Burial - >75%	762
Impact Burial - 0%	761
Impact Burial – 0-10%	761
Impact Burial – 10-20%	762
Impact Burial – 20-75%	762
Impact Point	476
Impaired	804
Improvised Explosive Device (IED)	267, 333
Incendiary Explosion	363
Incident	357, 385
Individual	224, 382
Industrial Site	281
Infantry	178
Infantry Fighting Machine	179
Infection	801, 806
Infestation	381
Infiltration	366
Infiltration Lane	435
In-Flight Interceptor Communications System (IFICS) Data Terminal (IDT)	265
Information Operations	173
Infrared	137
Infrastructure	277
Insect	381
Instability Line	671
Installation	5, 270

MIL-STD-2525D - INDEX

Instrument Flight Rule (IFR)	707
Instrument Landing System	776
Instrumentation	780
Intelligence	190
Intelligence Collector	311
Intelligence Coordination Line (ICL)	656
Intelligence Lines	656
Intelligence, Surveillance, Reconnaissance	320, 334
Intensive Care	157, 218
Intercept	192
Intercept (Search and Recording)	192
Interceptor	138, 153, 160
Intercontinental	139, 163
Interdict	645
Intermediate Range	139, 162
Intermittent Heavy	688, 691, 695
Intermittent Heavy/Continuous Heavy	689, 692, 695
Intermittent Light	687, 690, 694
Intermittent Light/Continuous Light	691, 694
Intermittent Moderate	688, 691, 694
Intermittent Moderate/Continuous Moderate	688, 691, 694
Intermodal	218
Internal Security Force	205, 373
International Security Assistance Force (ISAF)	202
Interoperability	5
Interrogation	192
Inter-Tropical Convergence Zone	672
Inter-Tropical Discontinuity	673
Intrusion	269
Inversion	698
Ionospheric Sounding	776
Island	732
Isobar – Surface	710
Isodrosotherm	712
Isolate	646
Isopleths	710
Isotach	711
Isotherm	711

MIL-STD-2525D - INDEX

Jail Break	359
Jammed Brash Barrier	730
Jammer	773
Jammer (general)	777
Jamming	192
Jeep Type Vehicle	258
Jeep Type Vehicle – Large/Heavy	258
Jeep Type Vehicle - Medium	258
Jeep Type Vehicle – Small/Light	258
Jet Ski	309, 319
Jet Stream	685
Joint Engagement Zone (JEZ)	456
Joint Fire Support	184
Joint Information Bureau (JIB)	199
Joint Intelligence Center	193
Joint Military Symbology	6
Joint Tactical Action Area (JTAA)	417
Joker	6
Judge Advocate General	194
Junk/Dhow	317
Kelp/Seaweed - Area	744
Kelp/Seaweed - Point	744
Kidnapping	225, 383
Kill Box	568
Killing	358
Killing Victim	224
Killing Victims	224
Kingfisher	341
Kingpin Sonobuoy	486
Known Enemy Minefield	589
Known Insurgent Vehicle	260
Labor	194
Laboratory	218
Land Mine	266
Land Mines	266
Land Symbols	165
Landfill	282
Landing Craft	306

MIL-STD-2525D - INDEX

Landing Place	737
Landing Ring	738
Landing Ship	306
Landing Support	209
Landing Zone (LZ)	418
Landslide	380
Lane	588
Large Box Truck	258
Large Bus	257
Large Extension Node	209
Laser	265
Lash Carrier (with Barges)	316
Lateral Boundary	396
Launch	314
Launch Area	466
Launch Area, Ellipse/Circle	467
Launch Point	536
Launched	161
Launched Torpedo	477
Launcher	218
Laundry/Bath	195
Law Enforcement	203, 274
Law Enforcement Operation	371
Law Enforcement Vessel	318
Law Enforment	260
Lead	728
Leader or Leadership	226, 228
Leading Line	742
Leisure Craft, Motorized	318
Leisure Craft, Sailing	318
Less than Lethal	267
Liaison	173
Light	158, 218, 322, 742
Light Line	397
Light not Associated with Thunder	697
Light Vessle/Light Ship	742
Light Wheeled Armored Vehicle	246
Lighter Than Air	150, 151

MIL-STD-2525D - INDEX

Lighthouse	742
Lightning	700
Limit of Advance	435
Limit of Radar Observation	725
Limited Access Area	419
Limited Cross-Country Truck	253
Limits	724, 765
Limits of Undercast	725
Limits of Visual Observation	725
Line DR Trailer Amplifier	30
Line of Bearing AOU Amplifier	30
Line of Contact	412
Line of Departure	436
Line of Departure / Line of Contact	436
Linear Smoke Target	526
Linear Target	526
Linear Targets	526
Lines	391, 669
Linkup Point	405
Liquid Precipitation – Convective	708
Liquid Precipitation - Non-Convective Continuous or Intermittent	708
Littoral Combatant Ship	304
Lock	768
Locomotive	255
LOFAR	486
Logistics	323
Logistics Release Point (LRP)	619
Lollipopping	6
LOMEZ	457
Long Range	139, 159, 162, 218
Loose Dry Dust or Sand not Covering Ground Completely	714
Loose Dry Snow Covering at Least One-Half Ground, but Ground Not Completely Covered	717
Loose Dry Snow Covering Less Than One-Half of Ground	717
Loot	228, 359
Lost Contact	480
Low Altitude	218
Low Earth Orbit (LEO)	136
Low Pressure Center	660

MIL-STD-2525D - INDEX

Low Wire Fence	587
Low-Level Transit Route	450
Machine Gun	230
Machine Gun - Heavy	230
Machine Gun - Light	230
Machine Gun - Medium	230
Mail Server	804
Main Attack	429
Main Equipment Decontamination Point/Site	614
Main Gun System	179, 183
Main Supply Route (MSR)	634
Maintenance	195, 209
Maintenance Collection Point (MCP)	619
Maintenance Facility	290
Maneuver Areas	414
Maneuver Lines	410
Maneuver Points	425
Man-Made Structures	767
Manual Track	135, 152, 268, 325, 339
Many Bergy Bits	720
Many Growlers	720
Many Icebergs	719
Many Icebergs – General	719
Marginal Visual Flight Rule (MVFR)	707
Marine	180, 378
Marine Life	500
Maritime Area	766
Maritime Control Area	466
Maritime Control Lines	501
Maritime Control Points	474
Maritime Limit Boundary	765
Marker	741
Marker Post (Lollipop)	784
Marshall Point	489
Mass Grave Site	272
Material	195
Materiel	272
Mechanized	185, 187, 189

MIL-STD-2525D - INDEX

MEDEVAC	215
Medical	195, 252, 285, 320
Medical Evacuation (MEDEVAC)	145, 154, 252
Medical Evacuation Helicopter	266
Medical Evacuation (MEDEVAC) Pick-up Point	619
Medical Facilities Outpatient	369
Medical Infrastructure	284
Medical Supply Point	629
Medical Treatment Facility	195
Medical Treatment Facility (Hospital)	285
Medium	158, 219, 323
Medium Altitude	219
Medium Earth Orbit (MEO)	136
Medium Range	139, 159, 162, 219
Medium to Low Altitude	222
Meeting	366
Melt Puddles or Flooded Ice	724
Merchant Ship	314
Meteorological	184, 209, 778
Meteorological and Oceanographic Symbols	659
Microbial	382
Midsized	256
MILCO - Bottom	346
MILCO - Bottom, Confidence Level 1	346
MILCO - Bottom, Confidence Level 2	346
MILCO - Bottom, Confidence Level 3	346
MILCO - Bottom, Confidence Level 4	347
MILCO - Bottom, Confidence Level 5	347
MILCO - Floating	348
MILCO - Floating, Confidence Level 1	348
MILCO - Floating, Confidence Level 2	349
MILCO - Floating, Confidence Level 3	349
MILCO - Floating, Confidence Level 4	349
MILCO - Floating, Confidence Level 5	349
MILCO - General, Confidence Level 1	345
MILCO - General, Confidence Level 2	345
MILCO - General, Confidence Level 3	345
MILCO - General, Confidence Level 4	345

MIL-STD-2525D - INDEX

MILCO - General, Confidence Level 5	346
MILCO - Moored	347
MILCO - Moored, Confidence Level 1	347
MILCO - Moored, Confidence Level 2	347
MILCO - Moored, Confidence Level 3	348
MILCO - Moored, Confidence Level 4	348
MILCO - Moored, Confidence Level 5	348
MILCO-General	345
Military	131, 145, 303, 310, 331
Military Armory	285
Military Base	285
Military Combatant	303
Military Information Support Operations (MISO)	173, 265
Military Informations Support Operation (MISO)	365
Military Infrastructure	285
Military Intelligence	193
Military Police	188
Mine	189, 272, 757, 760
Mine Clearing	189
Mine Clearing Equipment	249
Mine Clearing Equipment on Tank Chassis	250
Mine Clearing Equipment Trailer - Mounted	249
Mine Cluster	597
Mine Countermeasure	210
Mine Countermeasures	307, 320, 334
Mine Countermeasures (MCM)	148, 155
Mine Countermeasures, Support Ship	308
Mine Explosion	363
Mine Hunter	307
Mine Launching	189
Mine Layer	307
Mine Laying	189, 366
Mine Laying Equipment	250
Mine Laying Equipment on Utility Vehicle	250
Mine Sweeper	307
Mine Sweeper, Drone	307
Mine Warfare	320, 334
Mine Warfare (MIW) Bottom Descriptors	755

MIL-STD-2525D - INDEX

Mine Warfare Ship	306
Mine Warfare Surface Station	492
Mine Warfare Unmanned Underwater Vehicle Subsurface Station	491
Mine Warfare Unmanned Underwater Vehicle Surface Station	494
Mined Area	592
Minefield	588
Mine-Like Contact (MILCO)	344
Mine-Like Echo (MILEC), General	349
Mine-Like Echo, Bottom	350
Mine-Like Echo, Floating	350
Mine-Like Echo, Moored	350
Miniaturized Satellite	133, 135
Minimum Safe Distance Zone	608
Minimum-Risk Route	450
Missile	138, 159, 161, 183, 184, 210
Missile Acquisition	778
Missile and Space System Production	272
Missile Control	778
Missile Defense	320
Missile Detection Point	477
Missile Downlink	778
Missile Engagement Zone (MEZ)	457
Missile Guidance	779
Missile Homing	779
Missile Launcher - Heavy	236
Missile Launcher - Light	235
Missile Launcher - Medium	236
Missile Launchers	235
Missile Support	263
Missile Tracking	779
Mission Tasks	636
Mist	702
MIW – Fixed Wing	463
MIW – Rotary Wing	463
MIW Bottom Category - A	762
MIW Bottom Category – A1	763
MIW Bottom Category – A2	763
MIW Bottom Category – A3	764

MIL-STD-2525D - INDEX

MIW Bottom Category - B	763
MIW Bottom Category – B1	764
MIW Bottom Category – B2	764
MIW Bottom Category – B3	764
MIW Bottom Category - C	763
MIW Bottom Category – C1	765
MIW Bottom Category – C2	765
MIW Bottom Category – C3	765
MIW-Bottom Sediments - Boulders	758
MIW-Bottom Sediments - Clay	756
MIW-Bottom Sediments – Coarse Sand	756
MIW-Bottom Sediments – Coarse Silt	758
MIW-Bottom Sediments – Cobbles, Oyster Shells	758
MIW-Bottom Sediments – Fine Sand	757
MIW-Bottom Sediments – Fine Silt	757
MIW-Bottom Sediments - Land	759
MIW-Bottom Sediments – Medium Sand	756
MIW-Bottom Sediments – Medium Silt	758
MIW-Bottom Sediments – No Data	759
MIW-Bottom Sediments – Pebbles, Shells	759
MIW-Bottom Sediments – Sand and Shells	759
MIW-Bottom Sediments – Very Coarse Sand	756
MIW-Bottom Sediments – Very Fine Sand	757
MIW-Bottom Sediments – Very Fine Silt	757
Mixed Icing	682
Mixed Icing, Light	682
Mixed Icing, Moderate	683
Mixed Icing, Severe	683
Mobile Advisor and Support	210
Mobile Emergency Physician	252
Mobile Subscriber Equipment	210
Mobility Support	210
Model	784
Moderate/Heavy not Associated with Thunder	697
Moderate/Thick Loose Dry Dust or Sand Covering Ground Completely	715
Modifier	6
Modifiers	19
Molniya Orbit (MO)	136

MIL-STD-2525D - INDEX

Morale, Welfare and Recreation	195
Morgue	369
Mortar	18, 184, 240
Mortar - Heavy	240
Mortar - Light	240
Mortar - Medium	240
Mortar Fire Explosion	364
Mortuary Affairs/Graves Registration	196
Motorize	176
Motorized	179, 180, 185, 187, 190
Mountain	219
Mountain Waves	679
Movable	596
Movable and Prefabricated	596
Movement and Maneuver	175
Movement Control Center	210
Moving Convoy	632
Moving Haven	479
Multi-Channel	219
Multi-Function	778
Multifunctional Earthmover/Digger	249
Multimission	157
Multinational	210
Multinational (MN)	202
Multinational Specialized Unit	210
Multiple Classes of Supply	196
Multiple Passenger Vehicle	257
Multiple Rocket Launcher	211, 241
Multiple Rocket Launcher - Heavy	242
Multiple Rocket Launcher - Light	242
Multiple Rocket Launcher - Medium	242
Munition Flight Path	523
Murder	383
Murder Victims	225
Named Area of Interest	400
Named Headquarters	202
NAPT Other	803
NAPT with C2	802

MIL-STD-2525D - INDEX

NAPT with C2 and Self Propagation	803
NAPT with Self Propagation	803
NATO Class I	623
NATO Class II	624
NATO Class III	624
NATO Class IV	624
NATO Class V	625
NATO Medical Role 1	211
NATO Medical Role 2	211
NATO Medical Role 3	211
NATO Medical Role 4	211
NATO Multiple Supply Class Point.	625
NATO Supply Class I	196
NATO Supply Class II	196
NATO Supply Class III	196
NATO Supply Class IV	197
NATO Supply Class V	197
Natural Event	379
Natural Gas	295
Natural Gas Facility	284
Naval	201, 202, 211
Naval Cargo Ship	312
Naval Stores Ship	311
Navigation/Distance Measuring Equipment	779
Navigation/General	779
Navigation/Terrain Following	779
Navigation/Weather Avoidance	779
Navigational	498
Navigational Reference Point	484, 488
Navigational Satellite	133, 135
Navy Task Element	309
Navy Task Force	309
Navy Task Group	310
Navy Task Organization	309
Navy Task Unit	310
Negative Reacquisition, Bottom	350
Negative Reacquisition, Floating	351
Negative Reacquisition, General	350

MIL-STD-2525D - INDEX

Negative Reacquisition, Moored	351
Network Outage	803, 807
Neutral	6
Neutralize	646
Neutralized Mine, Bottom	343
Neutralized Mine, Floating	343
Neutralized Mine, General	342
Neutralized Mine, Moored	343
Neutralized Mine, Other Position	344
Neutralized Mine, Rising	343
Neutralized Obstructor	351
No Attack (NOTACK) Zone	470
No Fire Area (NFA)	513
No Fire Area (NFA) – Circular	516
No Fire Area (NFA) - Irregular	514
No Fire Area (NFA) – Rectangular	515
No Fire Line	522
Node Center	211
Noise Jammer	777
Non-Advanced Persistent Threat (NAPT)	802
Non-Combatant Surface Station	492
Non-Flammable Gas	376
Non-Government	806
Nongovernmental Organization Member or Nongovernmental Organization	227
Nonlethal Weapon	243
Non-Mine Mine-Like Object (NMLO), General	351
Non-Mine Mine-Like Object, Bottom	352
Non-Mine Mine-Like Object, Floating	352
Non-Mine Mine-Like Object, Moored	352
Non-Residential Fire	374
Nonsubmarine	332
Normal	803
Nuclear	211, 269, 294
Nuclear – Type 1	337
Nuclear – Type 2	337
Nuclear – Type 3	337
Nuclear – Type 4	338
Nuclear – Type 5	338

MIL-STD-2525D - INDEX

Nuclear – Type 6	338
Nuclear – Type 7	338
Nuclear (Non CBRN Defense)	272
Nuclear Contaminated Area	607
Nuclear Event	611
Nuclear Fallout Producing Event	611
Nuclear Material Production	296
Nuclear Material Storage	297
Nuclear Powered	322
Nuclear Powered, General	337
Nuclear Target	525
Objective Area	439
Observation Post /Outpost (Specified)	425
Observation Post /Outpost (Unspecified)	425
Observed Ice Edge or Boundary	726
Observer	179
Obstacle Belt	573
Obstacle Bypass	578
Obstacle Bypass Difficult	579
Obstacle Bypass Easy	579
Obstacle Bypass Impossible	579
Obstacle Effects	574
Obstacle Free Zone	573
Obstacle Line	583
Obstacle Restricted Zone	574
Obstacle Zone	573
Obstructor	351
Occluded Front	666
Occluded Frontolysis	667
Occupied Assembly Area	416
Occupied Assembly Area with Offset Unit	416
Occupied Assembly Area with Offset Units	416
Occupy	647
Oceanographic Research Ship	311
Oceanography	751
Offshore Loading Facility - Area	737
Offshore Loading Facility - Line	737
Offshore Loading Facility - Point	737

MIL-STD-2525D - INDEX

Oil Rig	498
Oil/Gas Rig	768
Oil/Gas Rig Field	769
Oiler, Replenishment	312
Oiler/Tanker	316
Omni-Line of Sight (LOS)	780
One Way Traffic	634, 635
Open Facility (Open Venue)	286
Open-Bed Truck	256
Openings in the Ice	727
Operation	364
Operational Condition Amplifier	31
Operational Decontamination Point/Site	614
Operations	212
Operator Defined	767
Operator-Defined Freeform	710, 712
Optical	137
Optical (Flash)	219
Optical Fix	482
Orbit	464
Orbit – Figure Eight	464
Orbit – Race Track	464
Orbit – Random Closed	464
Orbiter Shuttle	131, 134
Ordnance	197
Organic Peroxide	376
Organization or Group	224
Orientation	39
Other	214, 228
Other Equipment	263
Other Financial Services	280
Other Guided Missile	321, 335
Other Submersible	332
Other Water Supply Location	370
Overcast Coverage	687
Overhead Wire	600
Over-Snow (Prime Mover)	27
Own Ship	319, 324

MIL-STD-2525D - INDEX

Ownship	6
Oxidizer	377
Pack Animal	219
Pack Animals	27, 262
Pairing line Amplifier	31
Passage Point	405
Passenger	149, 153, 316
Patchy	701
Patient Evacuation Coordination	220
Patriot	140, 161
Patrol	146, 154
Patrol Boat	308
Patrol Craft, Submarine Chaser/Escort, General	308
Patrol Ship, General	308
Patrolling	364
Pattern Center Sonobuoy	486
Peer-to-Peer Node	805
Pending	6
Penetrate	648
Penetration Box	441
Perches/Stakes - Area	741
Perches/Stakes - Point	741
Person In Water/	497
Personnel Recovery	148, 155
Personnel Services	197
Petroleum	295
Petroleum, Oil and Lubricant	254
Petroleum, Oil and Lubricants	197
Petroleum/Gas/Oil	284
Pharmaceutical Manufacturer	282
Pharmacy	370
Phase Line	413
Photographic (Reconnaissance)	155
Photographic Reconnaissance	149
Picket Route	495
Picket Surface Station	492
Pickup	256
Pickup - Large	256

MIL-STD-2525D - INDEX

Pickup - Small	256
Pickup Zone (PZ)	418
Pictograph	784
Pier/Wharf/Quay	735
Pile/Piling/Post	769
Pipeline	197
Pipelines/Pipe	769
Piracy	226, 383
Pirate	384
Plan Ship	474
Planet Lander	131
Planned	18, 580
Planned Minefield	589
Plotting	39
Plunder	359
Point	6, 784
Point of Departure	439
Point of Interest	406
Point of Interest – Launch Event	406
Point or Single Target	525
Point R Route	495
Point Targets	525
Points	391
Point-to-Point Line of Sight (LOS)	780
Poisoning	358
Police	204, 262, 275, 372
Polling Place/Election	366
Pop-Up Point (PUP)	460
Ports	733
Ports and Harbors	733
Position and Intended Movement (PIM)	489
Position and Intended Movement (PIM) Route	495
Position Area For Artillery (PAA)	519
Position Area For Artillery (PAA) - Circular	521
Position Area For Artillery (PAA) - Rectangular	520
Possible Submarine - High 3	335
Possible Submarine - High 4	336
Possible Submarine - Low 1	335

MIL-STD-2525D - INDEX

Possible Submarine - Low 2	335
Post Office	286
Postal	198
Postal Distribution Center	286
Postal Service Infrastructure	285
Power Outage	807
Precipitation of Unknown Type and Intensity	707
Predicted Impact Point	477
Predominately Ice Covered	716
Pre-Landfall Waypoint	489
Premature IED Explosion	362
Pressure Systems	660
Pressure Tendency	673
Preventive Maintenance	220
Principal Direction of Fire	414
Printed Media	272
Prison	204, 275, 372
Probable Line of Deployment.	437
Probable Submarine	336
Propane Facility	284
Propellant Transporter	263
Proposed or On Order Assembly Area	416
Proposed or On Order Forward Edge of the Battle Area	413
Protection	185
Protection Areas	572
Protection Lines	582
Protection Points	581
Proximity Fuse	780
Pseudo-Three Dimensional	783
Psychological	220
Public Affairs/Public Information	198
Public Venues Infrastructure	286
Pulsed Jammer	777
Pumping Station	292
Purple Kill Box, Circular	572
Purple Kill Box, Irregular	570
Purple Kill Box, Rectangular	571
Qualifying Terms - Coarse	749

MIL-STD-2525D - INDEX

Qualifying Terms - Fine	749
Qualifying Terms - Medium	749
Quartermaster	198
Radar	137, 212, 267, 773
Radar Search Doctrine	473
Radiation Dose Rate Contour Line	609
Radio	174
Radio Frequency Identification (RFID) Interrogator/Sensor	212
Radio Relay	174
Radio Relay Line of Sight	220
Radio Teletype Center	174
Radioactive Material	377
Radiological	212, 269, 294
Radiological – Toxic Industrial Material	612
Radiological Contaminated Area	607
Radiological Contaminated Area – Toxic Industrial Material	607
Radiological Event	611
Raft Site	603
Rafting	729
Raid on House	367
Rail	378
Railcar	255
Railhead	198
Railhead/Railroad Station	290
Railroad	220
Railway	27
Rain	687
Rain and Snow Mixed	692
Rain and Snow Showers - Light	693
Rain and Snow Showers - Moderate/Heavy	693
Rain or Drizzle and Snow – Light	693
Rain or Drizzle and Snow –Moderate/Heavy	693
Rain Showers	689
Rain Showers, Light	690
Rain Showers, Moderate/Heavy	690
Rain Showers, Torrential	690
Rally Point	406
Ramp - Above Water	738

MIL-STD-2525D - INDEX

Ramp - Below Water	738
Range Only	780
Range Only Sonobuoy	487
Ranger	215
Ransack	359
Rape	226, 384
Rear Boundary	397
Rearm, Refuel and Resupply Point (R3P)	620
Recoilless Gun - Heavy	234
Recoilless Gun - Light	234
Recoilless Gun - Medium	234
Recoilless Guns	234
Reconnaissance	146, 155, 177, 178, 186, 188
Reconnaissance and Surveillance	180
Reconnaissance Armored	186
Reconnaissance Equiped	186
Reconnaissance Outpost	425
Reconnaissance Satellite	133
Reconnaissance/Cavalry/Scout	177
Reconnaissance/Cavalry/Scout	179
Recovery (Maintenance)	220
Recovery (Unmanned Systems)	220
Recreational Area	287
Recruitment	365
Rectangular Target	528
Rectangular Target – Single Target	530
Reef	746
Re-entry Vehicle	131
Reference Point	487
Refuel	222
Refuel On the Move (ROM) Point	620
Refugee Holding Area	630
Regimental Support Area	631
Release Line	446
Release Point	407
Relief in Place (RIP)	649
Religious Institution	287
Religious Leader	382

MIL-STD-2525D - INDEX

Religious or Religious Organization	227
Religious Support	198
Reload Point	536
Remote Multimission Vehicle (RMV)	320
Remote Multi-Mission Vehicle Unmanned Underwater Vehicle Surface Station	494
Remote Piloted Vehicle (RPV)	150, 151
Remotely Piloted	324, 338
Rendezvous Route	496
Rendezvous Surface Station	492
Repair Ship	313
Repeater Jammer	778
Replacement Holding Unit	198
Replenishment at Sea Surface Station	493
Replenishment Station	462
Reported Bottomed Sub	479
Reptile	382
Rescue	463
Rescue Coordination Center	220
Rescue Surface Station	493
Reservoir	293
Residential Fire	374
Rest Stop	290
Restricted Area	766
Restricted Fire Area (RFA)	516
Restricted Fire Area (RFA) – Circular	519
Restricted Fire Area (RFA) - Irregular	517
Restricted Fire Area (RFA) – Rectangular	518
Restricted Operating Zone (ROZ)	454
Restrictive Fire Line	523
Retain	423
Retire/ Retirement	650
Ridge Axis	670
Ridges or Hummocks	729
Rifles	229
Rigid-Hull Inflatable Boat (RHIB)	309, 318
Rime Icing	681
Rime Icing, Light	681
Rime Icing, Moderate	681

MIL-STD-2525D - INDEX

Rime Icing, Severe	682
Rise	675
Rise Then Fall Higher	674
Rise Then Fall Lower	677
Rise Then Rise Higher	675
Rise Then Steady	674
Riverine	221
Roadblock Complete (Executed)	581
Roadblocks, Craters and Blown Bridges	580
Robbery	360
Rock Awashed	743
Rock Submerged	743
Rock Throwing	360
Rocket Explosion	364
Rodent	382
Roll On/Roll Off	315
Rolling Airframe Missile (RAM)	162
Rotary-Wing	150, 151
Router	804
Sabotage	361
Safe House	273
Safe Lane	451
Sastrugi (with Orientation)	729
Satellite	132, 134
Satellite Downlink	780
Satellite Uplink	781
Satellite, General	132
Scattered Coverage	686
School	283
School Fire	374
Screen	653
Screen Center	480
Sea Air Land (SEAL)	180
Sea Anomaly (Wake, Current, Knuckle)	500
Sea Ice	723
Sea Mine Decoy	344
Sea Mine Decoy, Bottom	344
Sea Mine Decoy, Moored	344

MIL-STD-2525D - INDEX

Sea Mine, Bottom	340
Sea Mine, Floating	340
Sea Mine, General	340
Sea Mine, Moored	340
Sea Mine, Other Position	341
Sea Mine, Rising	340
Sea Mine-Like	499
Sea Port/Naval Base	290
Sea Surface Symbols	299
Sea-Base X-Band	322
Sea-Based X-Band (SBX) Radar	310
Seaport of Debarkation/ Seaport of Embarkation	198
Search	192, 193, 483
Search and Rescue	148, 156, 190, 212
Search Area	483
Search Area/Reconnaissance Area	444
Search Center	483
Seawall	740
Secure	651
Security	189, 212, 651
Security Police (Air)	190
Sedan	256
Seize	653
Self-Propelled	183
Self-Propelled Tracked	184
Semiautomatic Rifle	229
Semi-Trailer and Truck	253
Semi-Trailer and Truck - Light	253
Sensor	193, 212, 267
Sensor Control Module (SCM)	212
Sensor Emplaced	267
Sensor Outpost/Listening Post	426
Sensor Zone	552
Sensor Zone, Circular	555
Sensor Zone, Irregular	553
Sensor Zone, Rectangular	554
Sensors	267
Series or Group of Targets	531

MIL-STD-2525D - INDEX

Service Craft/Yard	313
Service Outage	807
Severe Squall Line	671
Shallow Continuous	701
Shallow Patches	700
Shear Line	672
Shearing or Shear Zone	723
Shell Tracking	781
Shelter	603
Ship Area of Interest	470
Ship Area of Interest, Eclipse/Circle	471
Ship Area of Interest, Rectangle	472
Ship Yard	291
Shooting	362
SHORADEZ	458
Shore Control Station	494
Shore Patrol	190
Shoreline Protection	739
Short Range	139, 158, 162, 221
SIDC	7
Signal	174
Signal - Radio	174
Signal - Radio Relay	174
Signal - Tactical Satellite	175
Signal - Teletype	174
Signal - Video Imagery (Combat Camera)	175
Signal Intercept	773
Signals Intelligence Symbols	771
Signals Intelligence	213
Signals Intelligence (SIGINT)	137
Single Channel	221
Single Concertina	587
Single Fence	586
Single Rocket Launcher	213, 241
Single Rocket Launcher - Heavy	241
Single Rocket Launcher - Light	241
Single Rocket Launcher - Medium	241
Single Shelter Switch	213

MIL-STD-2525D - INDEX

Single Shot Rifle	229
Sinker	480
Ski	221
Sky Obscured	701
Sky Totally or Partially Obscured	687
Sky Visible	701
Sled	27
Small Box Truck	258
Small Bus	257
Small Object, Mine-Like	341
Smoke	213, 374, 532, 702
Smoke Planned or On Order	532
Smuggling	360
Snags/Stumps	745
Sniper	180, 213
Sniping	362
Snow	693
Snow Cover	728
Snow Covering Ground Completely, Deep Drifts	718
Snow Grains	696
Snow Showers	696
Snow Showers, Light	696
Snow Showers, Moderate/Heavy	696
Solid (Volume)	784
Sonobuoy	484, 780
Sound Ranging	213
Soundings	730
Space	138, 140, 160, 161, 769, 780
Space Launched Vehicle (SLV)	133
Space Station	133, 135
Space Symbols	127
Space Vehicle	131
Speaker	227, 382
Special Boat	182
Special Forces	181
Special Needs Fire	374
Special Needs Infrastructure	287
Special Operations Forces	149

MIL-STD-2525D - INDEX

Special Operations Forces (SOF)	156, 181, 213, 320, 335
Special Point	408, 487
Special SSNR	182
Special Weapons and Tactics	213
Speed Leader Amplifier	30
Speedboat	309, 318
Spontaneously Combustible Material	377
Sport Utility Vehicle (SUV)	257
Spot Noise Jammer	778
Spy	224, 366
Squall	700
Staff	6
Standard Missile – 2 (SM-2)	162
Standard Missile – 3 (SM-3)	140
Standard Missile – 6 (SM-6)	162
Standard Missile Terminal Phase (SM-T)	140
Standard Use Army Aircraft Flight Route (SAAFR)	451
Start Point	408
State of the Ground	712
Static Amplifier	6
Stationary Front	668
Stationary Frontogenesis	669
Stationary Frontolysis	669
Steady	676
Storage Tower	293
Storms	698
Strategic	221
Stream Line	685
Strike Initial Point	461
Strong Point	421
Submarine	331
Submarine Action Area (SAA)	417
Submarine Antisubmarine Warfare Subsurface Station	490
Submarine Cable	767
Submarine- Generated Action Area (SGAA)	417
Submarine Subsurface Station	490
Submarine Tender	313
Submarine, Bottomed	332

MIL-STD-2525D - INDEX

Submarine, Snorkeling	331
Submarine, Surfaced	331
Submerged Crib	767
Submersible	332
Subsidence	380
Subsurface	160, 161
Subsurface Symbols	327
SUCAP – Fixed Wing	462
SUCAP – Rotary Wing	462
Supervisory Control and Data Acquisition (SCADA)	806
Supply	199
Support	215, 221
Support by Fire Position	443
Supporting Attack	430
Supporting Attack Planned or On Order	431
Suppression of Enemy Air Defense	149, 156
Surface	160, 161
Surface (Area)	784
Surface Combatant, Line	303
Surface Dry without Cracks or Appreciable Dust or Loose Sand	713
Surface Flooded	714
Surface Frozen	714
Surface Moist	713
Surface Search	781
Surface Warfare	156, 321, 334
Surface Warfare Surface Station	493
Surface Warfare Unmanned Underwater Vehicle Subsurface Station	491
Surface Warfare Unmanned Underwater Vehicle Surface Station	494
Surface Water Intake	293
Surface Wet, Standing Water in Small or Large Pools	713
Surface-to-Surface Missile Launcher	239
Surface-to-Surface Missile Launcher - Heavy	240
Surface-to-Surface Missile Launcher - Light	239
Surface-to-Surface Missile Launcher - Medium	239
Surveillance	181
Survey	185, 214
Survey Control Point	537
Survey Ship	312

MIL-STD-2525D - INDEX

Suspect	7
Suspected or Templated Enemy Minefield	589
Suspicious Activity	361
Sustainment	193, 194
Sustainment Areas	629
Sustainment Lines	632
Sustainment Points	615
Sustainment Shipments	265
Swept Area	766
Switch	805
Symbicon	784
Symbol	7, 784
Symbol Identification Code (SIDC)	7
Symbol Identification Codes	45
TACAN	461
Tactical	221
Tactical Exploitation	214
Tactical Satellite	175
Tagert Acquisition	183
Tank	18, 246, 323
Tank - Heavy	246
Tank - Light	246
Tank - Medium	246
Tank Recovery Vehicle	247
Tank Recovery Vehicle - Heavy	247
Tank Recovery Vehicle - Light	247
Tank Recovery Vehicle - Medium	247
Tanker	146, 153
Tanking	462
Target Acquisition	214, 781
Target Area of Interest	400
Target Build-up Area	555
Target Build-up Area, Circular	558
Target Build-up Area, Irregular	556
Target Build-up Area, Rectangular	557
Target Illumination	781
Target Reference Point	427
Target Tracking	781

MIL-STD-2525D - INDEX

Target Value Area	558
Target Value Area, Circular	561
Target Value Area, Irregular	559
Target Value Area, Rectangular	560
Targeted Individual or Organization	227
Target-Recorded	526
Taser	243
Telecommunications (Civilian)	288
Telecommunications Infrastructure	288
Telecommunications Tower	288
Tent	265
Tentative or Provisional Track	496
Tented Camp	273
Terminal High Altitude Area Defense (THAAD)	140
Terminally Guided Munition Footprint (TGMF)	565
Terrain Draping	784
Terrorist or Terrorist Organization	227
Tethered Lighter than Air	151, 152
Tethered Satellite	133, 135
Tetrahedrons, Dragons Teeth, and Other Similar Obstacles	596
Text	7
Text Modifiers	28
Theater/Echelons Above Corps Support	205
Theft	360, 385
Thickness	712
Thin Loose Dry Dust or Sand Covering Ground Completely	715
Thorough De-contamination Point/Site	614
Three-Dimensional	784
Thunderstorm - No Precipitation	698
Thunderstorm Heavy - with Hail	699
Thunderstorm Heavy with Rain/Snow - No Hail	699
Thunderstorm Light to Moderate - with Hail	699
Thunderstorm Light to Moderate with Rain/Snow - No Hail	699
Thunderstorms	709
Tide and Current	750
Tide Data Point	751
Tide Gauge	751
Toll Facility	291

MIL-STD-2525D - INDEX

Tomcat	463
Topographic	190, 214
Topographical Features	729
Torpedo	321, 333
Tow	316
Tow Truck	254
Tow Truck - Heavy	255
Tow Truck - Light	254
Towed	27, 185, 221
Towed Sonar Array (Long)	28
Towed Sonar Array (Short)	28
Tower, High	599
Tower, Low	599
Toxic Gas	377
Toxic Infectious Material	377
Toxic Release Inventory	282
Track	7
Tracked	26
Tractor Trailer Truck with Box	259
Tractor Trailer Truck with Box - Large/Heavy Box Trailer	259
Tractor Trailer Truck with Box - Small/Light Box Trailer	259
Tractor Trailer Truck with Box - Medium Box Trailer	259
Tractor Trailer Truck with Flatbed Trailer	259
Tractor Trailer Truck with Flatbed Trailer - Heavy	260
Tractor Trailer Truck with Flatbed Trailer - Medium	260
Tractor Trailer Truck with Flatbed Trailer - Small/Light	260
Traffic Control Post (TCP)	621
Traffic Inspection Facility	291
Trafficking	363
Trailer Transfer Point (TTP)	621
Train	255
Trainer	147, 155
Training Area	766
Training Camp	273
Transit Corridors	452
Transloader	263
Transponder Jammer	778
Transport Ship, Hazardous Material	316

MIL-STD-2525D - INDEX

Transportation	199
Transportation Incident	378
Transportation Infrastructure	289
Transportation Security Administration (TSA)	204, 262, 276, 373
Transporter	263
Trawler	317
Triage	370
Trial Track	480
Trip Wire	598
Triple Strand Concertina	587
Troop	222
Troop De-contamination Point/Site	613
Tropical Depression	704
Tropical Storm	705
Tropical Storm Systems	704
Tropical Storm Wind Areas and Date/Time Labels	705
Tropopause High	662
Tropopause Level	706
Tropopause Low	661
Tropospheric Scatter	781
Trough Axis	670
Truck Mounted with Volcano	250
Tsunami	381
Tug, Harbor	314
Tug, Ocean Going	313, 316
Tunnel	291
Turbulence	677, 707
Turbulence , Light	678
Turbulence, Extreme	679
Turbulence, Moderate	678
Turbulence, Severe	678
Turn	578
TV and Radio Propaganda	365
Two Way Traffic	634, 635
Two-Dimensional	784
Ultra Light	149, 154
Underwater Danger/Hazard	743
Underwater Demolitions Team	182

MIL-STD-2525D - INDEX

Uneven Layer of Compact or Wet Snow Covering Ground Completely	717
Uneven Layer of Loose Dry Snow Covering Ground Completely	718
Unexploded Explosive Ordnance (UXO) Area	593
Unexploded Ordnance	344, 378
Unit Deployment Shipments	266
Unit Maintenance Collection Point (UMCP)	622
United States Secret Service (USSS)	372
United States Secret Service(Treas) (USSS)	204, 262, 275
University	283
Unknown	7, 19, 781, 803
Unmanned Aerial System (UAS/UA)	463
Unmanned Aerial Systems	182
Unmanned Aircraft (UA)	150, 151
Unmanned Aircraft (UA) Route	452
Unmanned Aircraft Restricted Operations Zone (UAROZ)	455
Unmanned Aircraft System (UAS)	150, 151
Unmanned Surface Water Vehicle (USV)	308, 319
Unmanned Underwater Vehicle Subsurface Station	491
Unmanned Underwater Vehicle Surface Station	493
Unspecified	586
Unspecified Mine	595
Upgraded Early Warning Radar	269
Upper Cold Front	663
Upper Occluded Front	667
Upper Stationary Front	668
Upper Trough Axis	670
Upper Warm Front	665
US Class I	625
US Class II	626
US Class III	626
US Class IV	626
US Class IX	628
US Class V	627
US Class VI	627
US Class VII	627
US Class VIII	628
US Class X	628
US Marshals Service	205, 262, 276, 373

MIL-STD-2525D - INDEX

US Supply Class I	199
US Supply Class II	199
US Supply Class III	199
US Supply Class IV	200
US Supply Class IX	201
US Supply Class V	200
US Supply Class VI	200
US Supply Class VII	200
US Supply Class VIII	200
US Supply Class X	201
Utility	147, 153, 214, 223, 252
Utility Vehicle	252, 257
Van	257
Vandalism	359
Vdr Level 1-2	751
Vdr Level 2-3	752
Vdr Level 3-4	752
Vdr Level 4-5	752
Vdr Level 5-6	753
Vdr Level 6-7	753
Vdr Level 7-8	753
Vdr Level 8-9	753
Vdr Level 9-10	754
Vehicle	244, 323, 378
Vertical Line Array Directional Frequency Analysis and Recording (DIFAR) Sonobuoy	487
Vertical Obstructions	598
Vertical Take-off and Landing (VTOL/VSTOL)	222
Vertical-Takeoff UAV (VT-UAV)	150
Very Important Person (VIP)	149
Very Important Person (VIP) Transport	156
Veterinary	222
Victim of an Attempted Crime	224
Video Imagery (Combat Camera)	175, 214
Video Remoting	782
Virtual Private Network (VPN)	805
Vital Area Center	488
Volcanic Ash	706
Volcanic Eruption	380, 706

MIL-STD-2525D - INDEX

Volcanic Threat	380
VSTOL	147
VSTOL/VTOL	153
VTUA	464
Warehouse/Storage Facility	273
Warhead Transporter	263
Warm Front	664
Warm Frontogenesis	665
Warm Frontolysis	666
Warrant Served	366
Wastewater Treatment Facility	293
Water	201, 254, 293, 732
Water Cannon	244
Water Purification	201
Water Supply Infrastructure	291
Water Treatment	294
Water Turbulence	750
Water with Radar Targets	722
Waypoint	409, 490
Waypoint Route	496
Weapon	152, 333
Weapon Engagement Zone	455
Weapon/Sensor Range fan, Circular	566
Weapon/Sensor Range fan, Sector	567
Weapon/Weapon System	229
Weapons Free Zone	459
Weapons Grde Production	297
Weather Satellite	133, 135
Weather Symbols	687
Web Server	804
Wheeled	222
Wheeled (Cross-Country)	26
Wheeled (Limited Cross-Country)	26
Wheeled and Tracked Combination	26
Wheeled Vehicle Explosion	379
White List Location	273
Wide Area Antitank Mine	595
Wild Fire	374

MIL-STD-2525D - INDEX

Willing	365
Willing Recruit	227
Wind Plot	684
Winds	683
Wire Obstacles	586
With Snow or Measurable Ice Cover	715
Withdraw	655
Withdraw Under Pressure	655
Without Snow or Measurable Ice Cover	713
Wounded Personnel De-contamination Site	615
Wreck (Submerged)	745
Wreck (Uncovers)	745
Written Military Information Support Operations	384
Zombie	801
Zone of Responsibility	561
Zone of Responsibility, Circular	564
Zone of Responsibility, Irregular	562
Zone of Responsibility, Rectangular	563

MIL-STD-2525D - INDEX

CONCLUDING MATERIAL

Custodians:

Army – AC
Navy – OM
Air Force – 93
NGA – MP

Preparing activity:

DISA – DC3
(INST-2014-004)

NOTE: The activities listed above were interested in this document as of the date of this document. Since organizations and responsibilities can change, you should verify the currency of the information above using the ASSIST Online database at <https://assist.dla.mil>.